



**EMERSON**<sup>™</sup>

Original Instructions  
4000840 - REV. 03



## DCX V Power Supply

# Operating Manual

**Branson Ultrasonics Corp.**  
120 Park Ridge Road  
Brookfield, CT 06804  
(203) 796-0400  
<http://www.bransonultrasonics.com>

**BRANSON**

## Manual Change Information

At Branson, we strive to maintain our position as the leader in ultrasonics plastics joining, metal welding, cleaning and related technologies by continually improving our circuits and components in our equipment. These improvements are incorporated as soon as they are developed and thoroughly tested.

Information concerning any improvements will be added to the appropriate technical documentation at its next revision and printing. Therefore, when requesting service assistance for specific units, note the Revision information found on this document, and refer to the printing date which appears on this page.

## Copyright and Trademark Notice

Copyright © 2026 Branson Ultrasonics Corporation. All rights reserved. Contents of this publication may not be reproduced in any form without the written permission of Branson Ultrasonics Corporation.

Mylar is a registered trademark of DuPont Teijin Films.

Loctite is a registered trademark of Loctite Corporation.

WD-40 is a registered trademark of WD-40 Company.

Windows 10, Windows 11, and Microsoft Edge are registered trademarks of Microsoft Corporation.

Google Chrome is a trademark of Google LLC.

Other trademarks and service marks mentioned herein are held by their respective owners.

## Foreword

Congratulations on your choice of a Branson Ultrasonics Corporation system!

The Branson DCX V Power Supply system is process equipment for the joining of plastic parts using ultrasonic energy. It is the newest generation of product using this sophisticated technology for a variety of customer applications. This Operating Manual is part of the documentation set for this system, and should be kept with the equipment.

Thank you for choosing Branson!

## Introduction

This manual is arranged into several structured chapters which will help you find the information you may need to know to safely handle, install, set up, program, operate, and/or maintain this product. Please refer to the [Table Of Contents](#) and/or the [Index](#) of this manual to find the information you may be looking for. In the event you require additional assistance or information, please contact our Product Support department (see [1.3 How to Contact Branson](#) for information on how to contact them) or your local Branson representative.



---

# Table Of Contents

---

## Chapter 1: Safety and Support

1.1 Safety Requirements and Warnings . . . . .	2
1.2 General Precautions . . . . .	5
1.3 How to Contact Branson . . . . .	8

## Chapter 2: Introduction

2.1 Models Covered . . . . .	14
2.2 Compatibility with other Branson Products . . . . .	17
2.3 Features . . . . .	18
2.4 Controls and Indicators . . . . .	20
2.5 Welding Systems . . . . .	22
2.6 Glossary . . . . .	23

## Chapter 3: Delivery and Handling

3.1 Shipping and Handling . . . . .	26
3.2 Receiving . . . . .	27
3.3 Unpacking the Power Supply . . . . .	28
3.4 Take Inventory of Small Parts . . . . .	29
3.5 Returning Equipment . . . . .	30

## Chapter 4: Technical Specifications

4.1 Technical Specifications . . . . .	32
4.2 Physical Description . . . . .	35
4.3 EU Declaration of Conformity . . . . .	36
4.4 UK Declaration of Conformity . . . . .	37
4.5 Standard Modules and Components . . . . .	38

## Chapter 5: Installation and Setup

5.1 About Installation . . . . .	42
5.2 Installation Requirements . . . . .	43
5.3 Installation Steps . . . . .	50
5.4 Power Supply Configuration . . . . .	66
5.5 Assembling the Acoustic Stack . . . . .	67
5.6 Converter Cooling . . . . .	72
5.7 Testing the Installation . . . . .	74
5.8 Still Need Help? . . . . .	75

## Chapter 6: Converters and Boosters

6.1 Converters and Boosters . . . . .	78
---------------------------------------	----

## Chapter 7: Operation

7.1 Activating Ultrasonic Power . . . . .	90
7.2 Setting the Amplitude . . . . .	91
7.3 Resetting the Power Supply Alarms . . . . .	92
7.4 Web Page Interface . . . . .	93
7.5 Ultrasonics Test Procedure . . . . .	97

## Chapter 8: Maintenance

8.1 General Maintenance Considerations . . . . .	102
--	-----

8.2	Preventive Maintenance . . . . .	104
8.3	Calibration . . . . .	110
8.4	Recommended Spare Stock . . . . .	111
8.5	Circuit Diagram . . . . .	117
8.6	Troubleshooting . . . . .	118
8.7	Cold Start Procedure . . . . .	123
 <b>Appendix A: Timing Diagrams</b>		
A.1	Timing Diagrams . . . . .	126
 <b>Appendix B: Signal Diagrams</b>		
B.1	Signal Diagrams . . . . .	128
 <b>Appendix C: DCX Alarms</b>		
C.1	DCX Alarms . . . . .	130
 <b>Appendix D: Manual's Revisions</b>		
D.1	Manual's Revisions . . . . .	134

# List Of Figures

## Chapter 1: Safety and Support

Figure 1.1	Safety-related Labels found on the DCX V Power Supply (Horizontal)	4
Figure 1.2	Safety-related Labels found on the DCX V Power Supply (Vertical)	4

## Chapter 2: Introduction

Figure 2.1	The DCX V Power Supply (Horizontal)	15
Figure 2.2	The DCX V Power Supply (Vertical)	15
Figure 2.3	DCX V Power Supply Front Panel Indicators	20
Figure 2.4	DCX V Power Supply Back Panel (Horizontal)	21
Figure 2.5	DCX V Power Supply Bottom Panel (Vertical)	21

## Chapter 3: Delivery and Handling

### Chapter 4: Technical Specifications

Figure 4.1	EU Declaration of Conformity	36
Figure 4.2	UK Declaration of Conformity	37
Figure 4.3	System Block Diagram	38

### Chapter 5: Installation and Setup

Figure 5.1	DCX V Power Supply Benchtop Dimensional Drawing	44
Figure 5.2	DCX V Power Supply Vertical Mount Dimensional Drawing (400 W, 750 W and 800 W)	45
Figure 5.3	DCX V Power Supply Vertical Mount Dimensional Drawing (1.25 kW and 1.5 kW)	46
Figure 5.4	DCX V Power Supply Vertical Mount Dimensional Drawing (2.5 kW and 4 kW)	47
Figure 5.5	DCX V Power Supply Connections (Horizontal Model)	52
Figure 5.6	DCX V Power Supply Connections (Vertical Model)	53
Figure 5.7	User I/O Cable Identification and Wire Color Diagram	55
Figure 5.8	Typical Digital I/O Wiring Examples	62
Figure 5.9	Typical Analog I/O Wiring Examples	62
Figure 5.10	RF Cable Connection	63
Figure 5.11	Assembling the Acoustic Stack	68
Figure 5.12	Connecting Tip to Horn	71

### Chapter 6: Converters and Boosters

Figure 6.1	20 kHz typical Converter Dimensions	79
Figure 6.2	20 kHz Booster Dimensions	80
Figure 6.3	20 kHz Converter/Booster/Horn, Typical Dimensions	81
Figure 6.4	30 kHz Converter Dimensions	82
Figure 6.5	30 kHz Booster Dimensions	83
Figure 6.6	30 kHz Converter/Booster/Horn, Typical Dimensions	84
Figure 6.7	40 kHz Booster Dimensions	85
Figure 6.8	40 kHz Converter/Booster/Horn, Typical Dimensions	86

### Chapter 7: Operation

Figure 7.1	Test Connections	98
------------	------------------	----

### Chapter 8: Maintenance

Figure 8.1	Reconditioning Stack Mating Surfaces	106
Figure 8.2	Interconnect Diagram, Power Supply	117

## **Appendix A: Timing Diagrams**

Figure A.1	Weld Cycle. . . . .	126
Figure A.2	Weld Cycle. . . . .	126
Figure A.3	Weld Cycle. . . . .	126

## **Appendix B: Signal Diagrams**

Figure B.1	Continuous Mode . . . . .	128
------------	---------------------------	-----

## **Appendix C: DCX Alarms**

## **Appendix D: Manual's Revisions**

Figure D.1	Manufacturing date on the Information label . . . . .	134
Figure D.2	Location of the Information label on the back of the DCX V Power Supply Horizontal . . . . .	135
Figure D.3	Location of the Information label on the top of the DCX V Power Supply Vertical . . . . .	135

# List Of Tables

## Chapter 1: Safety and Support

Table 1.1	Authorized Service Center (North America)	8
Table 1.2	Authorized Service Centers (South America)	8
Table 1.3	Authorized Service Centers (Asia)	9
Table 1.4	Authorized Service Centers (Europe)	11

## Chapter 2: Introduction

Table 2.1	Models Covered In This Manual	14
Table 2.2	Power Supply Compatibility with Branson Converters	17
Table 2.3	DCX V Power Supply Front Panel Indicators	20
Table 2.4	Connections to the DCX V Power Supply	21

## Chapter 3: Delivery and Handling

Table 3.1	Shipping Specifications	26
Table 3.2	Inspect the Power Supply	27
Table 3.3	Unpacking the Power Supply	28
Table 3.4	Small Parts included (=x) Power Supply Assemblies	29
Table 3.5	DCX V Power Supply System Cables	29

## Chapter 4: Technical Specifications

Table 4.1	Environmental Specifications	32
Table 4.2	Electrical Input Operating Voltages	33
Table 4.3	Input Current and Circuit Breaker Specifications	33
Table 4.4	Continuous Duty Max. Power	33
Table 4.5	Dimension and Weight of DCX V Power Supply	35

## Chapter 5: Installation and Setup

Table 5.1	Environmental Requirements	48
Table 5.2	Input Current and Circuit Breaker Specifications	48
Table 5.3	DCX V Power Supply Connections (Horizontal Model)	52
Table 5.4	DCX V Power Supply Connections (Vertical Model)	53
Table 5.5	User I/O Cable Pin assignments	56
Table 5.6	Available Digital Input Functions	57
Table 5.7	Available Digital Output Functions	58
Table 5.8	Available Analog Input Functions	59
Table 5.9	Available Analog Output Functions	60
Table 5.10	Default User I/O Connector Pin Assignments	61
Table 5.11	RF Cable Connection	63
Table 5.12	Input Power Connection	64
Table 5.13	Acoustic Stack Description	68
Table 5.14	Stack Torque Values	68
Table 5.15	Tools	69
Table 5.16	20 kHz System	70
Table 5.17	30 kHz System	70
Table 5.18	40 kHz System	70
Table 5.19	Tip to Horn Values	71
Table 5.20	Continuous Duty Max. Power & Full Power Duty Cycle	72
Table 5.21	Converter Cooling Procedure	73

## Chapter 6: Converters and Boosters

Table 6.1	20 kHz Converter . . . . .	79
Table 6.2	20 kHz Booster. . . . .	80
Table 6.3	20 kHz Converter/Booster/Horn . . . . .	81
Table 6.4	30 kHz Converter . . . . .	82
Table 6.5	30 kHz Booster. . . . .	83
Table 6.6	30 kHz Converter/Booster/Horn . . . . .	84
Table 6.7	40 kHz Booster. . . . .	85
Table 6.8	40 kHz Converter/Booster/Horn . . . . .	86

## Chapter 7: Operation

Table 7.1	Resetting the DCX V Power Supply . . . . .	92
Table 7.2	Power Supply Ultrasonic Test Procedure (User I/O). . . . .	98
Table 7.3	Power Supply Ultrasonic Test Procedure (Web Page Interface) . . . . .	99

## Chapter 8: Maintenance

Table 8.1	Stack Reconditioning Procedure . . . . .	105
Table 8.2	Reconditioning Stack Mating Surfaces . . . . .	106
Table 8.3	Stack Torque Values . . . . .	107
Table 8.4	Stack Reassembly for a 20 kHz System. . . . .	107
Table 8.5	Stack Reassembly for a 30 kHz System. . . . .	108
Table 8.6	Stack Reassembly for a 40 kHz System. . . . .	108
Table 8.7	Stud Torque Values. . . . .	109
Table 8.8	DCX V Power Supply System Cables . . . . .	111
Table 8.9	Suggested Spares. . . . .	112
Table 8.10	Converters Compatible with the DCX V Power Supply . . . . .	113
Table 8.11	DCX V Power Supply Compatible Boosters . . . . .	114
Table 8.12	Other Items used with the DCX V Power Supply. . . . .	116
Table 8.13	Troubleshooting . . . . .	118
Table 8.14	Troubleshooting Common Electrical Problems. . . . .	119
Table 8.15	Troubleshooting Fan/Power Switch Problems . . . . .	120
Table 8.16	Troubleshooting Ultrasonic Power Problems . . . . .	121
Table 8.17	Troubleshooting Weld Cycle Problems . . . . .	122
Table 8.18	Steps to Perform a Cold Start. . . . .	123

## Appendix A: Timing Diagrams

## Appendix B: Signal Diagrams

## Appendix C: DCX Alarms

Table C.1	DCX V Alarms . . . . .	130
-----------	------------------------	-----

## Appendix D: Manual's Revisions

Table D.1	Manual's Revisions . . . . .	134
-----------	------------------------------	-----

---

# Chapter 1: Safety and Support

---





<b>1.1</b>	<b>Safety Requirements and Warnings</b> .....	<b>2</b>
<b>1.2</b>	<b>General Precautions</b> .....	<b>5</b>
<b>1.3</b>	<b>How to Contact Branson</b> .....	<b>8</b>



## 1.1 Safety Requirements and Warnings

This chapter contains an explanation of the different Safety Notice symbols and icons found both in this manual and on the product itself and provides additional safety information for ultrasonic welding. This chapter also describes how to contact Branson for assistance.

### 1.1.1 Symbols Found in this Manual

These symbols used throughout this manual warrant special attention:

<b>WARNING</b>	<b>Indicates a possible danger</b>
	If these risks are not avoided, death or severe injury might result.
<b>WARNING</b>	<b>High Voltage Hazard</b>
	High voltage. Turn power off before servicing.
<b>WARNING</b>	<b>Corrosive Material Hazard</b>
	Corrosive material. Avoid contact with eyes and skin. Wear proper protection.
<b>CAUTION</b>	<b>Indicates a possible danger</b>
	If these risks are not avoided, slight or minor injury might result.

<p><b>CAUTION</b></p>	<p><b>Loud Noise Hazard</b></p>
	<p>Loud noise hazard. Ear protection must be worn.</p>
<p><b>CAUTION</b></p>	<p><b>Heavy Object</b></p>
	<p>Heavy object. To avoid muscle strain or back injury, use lifting aids and proper lifting techniques.</p>
<p><b>NOTICE</b></p>	<p><b>Indicates a possible damaging situation</b></p>
	<p>If this situation is not avoided, the system or something in its vicinity might get damaged.</p> <p>Application types and other important or useful information are emphasized.</p>

## 1.1.2 Symbols Found on the Product

The DCX V Power Supply has several safety-related labels on it to indicate the presence of hazardous voltages inside the unit.

**Figure 1.1** Safety-related Labels found on the DCX V Power Supply (Horizontal)



**Figure 1.2** Safety-related Labels found on the DCX V Power Supply (Vertical)





## 1.2 General Precautions

Take the following precautions before servicing the power supply:

- Be sure the power switch is in the off position before making any electrical connections
- To prevent the possibility of an electrical shock, always plug the power supply into a grounded power source
- To prevent the possibility of an electrical shock, ground the power supply by securing an 8 gage grounded conductor to the ground screw located next to the air outlet
- Power supplies produce high voltage. Before working on the power supply assembly, do the following:
  - Turn off the power supply;
  - Unplug main power; and
  - Allow at least 5 minutes for capacitors to discharge
- High voltage is present in the power supply. Do not operate with the cover removed
- High line voltages exist in the ultrasonic power supply assembly. Common points are tied to circuit reference, not chassis ground. Therefore, use only non-grounded, battery-powered multimeters when testing the power supply assembly. Using other types of test equipment can present a shock hazard
- Keep hands from under the horn. Down force (pressure) and ultrasonic vibrations can cause injury
- Do not cycle the welding system if either the RF cable or converter is disconnected
- When using larger horns, avoid situations where fingers could be pinched between the horn and the fixture
- Ensure power supply installation is performed by qualified personnel and in accordance with local standards and regulations

CAUTION	Loud Noise Hazard
	<p>Sound level and frequency of the noise emitted during the ultrasonic assembly process may depend upon <b>a.</b> type of application, <b>b.</b> size, shape and composition of the material being assembled, <b>c.</b> shape and material of the holding fixture, <b>d.</b> welder setup parameters and <b>e.</b> tool design.</p> <p>Some parts vibrate at an audible frequency during the process. Some or all of these factors may result in an uncomfortable noise being emitted during the process.</p> <p>In such cases operators may need to be provided with personal protective equipment. See 29 CFR (Code of Federal Regulations) 1910.95 Occupational Noise Exposure.</p>

NOTICE	
	<p>When the battery is worn out, dispose it under the ordinance of each local government.</p>

WARNING	Corrosive Material Hazard
	<p>First aid measures (in case of electrolyte leakage from the battery):</p> <p><b>Eye Contact:</b> Flush the eyes with plenty of clean water for at least 15 minutes immediately, without rubbing. Get immediate medical treatment.</p> <p>If appropriate procedures are not taken, this may cause eye injury.</p> <p><b>Skin Contact:</b> Wash the affected area under tepid running water using a mild soap. If appropriate procedures are not taken, this may cause sores on the skin. Get medical attention if irritation develops or persists.</p> <p><b>Inhalation:</b> Remove to fresh air immediately. Get medical treatment immediately.</p>

### 1.2.1 Intended Use of the System

The DCX V Power Supply and components are designed to be used as part of an ultrasonic welding system. These are designed for a wide variety of welding or processing applications.

### 1.2.2 Emissions

When being processed, certain plastic materials can emit toxic fumes, gases or other emissions that can be hazardous to the operator's health. Where such materials are processed, proper ventilation of the workstation is required. Check your materials suppliers for recommended protection when processing their materials.

WARNING	Corrosive Material Hazard
	<p>Processing of many materials, such as PVC, can be hazardous to an operator's health and could cause corrosion/damage to the equipment. Use proper ventilation and take protective measures.</p>

### 1.2.3 Setting up the Workplace

Measures for setting up a workplace for safe operation of the ultrasonic welder are outlined in [Chapter 5: Installation and Setup](#).

### 1.2.4 Regulatory Compliance

This product meets electrical safety requirements and EMC (Electromagnetic Compliance) requirements for North America, Great Britain and the European Union.

## 1.3 How to Contact Branson

Branson is here to help you. We appreciate your business and are interested in helping you successfully use our products. To contact Branson for help, use the following telephone numbers, or contact the office nearest you.

### 1.3.1 Authorized Service Center (North America)

**Table 1.1** Authorized Service Center (North America)

Name	Address	Tel/Fax Number
Branson Ultrasonics Corp. Global Headquarters United States	120 Park Ridge Road Brookfield, CT 06804	Tel: 1-203-796-0400 Fax: 1-203-796-0593 <a href="mailto:info@bransonultrasonics.com">info@bransonultrasonics.com</a>

### 1.3.2 Authorized Service Centers (South America)

**Table 1.2** Authorized Service Centers (South America)

Name	Address	Tel/Fax Number
Intersonic Argentina	Av. Cramer 2361 1C Buenos Aires 1428	Tel: 011-54-11-4781-2327 Fax: 011-54-11-4782-2412
Branson do Brasil Brasil	Rua Goiatuba, 81 06465-300 – Barueri / SP	Tel: 55-11-4208-1652

### 1.3.3 Authorized Service Centers (Asia)

**Table 1.3** Authorized Service Centers (Asia)

Name	Address	Tel/Fax Number
Branson Ultrasonics (Shanghai) Co. Ltd. – China Headquarters China	758 East Rong Le Road, Songjiang Songjiang Industry Zone CN-Shanghai, 201613 PRC	Tel: 86-21-3781-0588 Fax: 86-21-5774-5100 <a href="mailto:c.service@emerson.com">c.service@emerson.com</a>
Branson Ultrasonics Co. Ltd. Beijing Office	Room 216, Flat B, 12 Hong Da North Road, Chuangxin Technological Mansion Beijing Department Area. Beijing 100176 PRC	Tel: 86-10-6787-7806 Fax: 86-10-6787-3378
Branson Ultrasonics Co. Ltd. Tianjin Office		Tel: 86-22-2732-5233 Fax: 86-22-2732-3581
Branson Ultrasonics Co. Ltd. Dongguan Office		Tel: 86-769-8541-0736 Fax: 86-769-8541-0735
Branson Ultrasonics Co. Ltd. Suzhou Office		Tel: 86-512-6295-3652 Fax: 86-512-6295-3651
Branson Ultrasonics Asia Pacific Co. Ltd. Hong Kong Office	Flat A, 5/F Pioneer Building 213 Wai Yip Street, Kwung Tong Kowloon, Hong Kong	Tel: 852-2790-3393 Fax: 852-2341-2716 <a href="mailto:info@emerson.com">info@emerson.com</a>
Branson Ultrasonics Div. of Emerson Electric Co. P. Ltd. "Ajanta House" India	8/35, Marol Co-Op Industrial Estate M.V. Road, Andheri (East) Mumbai 400 059, India	Tel: 91-22-2850-5570 Fax: 91-22-2850-8681
Branson Ultrasonics Japan Headquarters Division of Emerson Japan Ltd.	4-3-14 Okada, Atsugi-Shi Kanagawa 243-0021 Japan	Tel: 81-46-228-2881 Fax: 81-46-288-8892
Branson Korea Co., Ltd. Korea	#803, 8F Dongil Techno Town 823, Kwan Yang-2dong, Dong An-gu An Yang-si, Kyung Ki-do, 431-062 Korea	Tel: 82-1577-0631 Fax: 82-31-422-9572

**Table 1.3** Authorized Service Centers (Asia)

Name	Address	Tel/Fax Number
Branson Ultrasonics Div. of Emerson Elec (M) Sdn Bhd. Malaysia	No. 20, Jalan Rajawali 3, Puchong Jaya Industrial Park Batu 8, Jalang Puchong 47170 Puchong, Selangor Malaysia	Tel: 603-8076-8608 Fax: 603-8076-8302
Branson Ultrasonics Philippines	Emerson Building 104 Laguna Blvd. Laguna Technopark Inc. Sta. Rosa, Laguna, 4026 Philippines	Tel: 63-49-502-8860 Fax: 63-49-502-8860 Mobile: 63-917-5372072
Branson Ultrasonics Singapore	10 Pandan Crescent #03-06 UE Tech Park LL3 Singapore 128466	Tel: 65-6891-7600 Fax: 65-6873-7882
Branson Ultraschall Taiwan	Div. of Emerson Electric (Taiwan) Co. Ltd. 5F-3, No. 1, Wu-Chiuan First Road Wu-Ku Ind Zone, Hsin- Chuang City Taipei Hsien 24892, Taiwan	Tel: 886-2-2298-0828 Fax: 886-2-2298-9985
Emerson Limited Thailand	662/39-40 Rama 3 Road Bangpongpan, Yannawa Bangkok 10120, Thailand	Tel: 66-2-293-01217 Fax: 66-2-293-0129

### 1.3.4 Authorized Service Centers (Europe)

**Table 1.4** Authorized Service Centers (Europe)

Name	Address	Tel/Fax Number
Branson Ultraschall Czech Republic		Tel: 420-374-625-620 Fax: 420-374-625-617
Branson Ultrasons France	1 Rue des Pyrenees Silic 404 94573 Rungis Cedex France	Tel: 33-1-4180-2550 Fax: 33-1-4687-8729
Branson Ultraschall European Headquarters Germany	Niederlassung der EMERSON Technologies GmbH & Co. OHG Waldstraße 53-55 63128 Dietzenbach, Germany	Tel: 49 (0)6074/497-0 Tel: 49 (0)6074/497-784 Fax: 49 (0)6074/497-199 <a href="mailto:info@branson.de">info@branson.de</a>
Branson Ultrasuoni, S.r.l. Italy	Via Dei Lavoratori, 25 20092 Cinisello Balsamo Milano, Italy	Tel: 39-02-660-8171 Fax: 39-02-660-10480
Branson Ultrasonics B.V. Netherlands	P.O. Box 9, 3760 Soest The Netherlands	Tel: 31-35-60-98101
Branson Ultrasonidos S.A.E. Portugal	Rua General Orlando Barbosa 74, RC-NP 4490-640 Póvoa de Varzim Portugal	Tel: 351-936-059-080 Mobil: 351-252-101-754
Emerson a.s., division Branson Slovakia	Piestandska 1202/44 91528 Nove Mesto Nad Vahom Slovak Republic	Tel: 421-32-7700-501 Fax: 421-32-7700-470
Branson Ultrasonidos S.A.E. Spain	Edificio Emerson C/Can Pi, 15 1ª Planta (Antigua Carretera del Prat) Polígono Industrial Gran Vía Sur 08908 HOSPITALET DE LLOBREGAT (BARCELONA) Spain	Tel: 34-93-586-0500 Fax: 34-93-588-2258

**Table 1.4** Authorized Service Centers (Europe)

Name	Address	Tel/Fax Number
Branson Ultrasonics S.A. Switzerland	Sonifers: Case Postale 1031 Brasonics: Chemin du Faubourg-de-Cruseilles 9 CH 1227, Carouge, Switzerland	Tel: 41-22-304-8340 Tel: 41-58-611-1222 Fax: 41-22-304-8359
Branson Ultrasonics United Kingdom	158 Edinburgh Avenue Slough, Berkshire England SL1 4UE	Tel: 44-1753-756675 Fax: 44-1753-551270
Branson Ultraschall Rusia	Torfyanaya road, 7F 197374, Saint-Petersburg Russia	Tel: 7-812-449-35-24 Mobile: 7-962-693-77-12

---

## **Chapter 2: Introduction**

---

<b>2.1</b>	<b>Models Covered . . . . .</b>	<b>14</b>
<b>2.2</b>	<b>Compatibility with other Branson Products . . . . .</b>	<b>17</b>
<b>2.3</b>	<b>Features . . . . .</b>	<b>18</b>
<b>2.4</b>	<b>Controls and Indicators. . . . .</b>	<b>20</b>
<b>2.5</b>	<b>Welding Systems. . . . .</b>	<b>22</b>
<b>2.6</b>	<b>Glossary. . . . .</b>	<b>23</b>

## 2.1 Models Covered

This manual covers all models of the DCX V Power Supply.

**Table 2.1** Models Covered In This Manual

Frequency	Power	Model	EDP
20 kHz	1250 W	Horizontal	101-132-1808
		Vertical	101-132-1815
	2500 W	Horizontal	101-132-1809
		Vertical	101-132-1816
	4000 W	Horizontal	101-132-1810
		Vertical	101-132-1817
30 kHz	750 W	Horizontal	101-132-1811
		Vertical	101-132-1818
	1500 W	Horizontal	101-132-1812
		Vertical	101-132-1819
40 kHz	400 W	Horizontal	101-132-1807
		Vertical	101-132-1814
	800 W	Horizontal	101-132-1813
		Vertical	101-132-1820

## 2.1.1 Overview of these Models

**Figure 2.1** The DCX V Power Supply (Horizontal)



**Figure 2.2** The DCX V Power Supply (Vertical)



The DCX V Power Supply generates ultrasonic energy through an ultrasonic converter for welding plastics. Several models are available, depending on the desired frequency (for example, 20 kHz), the desired power range (for example, 2.5 kW), and the intended mounting arrangement (horizontal or vertical). The power supply also contains a microprocessor-based controller module that provides for control and monitoring of welding operations.

The power supply provides the following features:

- **End of Weld Store:** Allows the power supply to track and store the frequency of the last weld
- **Timed Seek:** Tracks and starts the stack on the correct frequency. It does this by running the horn at a low-level amplitude (10%) to find and lock on to the stack operating frequency. Seeks are timed from the moment sonics was last activated
- **Line Regulation:** Maintains converter amplitude by regulating for variances in the line voltages
- **Load Regulation:** Maintains converter amplitude over the full range of rated power
- **System Protection:** Protects the power supply by providing six levels of protection
  - Voltage
  - Current
  - Phase
  - Temperature
  - Power
  - Frequency
- **Web Page Interface:** Provides access, via Ethernet connection, to power supply information, diagnostics, and configuration web pages
- **Frequency Offset:** Provides for applying an external frequency offset to the operating frequency
- **Amplitude Control:** Provides complete control of amplitude throughout the weld cycle: programmable starting ramp, and digital setting of weld amplitude

## 2.1.2 Power Supply Manual Set

The following documentation is available in electronic format for the DCX V Power Supply:

- DCX V Power Supply Instruction Manual (4000840)
- DCX V Power Supply Quick Start Guide (4000842)
- DCX V Power Supply Web Page Interface Instruction Manual (4000843)

## 2.2 Compatibility with other Branson Products

**Table 2.2** Power Supply Compatibility with Branson Converters

DCX V Model	Converter
20 kHz / 1250 W 20 kHz / 2500 W 20 kHz / 4000 W	CR-20S
	CR-20C
	CH-20S (932 AH SPL)
	CH-20C
	CS-20S
	CS-20C
30 kHz / 750 W 30 kHz / 1500 W	CR-30S
	CR-30C
	CH-30S
	CH-30C
	CS-30S
	CS-30C
40 kHz / 400 W 40 kHz / 800 W	CR-40S (4TH)
	CR-40C
	4TP

## 2.3 Features

### 2.3.1 The Welding System

The welding system consists of a DCX V Power Supply and a converter-booster-horn stack. The system can perform ultrasonic welding, inserting, staking, spot welding, swaging, degating, and continuous ultrasonic operations. It is designed for automated, semi-automated and/or manual production operations.

### 2.3.2 The Power Supply

The DCX V Power Supply consists of an ultrasonic power supply assembly with a system controller and user interfaces. The ultrasonic power supply assembly converts conventional 50/60 Hz line current to 20 kHz, 30 kHz or 40 kHz electrical energy. The system controller controls the welding system.

Listed below are the control features of the DCX V Power Supply ultrasonic welding system.

- **Autotuning:** Branson power supply tuning ensures that the system is running at peak efficiency
- **Digital Amplitude Setting:** This feature allows you to set the exact amplitude necessary for your application, allowing increased range and setting repeatability over analog systems
- **Frequency Offset:** This process feature allows a user to set a frequency value, for certain specific applications, where the force imparted on the fixture or anvil causes a frequency shift in the stack's operation. You should only use this feature when advised to do so by Branson
- **Horn Signature:** Using the DCX V Power Supply Web Page Interface, you may scan your ultrasonic stack to view its operating frequency on your computer, using digital readouts and bar graphs to give you the best picture of the stack's operation
- **Login ID Numbers:** Allows for keeping track of user access to the DCX V Power Supply Web Page Interface
- **Ramp Starting:** The starting of the DCX V Power Supply and horn is done at a rate that helps reduce electrical and mechanical stress on the system. The horn start rate may be adjusted for some tough-to-start applications
- **Seek:** Ensures operation at resonance; minimizes tuning errors; and operates the stack at low amplitude (approximately 10%), then provides a means of sensing and storing the resonant operating frequency value
- **Start-up Diagnostics:** At start-up, the controls test the major internal components
- **Timed Seek:** When enabled, will do a Seek once every minute to update horn resonant frequency to memory. This is especially useful when the welding process affects the actual temperature of the horn, causing a resonant frequency shift
- **True Wattmeter:** The controls on the power supply include a true wattmeter for accurate measurement of power and energy
- **Web Page Interface:** Provides access, via Ethernet connection, to power supply information, diagnostics, and configuration web pages

### 2.3.3 The Actuator

The DCX V Power Supply does not provide actuator control functions, and does not interface with actuator signals.

### 2.3.4 Converter/Booster/Horn Assembly

#### The Converter

The ultrasonic electrical energy from the power supply is applied to the converter (sometimes called the transducer). This transforms the high frequency electrical oscillations into mechanical vibrations at the same frequency as the electrical oscillations. The heart of the converter is piezoelectric ceramic elements. When subjected to an alternating voltage, these elements alternately expand and contract, resulting in better than 90% conversion of electrical to mechanical energy.

#### The Booster

Success in ultrasonic assembly depends on the right amplitude of movement at the horn face. Amplitude is a function of horn shape, which is largely determined by the size and form of the parts to be assembled. The booster can be used as a mechanical transformer to increase or decrease the amplitude of vibrations applied to the parts through the horn.

The booster is a resonant half-wave section of aluminum or titanium. It is mounted between the converter and the horn, as part of the ultrasonic stack. It also provides a clamping point for rigid stack mounting.

Boosters are designed to resonate at the same frequency as the converter with which they are used. Boosters are usually mounted at a nodal (minimum vibration) point of axial motion. This minimizes the loss of energy and prevents vibration from being transmitted to the stack supporting structure.

#### The Horn

The horn is selected or designed for a specific application. Each horn is tuned typically as a half-wave section that applies the necessary force and vibration uniformly to the parts to be assembled. It transfers ultrasonic vibrations from the converter to the workpiece. The horn is mounted to the booster as part of the ultrasonic stack.

Depending on their profile, horns are referred to as stepped, conical, exponential, bar, or catenoidal. The shape of the horn determines the amplitude at the face of the horn. Depending on the application, horns can be made from titanium alloys, aluminum, or steel. Titanium alloys are the best materials for horn fabrication due to their high level of strength and low loss. Aluminum horns are usually chrome- or nickel-plated or hard-coated to reduce wear. Steel horns are for low amplitude requiring hardness, such as ultrasonic insertion applications.

## 2.4 Controls and Indicators

### 2.4.1 DCX V Power Supply Front Panel

**Figure 2.3** DCX V Power Supply Front Panel Indicators

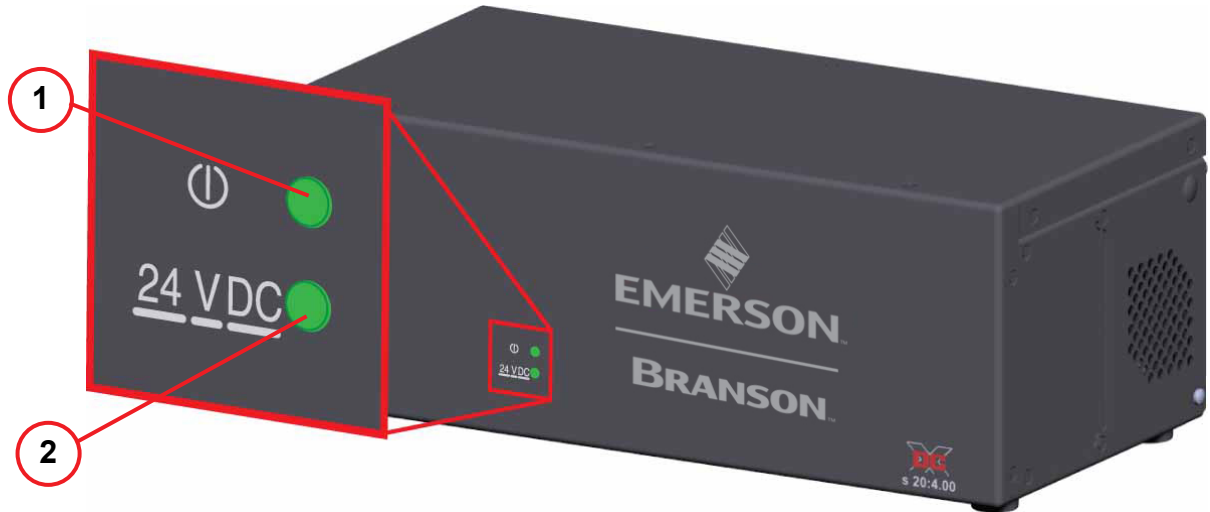

**Table 2.3** DCX V Power Supply Front Panel Indicators

Item	Name	Function
1	Power-On Indicator	Lights when the power supply is connected to main power and the power switch is on.
2	24 V Indicator	Lights when 24 V are supplied to the DCX V Power Supply.

## 2.4.2 DCX V Power Supply Connections

**Figure 2.4** DCX V Power Supply Back Panel (Horizontal)



**Figure 2.5** DCX V Power Supply Bottom Panel (Vertical)

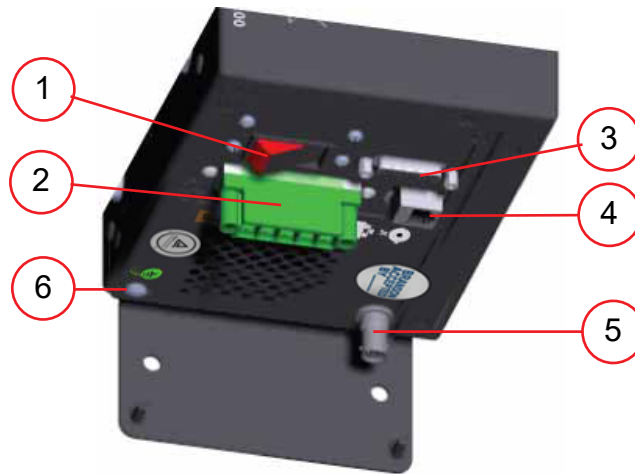

**Table 2.4** Connections to the DCX V Power Supply

Item	Name	Function
1	Circuit Breaker / Power Switch	Turns the AC main power on or off.
2	Line Input Connector	Detachable connector block for connecting the input power. For wiring details refer to <a href="#">Chapter 5: Installation and Setup</a> .
3	User I/O Connector	Provides the necessary input/output signals to interface with user automation or control interfaces. For detailed information on interfacing with the DCX V Power Supply refer to <a href="#">Chapter 5: Installation and Setup</a> .
4	RF Connector	SHV connector for RF cable, which provides ultrasonic energy to the converter.
5	Ground Screw	Ground screw to serve as a redundant safety measure.

## 2.5 Welding Systems

### 2.5.1 Principle of Operation

Thermoplastic parts are welded ultrasonically by applying high frequency vibrations to the parts being assembled. The vibrations, through surface and intermolecular friction, produce a sharp rise in temperature at the welding interface.

When the temperature is high enough to melt the plastic, there is a flow of material between the parts. When the vibrations stop, the material solidifies under pressure and a weld results.

### 2.5.2 Weld System Applications

DCX V Power Supply weld systems can be used for the following applications:

- Ultrasonic welding
- Cutting and sealing thermoplastic fabric and film
- Staking, spot welding, swaging, and degating thermoplastic parts
- Other ultrasonic processing applications

DCX V Power Supply weld systems typically consist of a power supply operated with a fixed converter-booster-horn stack.

## 2.6 Glossary

The following terminology may be encountered when using or operating a DCX V Power Supply ultrasonic welding system:

**Actuator:** The unit which houses the converter/booster/horn stack assembly in a rigid mounting, allowing the stack to move up and down, either mechanically or pneumatically, applying force to the part at a user-adjustable force and velocity.

**Alarm:** Visual indication of error.

**Amplitude Control:** The ability to set amplitude digitally or by an external control.

**Amplitude:** The peak-to-peak movement at the horn face. Always expressed as a percentage of the maximum.

**Booster:** A one-half-wavelength-long resonant metal section mounted between the converter and horn, sometimes having a change in cross-sectional area between the input and output surfaces. The booster mechanically alters the amplitude of vibrations received from the converter, and imparts the new amplitude to the horn.

**Clamping Force:** The pounds or kilograms exerted by the horn onto the workpiece.

**Converter:** The device that converts electrical energy into mechanical vibrations at a high frequency (an ultrasonic rate).

**Counters:** A record of the number of cycles, general alarms, power-on hours, etc, recorded in the power supply.

**Degating:** Removing a molded part from its runner system.

**Energy Director:** A triangular-shaped projection of plastic material which concentrates the ultrasonic energy at the joint interface of a plastic part.

**External Amplitude Control:** Enables you to access real-time amplitude control directly via the user I/O connector.

**External Frequency Control:** Enables you to access real-time frequency offset control directly via the user I/O connector.

**Fixture:** A device for holding a part in position for assembly.

**Flash:** Material displaced from the joint area.

**Forming:** Reshaping a section of thermoplastic.

**Fretting Corrosion:** A black surface condition, that results from friction between metal parts, that appears on the converter-booster-horn stack mating surfaces.

**Frequency:** The operating frequency of the ultrasonic stack. The frequency stored is measured at the end of the ultrasonic portion of the cycle (when ultrasonics are terminated).

**Frequency Offset:** An offset factor applied to the ultrasonic frequency stored in the power supply.

**Gain:** The ratio of output to input amplitude of a horn or booster.

**Horn:** A bar or metal section, usually one half-wavelength-long which transfers vibratory energy to the workpiece.

**Horn Amplitude:** The peak-to-peak displacement of a horn at its work face.

**Horn Scan:** A scan to enhance selection of operating frequency and control parameters.

**Insertion:** The process of embedding a metal component in plastic.

**Interface:** 1. The contact surface of two mating parts. 2. The connection between two pieces of equipment.

**Joint:** The weld surfaces.

**Parameter:** A unique factor or element which affects the welding operation in a particular mode.

**Parameter Range:** Valid range of parameters accepted for a particular setup.

**Power Supply:** The electronic instrument in an ultrasonic assembly system which changes conventional 50/60 Hz electrical power into high frequency electrical power at 20 kHz, 30 kHz or 40 kHz.

**Seek:** The activation of ultrasonics at a low-level (10%) amplitude, for the purpose of finding the resonant frequency of the stack.

**Staking:** The process of melting and reforming a plastic stud to mechanically lock a dissimilar material in place.

**Swaging:** The process of capturing another component of an assembly by melting and reforming a ridge of plastic.

**Thermoplastic:** A polymer which undergoes a reversible change of state when subjected to heat.

**Thermoset:** A polymer which undergoes an irreversible change when subjected to heat.

**Ultrasonic Power:** Presence of ultrasonic power at the horn face.

**Ultrasonic Welding:** The use of ultrasonic vibrations to generate heat and subsequently melt the mating surfaces of two thermoplastic parts. When ultrasonic vibrations stop, the molten material resolidifies, and a weld occurs.

**User ID:** A unique number used to keep track of user access to the web page interface.

**Weld System:** A combination of components required to perform an ultrasonic operation. Usually consists of a power supply, converter, booster, and horn, with either an actuator or a handheld device, or in a fixed, mounted location.

---

## **Chapter 3: Delivery and Handling**

---

<b>3.1</b>	<b>Shipping and Handling</b> .....	<b>26</b>
<b>3.2</b>	<b>Receiving</b> .....	<b>27</b>
<b>3.3</b>	<b>Unpacking the Power Supply</b> .....	<b>28</b>
<b>3.4</b>	<b>Take Inventory of Small Parts</b> .....	<b>29</b>
<b>3.5</b>	<b>Returning Equipment</b> .....	<b>30</b>

## 3.1 Shipping and Handling

CAUTION	Heavy Object
	<p>The power supply may be heavy. Handling, unpacking, and installation may require the assistance of a colleague or the use of lifting platforms or hoists.</p>

### 3.1.1 Environmental Specifications

The DCX V Power Supply is an electronic unit that converts line voltage to ultrasonic energy and responds to user input for regulating the weld process. Its internal components are sensitive to static discharge, and many of its components can be harmed if the unit is dropped, shipped under improper conditions, or otherwise mishandled.

The following environmental guidelines should be respected in the shipping of the power supply.

**Table 3.1** Shipping Specifications

Environmental Condition	Acceptable Range
Storage / Shipping Temperature	-25° C / -13° F to +55° C / +131° F (+70° C / +158° F for 24 hours)
Shock / Vibration (transit)	45 g shock / 0.5 g and (3 to 100 Hz) vibration per ASTM 3332-88 and 3580-90
Drop Test	ISTA Procedure 1 & 2A (while packaged)
Humidity	Maximum 95%, non-condensing

## 3.2 Receiving

The DCX V Power Supply is a sensitive electronic device. Many of its components can be harmed if the unit is dropped or otherwise mishandled.

### Scope of Delivery

Branson equipment is carefully checked and packed before dispatch. It is recommended, however, that you follow the procedure below upon receiving your DCX V Power Supply.

**Inspect the Power Supply when it is delivered, take the following steps.**

**Table 3.2** Inspect the Power Supply

Step	Action
1	Verify that all parts are complete according to the packing slip.
2	Check the packing and the unit for damage (visual inspection).
3	Report any damage claims to your carrier immediately.
4	Determine if any component has become loose during shipping and, if necessary, tighten screws.

NOTICE	
	<p>If the goods delivered have been damaged during shipping, please contact the forwarding agent immediately. Retain packing material (for possible inspection or for sending back the unit).</p>

## 3.3 Unpacking the Power Supply

NOTICE	
	<p>If there are any visible signs of damage to the shipping containers or the product, or you later discover hidden damage, NOTIFY YOUR CARRIER IMMEDIATELY. Save the packing material.</p>

The power supply is fully assembled. It is shipped in a sturdy cardboard box. Some additional items are shipped in the box with the power supply. Note orientation of packaging material in case return/repack is necessary. When unpacking the power supply, take the following steps.

**Table 3.3** Unpacking the Power Supply

Step	Action
1	Unpack the power supply as soon as it arrives. Save the packing material.
2	Verify you have all of the equipment ordered. Some components are packed inside other boxes.
3	Inspect the controls, indicators, and surface for signs of damage.
4	Remove the cover of the power supply to check if any components became loose during shipping.

## 3.4 Take Inventory of Small Parts

**Table 3.4** Small Parts included (=x) Power Supply Assemblies

Part or Kit	20 kHz	30 kHz	40 kHz
Mylar®* plastic film Washer Kit	X	X	
Silicone Grease			X
Spanners (2)	X	X	X

\* Mylar is a registered trademark of DuPont Teijin Films.

### 3.4.1 Cables

The RF cable connects the power supply to the converter. For automated systems you will also need a user I/O cable to monitor and control the power supply. Check your invoice for cable types and cable lengths.

**Table 3.5** DCX V Power Supply System Cables

P/N	Description
100-240-383	Cable, RF 8 ft (2.5 m)
100-240-384	Cable, RF 15 ft (4.5 m)
100-240-385	Cable, RF 25 ft (7.5 m)
100-240-387	Cable, RF right angle 8 ft (2.5 m)
100-240-388	Cable, RF right angle 15 ft (4.5 m)
100-240-389	Cable, RF right angle 25 ft (7.5 m)
100-240-392	Cable, User I/O 25 ft (7.5 m)
200-240-396	Cable Ethernet Cat 5e 7 ft (2.1 m)

## 3.5 Returning Equipment

If you are returning equipment to Branson Ultrasonic Corporation, please call your Customer Service Representative to receive approval to return the goods. Refer to [1.3 How to Contact Branson](#).

---

## **Chapter 4: Technical Specifications**

---

<b>4.1</b>	<b>Technical Specifications</b> .....	<b>32</b>
<b>4.2</b>	<b>Physical Description</b> .....	<b>35</b>
<b>4.3</b>	<b>EU Declaration of Conformity</b> .....	<b>36</b>
<b>4.4</b>	<b>UK Declaration of Conformity</b> .....	<b>37</b>
<b>4.5</b>	<b>Standard Modules and Components</b> .....	<b>38</b>

## 4.1 Technical Specifications

NOTICE	
	All specifications are subject to change without notice.

### 4.1.1 Environmental Specifications

The DCX V Power Supply has the following environmental specifications:

**Table 4.1** Environmental Specifications

Environmental Condition	Acceptable Range
Ambient Operating Temperature	+41° F to +104° F (+5° C to +40° C)
Storage / Shipping Temperature	-13° F to +131° F (-25° C to +55° C)
Humidity	Maximum 95%, non-condensing
IP Rating	20 Protected against solid objects larger than 12.5 mm; no protection against water.
Altitude	Up to 6560 ft (2000 m)
Pollution degree	2 Only non-conductive pollution occurs; temporary conductivity caused by condensation may be expected.
Overvoltage category	II Equipment intended to be supplied from the building wiring.

### 4.1.2 Electrical Specifications

The following tables list input voltage and current requirements for the DCX V Power Supply.

**Table 4.2** Electrical Input Operating Voltages

Power Supply Rating	Input Operating Voltage
All Models	200 V to 230 V Nominal (180 V Min.* to 253 V Max.), 50 Hz or 60 Hz, Single Phase.
	24 VDC, 2.5 A

\* 200 V Min. for 4 kW units.

**Table 4.3** Input Current and Circuit Breaker Specifications

Model	Power	Current Rating
20 kHz	1250 W	7 A Max. @ 200 V / 15 A Breaker
	2500 W	14 A Max. @ 200 V / 25 A Breaker
	4000 W	25 A Max. @ 200 V / 25 A Breaker
30 kHz	750 W	5 A Max. @ 200 V / 10 A Breaker
	1500 W	10 A Max. @ 200 V / 15 A Breaker
40 kHz	400 W	3 A Max. @ 200 V / 10 A Breaker
	800 W	5 A Max. @ 200 V / 10 A Breaker

**Table 4.4** Continuous Duty Max. Power

Model	Power	Continuous Duty Max. Power
20 kHz	1250 W	800 W
	2500 W	1600 W
	4000 W	2000 W
30 kHz	750 W	300 W
	1500 W	800 W
40 kHz	400 W	300 W
	800 W	400 W

NOTICE	
	High duty cycles require additional cooling for the converter. For information on converter cooling refer to <a href="#">5.6 Converter Cooling</a> .

NOTICE	
	System average power must be limited to the specified continuous maximum. Higher peak power, up to the maximum acceptable power limit, with an on time of up to 10 seconds may be obtained if appropriate off time ensures that, on average, the Continuous Duty Maximum Power is not exceeded.

## 4.2 Physical Description

This section describes the physical dimensions of the DCX V Power Supply.

NOTICE	
	Dimensions are nominal.

**Table 4.5** Dimension and Weight of DCX V Power Supply

Size	Width	Height	Depth	Weight
Small (Benchtop)	14" 356 mm	5.5" 132 mm	7.4" 187 mm	16 lb 7.2 kg
Small (Vertical)	5.2" 132 mm	14" 356 mm		
Medium (Benchtop)	14" 356 mm	5.5" 132 mm	8.6" 219 mm	18 lb 8.2 kg
Medium (Vertical)	5.2" 132 mm	14" 356 mm		
Large (Benchtop)	14" 356 mm	5.5" 132 mm	10.6" 270 mm	22 lb 10 kg
Large (Vertical)	5.2" 132 mm	14" 356 mm		

For detailed dimensional information refer to [Chapter 5: Installation and Setup](#).

## 4.3 EU Declaration of Conformity

Figure 4.1 EU Declaration of Conformity

**EU DECLARATION OF CONFORMITY**

CE

We, the manufacturer

**BRANSON ULTRASONICS CORPORATION**  
120 Park Ridge Rd.  
Brookfield, CT 06804  
USA

represented in the community by

BRANSON ULTRASONICS, a.s.  
Piestanska 1202  
91501 Nove Mesto nad Vahom  
Slovak Republic

expressly declare under our sole responsibility that the following electrical equipment product:

Ultrasonic Assembly System consisting of an Ultrasonic Power Supply, model:

0.80 DCX(S, A, f-EIP, f-DP or f-pfn) 40 RACKMT 1.50 DCX(S, A, f-EIP, f-DP or f-pfn) 30 RACKMT 1.25 DCX(S, A, f-EIP, f-DP or f-pfn) 20 RACKMT 2.50 DCX(S, A, f-EIP, f-DP or f-pfn) 20 RACKMT 4.00 DCX(S, A, f-EIP, f-DP or f-pfn) 20 RACKMT DCX RM 222 STD DCX RM 240 STD DCX RM 222 B DCX RM 240 B DCX RM 480 STD DCX RM 315 STD DCX RM 211 STD DCX RM 480 B DCX RM 315 B DCX RM 211 B P/S 2.20 DCX STD 20 SIG	0.40DCX(s, v, a, f-dp, f-eip or f-pfn)40(VRT, V, H or HOR) 0.80DCX(s, v, a, f-dp, f-eip or f-pfn)40(VRT, V, H or HOR) 0.75DCX(s, v, a, f-dp, f-eip or f-pfn)30(VRT, V, H or HOR) 1.50DCX(s, v, a, f-dp, f-eip or f-pfn)30(VRT, V, H or HOR) 1.25DCX(s, v, a, f-dp, f-eip or f-pfn)20(VRT, V, H or HOR) 2.50DCX(S+, s, v, a, f-dp, f-eip or f-pfn)20(VRT, V, H or HOR) 4.00DCX(S+, s, v, a, f-dp, f-eip or f-pfn)20(VRT, V, H or HOR) 4.00DCXs20HD -V P/S 0.8 DCX S HD 40 VRT 1.50 DCX-S HD 30 (HOR or VRT) 1.50 DCX-S HD 30 VRT 4.00DCXs20HD -H P/S 0.8 DCX S HD 40 HOR P/S 4.0KW 20KHZ DCX S LIM RES 1.6DCX(a, f-dp, f-eip or f-pfn)40(B2H or B2V)
---	---

used with converter model: CR-20S, CR-20C, CH-20C, CS-20S, CS-20C, CR-30, CR-30C, CH-30, CH-30C, CS-30S, CS-30C, CR-40C, 4TH, 4TP or 932, and associated cables.

in the state in which it was placed on the market, fulfills all the relevant provisions and their amendments of:

Low Voltage Directive **2014/35/EU**  
EMC Directive **2014/30/EU**  
RoHS Directive **2011/65/EU**

The object of this declaration is in conformity with relevant Union harmonization legislation. The electrical equipment product, to which this declaration relates, is in conformity with the following standards:

EN 61010-1:2010+A1:2019  
EN 55011:2016/A11:2020  
EN 61000-6-2:2005/AC:2005

Brookfield, CT, USA

*Luis Benavides*

Luis Benavides (Feb 17, 2026 14:02:32 CST)  
Director of Engineering, Systems / Product Safety Officer

## 4.4 UK Declaration of Conformity

Figure 4.2 UK Declaration of Conformity



### UK DECLARATION OF CONFORMITY

We, the manufacturer

**BRANSON ULTRASONICS CORPORATION**

120 Park Ridge Rd.  
Brookfield, CT 06804  
USA

expressly declare under our sole responsibility that the following electrical equipment product:

Ultrasonic Assembly System consisting of an Ultrasonic Power Supply, model:

0.80 DCX(S, A, f-EIP, f-DP or f-pfn) 40 RACKMT	0.40DCX(s, v, a, f-dp, f-eip or f-pfn)40(VRT, V, H or HOR)
1.50 DCX(S, A, f-EIP, f-DP or f-pfn) 30 RACKMT	0.80DCX(s, v, a, f-dp, f-eip or f-pfn)40(VRT, V, H or HOR)
1.25 DCX(S, A, f-EIP, f-DP or f-pfn) 20 RACKMT	0.75DCX(s, v, a, f-dp, f-eip or f-pfn)30(VRT, V, H or HOR)
2.50 DCX(S, A, f-EIP, f-DP or f-pfn) 20 RACKMT	1.50DCX(s, v, a, f-dp, f-eip or f-pfn)30(VRT, V, H or HOR)
4.00 DCX(S, A, f-EIP, f-DP or f-pfn) 20 RACKMT	1.25DCX(s, v, a, f-dp, f-eip or f-pfn)20(VRT, V, H or HOR)
DCX RM 222 STD	2.50DCX(S+, s, v, a, f-dp, f-eip or f-pfn)20(VRT, V, H or HOR)
DCX RM 240 STD	4.00DCX(S+, s, v, a, f-dp, f-eip or f-pfn)20(VRT, V, H or HOR)
DCX RM 222 B	4.00DCXs20HD -V
DCX RM 240 B	P/S 0.8 DCX S HD 40 VRT
DCX RM 480 STD	1.50 DCX-S HD 30 (HOR or VRT)
DCX RM 315 STD	1.50 DCX-S HD 30 VRT
DCX RM 211 STD	4.00DCXs20HD -H
DCX RM 480 B	P/S 0.8 DCX S HD 40 HOR
DCX RM 315 B	P/S 4.0KW 20KHZ DCX S LIM RES
DCX RM 211 B	1.6DCX(a, f-dp, f-eip or f-pfn)40(B2H or B2V)
P/S 2.20 DCX STD 20 SIG	

used with converter model: CR-20S, CR-20C, CH-20C, CS-20S, CS-20C, CR-30, CR-30C, CH-30, CH-30C, CS-30S, CS-30C, CR-40C, 4TH, 4TP or 932, and associated cables.

in the state in which it was placed on the market, fulfills all the relevant provisions and their amendments of:

Electrical Equipment (Safety) Regulations **2016**  
Electromagnetic Compatibility Regulations **2016**  
Restriction of the Use of Certain Hazardous Substances in Electrical and Electronic Equipment Regulations **2012**.

The electrical equipment product, to which this declaration relates, is in conformity with the following designated standards:

EN 61010-1:2010+A1:2019  
EN 55011:2016/A11:2020  
EN 61000-6-2:2005/AC:2005

Brookfield, CT, USA

*Luis Benavides*

Luis Benavides (Feb 17, 2026 14:02:48 CST)

Director of Engineering, Systems / Product Safety Officer

## 4.5 Standard Modules and Components

The following sections describe the DCX V Power Supply internal circuits.

### 4.5.1 System Block Diagram

The block diagram for the DCX V Power Supply is shown below.

**Figure 4.3** System Block Diagram

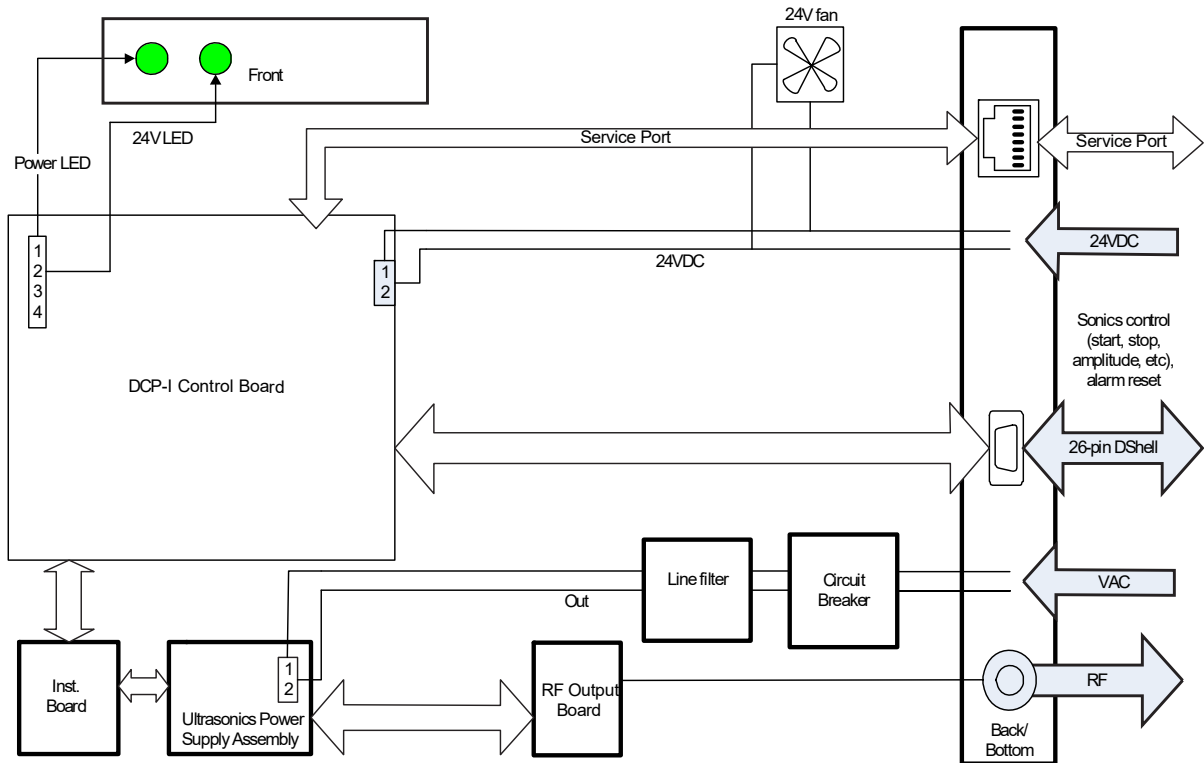

### 4.5.2 Circuit Descriptions

The DCX V Power Supply contains the following sub-assemblies:

- DCP-I Control Board
- Ultrasonics Power Supply Assembly
- Line Filter

## DCP-I Control Board

The DCP-I Control Board controls the following functions of the power supply:

- Responding to start and stop signals
- Responding to alarm and reset signals
- Controlling and monitoring ultrasonics
- Generating alarms
- Controlling communications
- Storing operating frequency of last weld (frequency memory) and using the stored frequency as a starting point for the next weld
- Checking and updating frequency memory on start-up
- Providing starting ramp times (Start)
- Provide a standard interface for automation (26-pin HD D-Sub Connector)

## Ultrasonic Power Supply Assembly

The ultrasonic power supply assembly generates ultrasonic energy at the resonant frequency of your converter-booster-horn stack. The ultrasonic power supply assembly contains three main circuits.

- **320 VDC Power Supply:** converts AC line voltage to +320 VDC for the output power devices
- **Output Circuit:** Matches the impedance of the output power device to the converter-booster-horn stack; and provides feedback to the control circuit
- **Interface Circuits:** perform the following functions:
  - Provide drive signal to output power device
  - Determine true percentage of ultrasonic power used over a range of amplitudes
  - Allow control of the resonant frequency
  - Control starting amplitude
  - Provide overload protection for the ultrasonic power assembly

## Line Filter

The line filter performs the function of providing RFI filtering for the line voltage input to the power supply. The filtering also blocks ultrasonic signals from entering the AC main line.



---

## **Chapter 5: Installation and Setup**

---

<b>5.1</b>	<b>About Installation . . . . .</b>	<b>42</b>
<b>5.2</b>	<b>Installation Requirements. . . . .</b>	<b>43</b>
<b>5.3</b>	<b>Installation Steps . . . . .</b>	<b>50</b>
<b>5.4</b>	<b>Power Supply Configuration . . . . .</b>	<b>66</b>
<b>5.5</b>	<b>Assembling the Acoustic Stack . . . . .</b>	<b>67</b>
<b>5.6</b>	<b>Converter Cooling . . . . .</b>	<b>72</b>
<b>5.7</b>	<b>Testing the Installation. . . . .</b>	<b>74</b>
<b>5.8</b>	<b>Still Need Help? . . . . .</b>	<b>75</b>

## 5.1 About Installation

This chapter is intended to help the installer with the basic installation and setup of your new DCX V Power Supply.

<b>CAUTION</b>	<b>Heavy Object</b>
	The power supply, and related components are heavy. Handling, unpacking, and installation may require the assistance of a colleague or the use of lifting platforms or hoists.

International safety-related labels are found on the power supply. Those that are of importance during installation of the system are identified in [Figure 1.1 Safety-related Labels found on the DCX V Power Supply \(Horizontal\)](#) and [Figure 1.2 Safety-related Labels found on the DCX V Power Supply \(Vertical\)](#).

## 5.2 Installation Requirements

This section covers the location requirements, mounting options, power supply dimensions, environmental requirements, and electrical requirements, to help you plan and execute your installation successfully.

### 5.2.1 Location

The DCX V Power Supply comes in two different models Horizontal (benchtop) and Vertical (which may be back mounted or side mounted).

The power supply should be accessible for parameter changes and settings, and it can be placed in a horizontal or vertical orientation (depending on your selected model). The power supply should be located in an area away from radiators or heating vents and positioned so it does not draw in dust, dirt or material via its cooling fan.

A cable clamp can be used to secure wires in place.

NOTICE	
	Cable clamp is not included with the unit.

Refer to the illustrations on the pages that follow for dimensional drawings of both models. All dimensions are approximate and may vary slightly:

[Figure 5.1 DCX V Power Supply Benchtop Dimensional Drawing.](#)

[Figure 5.2 DCX V Power Supply Vertical Mount Dimensional Drawing \(400 W, 750 W and 800 W\).](#)

[Figure 5.3 DCX V Power Supply Vertical Mount Dimensional Drawing \(1.25 kW and 1.5 kW\).](#)

[Figure 5.4 DCX V Power Supply Vertical Mount Dimensional Drawing \(2.5 kW and 4 kW\).](#)

**Figure 5.1** DCX V Power Supply Benchtop Dimensional Drawing

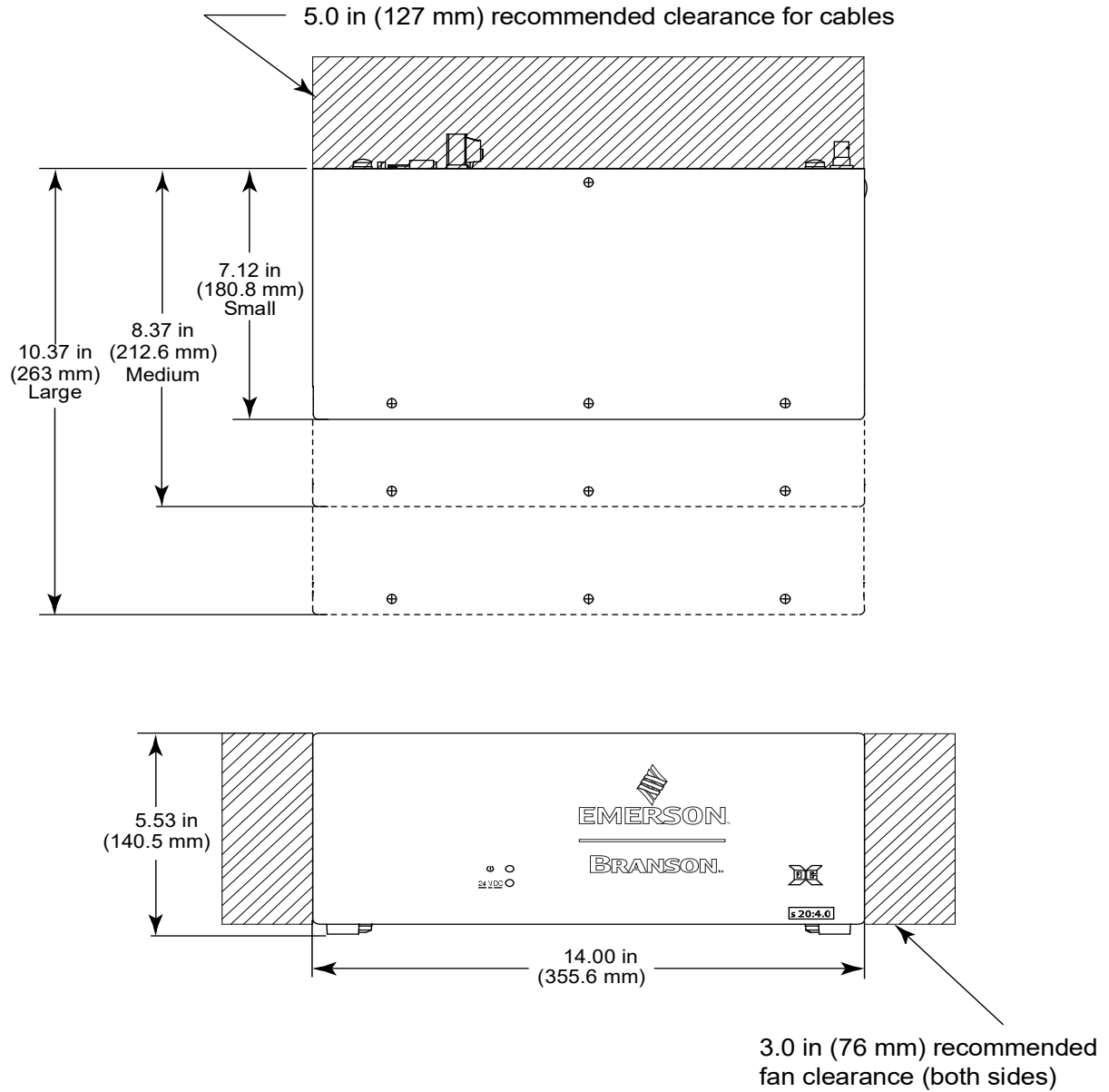

**Figure 5.2** DCX V Power Supply Vertical Mount Dimensional Drawing (400 W, 750 W and 800 W)

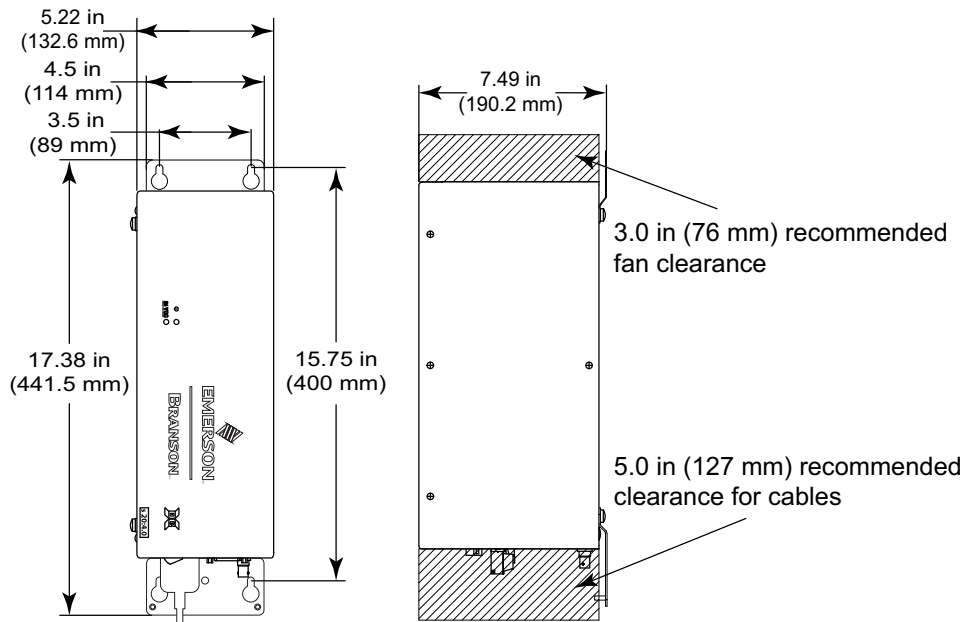

**Back-mounted**

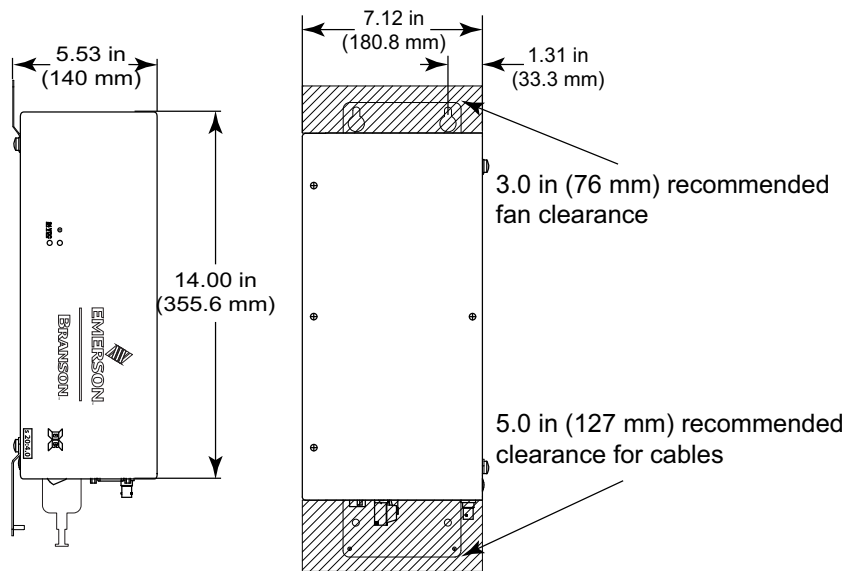

**Side-mounted**

**NOTICE**



Use the keyhole mounting bracket to mount the unit in the needed position. Use M6 (6mm) screws to mount the unit.

**Figure 5.3** DCX V Power Supply Vertical Mount Dimensional Drawing (1.25 kW and 1.5 kW)

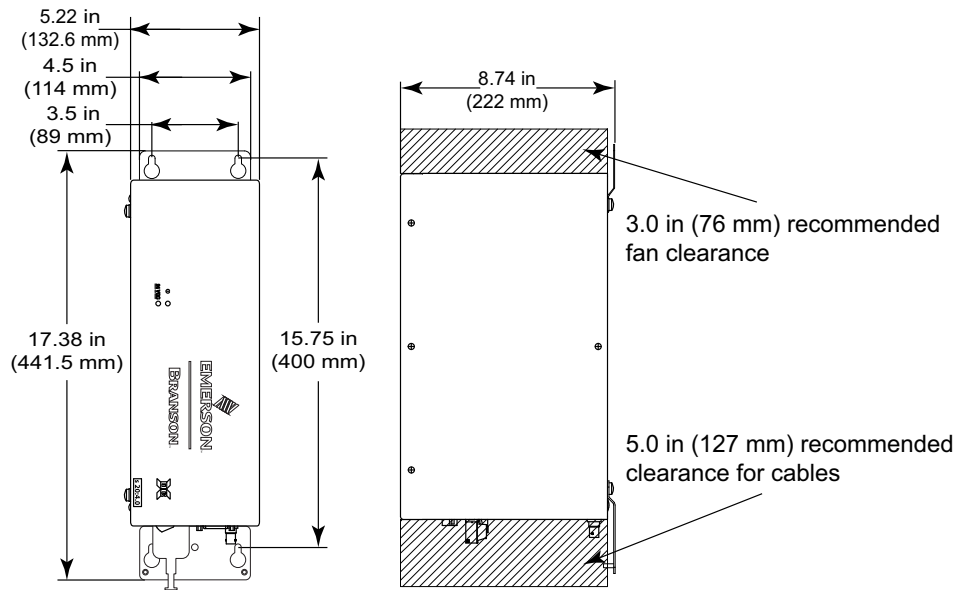

**Back-mounted**

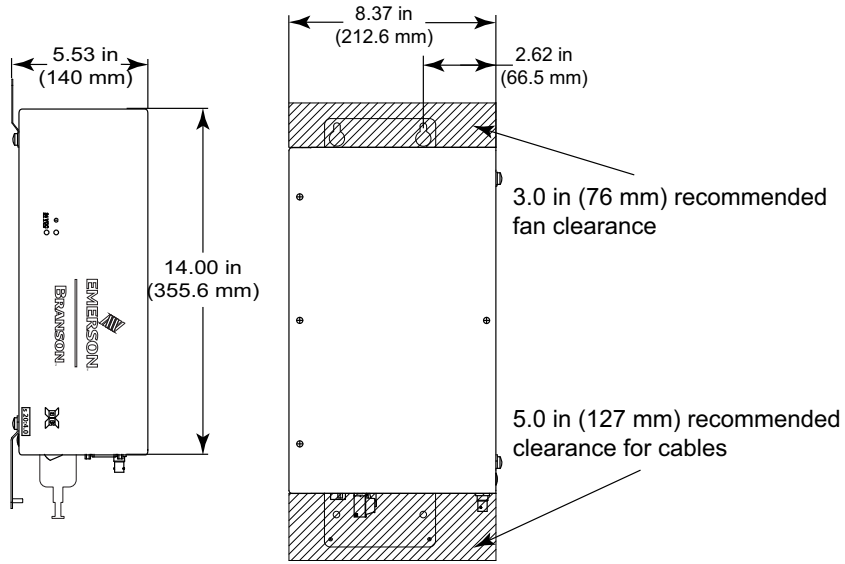

**Side-mounted**

<b>NOTICE</b>	
	<p>Use the keyhole mounting bracket to mount the unit in the needed position. Use M6 (6mm) screws to mount the unit.</p>

**Figure 5.4** DCX V Power Supply Vertical Mount Dimensional Drawing (2.5 kW and 4 kW)

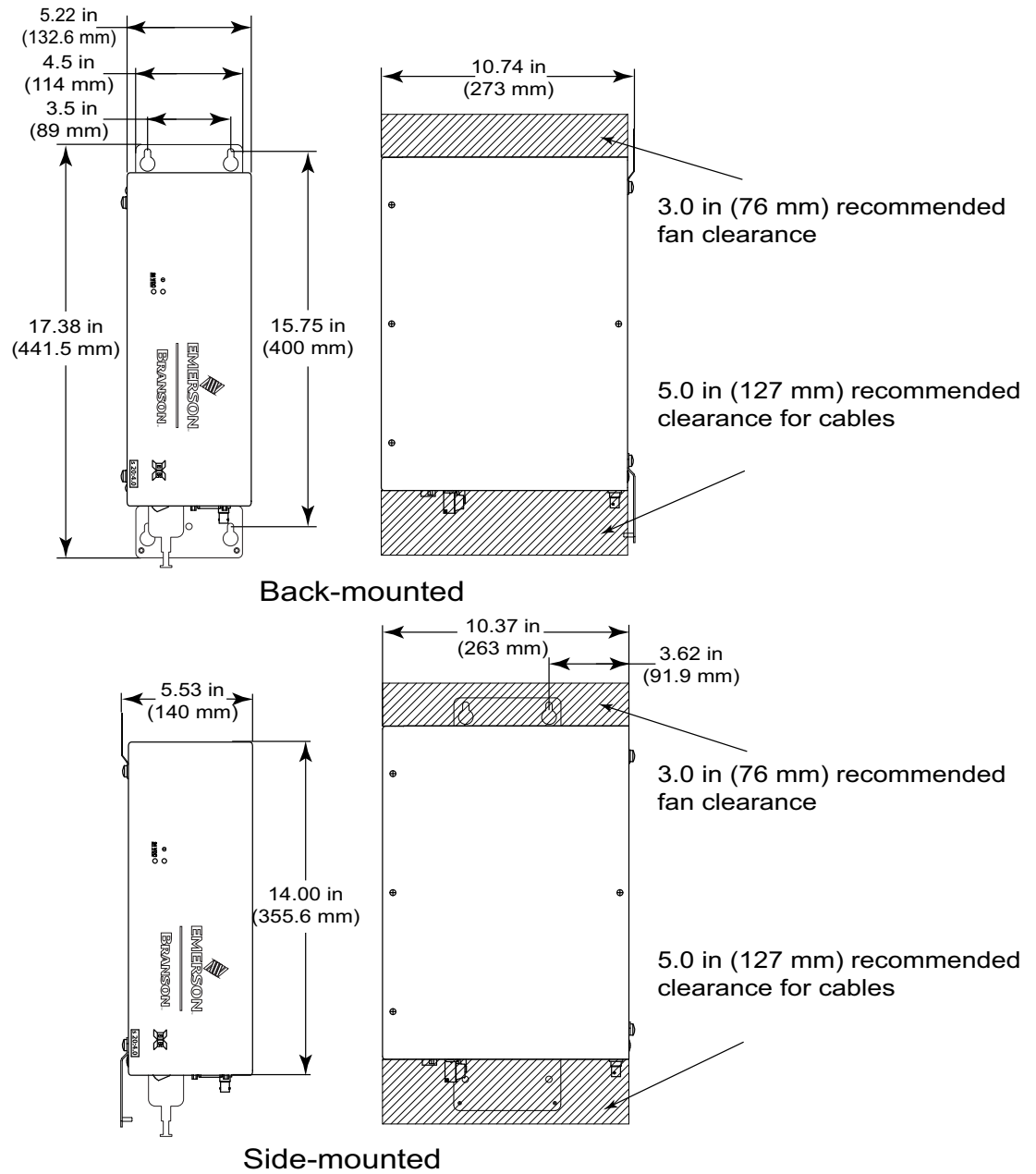

NOTICE	
	<p>Use the keyhole mounting bracket to mount the unit in the needed position. Use M6 (6mm) screws to mount the unit.</p>

## 5.2.2 Environmental Requirements

Verify the DCX V Power Supply is operated in an environment that meets the temperature and humidity requirements indicated in [Table 5.1 Environmental Requirements](#).

**Table 5.1** Environmental Requirements

Environmental Condition	Acceptable Range
Ambient Operating Temperature	+41° F to +104° F (+5° C to +40° C)
Humidity	Maximum 95%, non-condensing
Altitude	Up to 6560 ft (2000 m)
IP Rating	20 Protected against solid objects larger than 12.5 mm; no protection against water.
Pollution degree	2 Only non-conductive pollution occurs; temporary conductivity caused by condensation may be expected.
Overvoltage category	II Equipment intended to be supplied from the building wiring.

## 5.2.3 Electrical Input Power Ratings

Connect the power supply to a single-phase, grounded, 3-wire, 50 Hz or 60 Hz 200 V to 230 V power source. [Table 5.2 Input Current and Circuit Breaker Specifications](#) lists the current and breaker ratings for the various models.

**Table 5.2** Input Current and Circuit Breaker Specifications

Model	Power	Current Rating
20 kHz	1250 W	7 A Max. @ 200 V / 15 A Breaker
	2500 W	14 A Max. @ 200 V / 25 A Breaker
	4000 W	25 A Max. @ 200 V / 25 A Breaker
30 kHz	750 W	5 A Max. @ 200 V / 10 A Breaker
	1500 W	10 A Max. @ 200 V / 15 A Breaker
40 kHz	400 W	3 A Max. @ 200 V / 10 A Breaker
	800 W	5 A Max. @ 200 V / 10 A Breaker

#### 5.2.4 Pneumatic Requirements

Your welding system may require a cooling air stream for the converters. In continuous operations, or applications with longer duty cycles, it may be necessary to cool the horn as well as the converter.

Typically 80 cubic feet (2.26 m<sup>3</sup>) per hour of clean, dry, compressed air are required to cool most welding operations.

To verify the 80 cubic feet (2.26 m<sup>3</sup>) per hour cooling air stream required for your welding system, refer to [5.6 Converter Cooling](#).

## 5.3 Installation Steps

WARNING	High Voltage Hazard
	<p>To prevent the possibility of an electrical shock:</p> <ul style="list-style-type: none"><li>• Ensure the power source is disconnected before beginning work on line connections</li><li>• Ensure the power switch on the back of the unit is in the OFF position before making any electrical connections</li><li>• Always plug the power supply into a grounded power source</li><li>• To prevent the possibility of an electrical shock, ground the power supply by securing an 8 gage grounded conductor to the ground screw located next to the air outlet</li><li>• Ensure power supply installation is performed by qualified personnel and in accordance with local standards and regulations</li></ul>

### Basic installation notes:

- To avoid problems associated with EMI, you should route high power lines (AC and Ultrasonic RF) away from low power lines (controls signals)
- You should consider future troubleshooting and repair when installing all wiring. All wiring should be either color coded or tagged with industrial wire tags
- The minimum cable bend radius is 5 times the cable outer diameter for RF cables
- The minimum cable bend radius is 10 times the cable outer diameter for user I/O & Ethernet cables
- Ground wires should not be shared with other equipment
- All inductive coils must be suppressed with appropriate devices, such as diodes or RC networks

### 5.3.1 Mount the Power Supply

The cable lengths are limited based on the operating frequency of the welding system. Performance and results can suffer if the RF cable is crushed, pinched, damaged or modified. Contact your Branson Representative if you have special cable requirements.

Do not place the power supply on the floor or in other locations that will allow dust, dirt or contaminants to be drawn into the power supply.

NOTICE	
	<p>Special fan filter kits are available for use in dusty environments. See <a href="#">Table 8.12 Other Items used with the DCX V Power Supply</a>.</p>

NOTICE	
	<p>Do not block exhaust and intake air circulation, which is needed to maintain a safe operating temperature.</p>

### 5.3.2 Horizontal (Benchtop) Mounting

The Horizontal DCX V Power Supply is designed to be placed on a workbench (rubber feet on bottom) within cable-length limits of the stack. It has one fan which draws cooling air from the left side to the right side, which must be free from obstruction. The controls on the front of the power supply should be accessible and readable for setup changes.

All electrical connections are made to the rear of the power supply, which should be positioned in your workspace with adequate clearance (approximately 3 in (76.2 mm) or more on either side, and 5 in (127 mm) to the rear) for cable access and ventilation. Do not place anything on top of the power supply case.

For a dimensional drawing of the Horizontal DCX V Power Supply, see [Figure 5.1 DCX V Power Supply Benchtop Dimensional Drawing](#).

### 5.3.3 Vertical Mounting

The Vertical DCX V Power Supply is designed to be mounted vertically (from the side or back) within cable-length limits of the stack. It has one fan which draws cooling air from the top to the bottom of the power supply, which must be free from obstruction. The controls on the front of the power supply should be accessible and readable for setup changes.

All electrical connections are made to the bottom of the power supply, which should be positioned with adequate clearance (approximately 3 in (76.2 mm) or more on the top, and 5 in (127 mm) to the bottom) for cable access and ventilation. Do not place anything on top of the power supply case.

For dimensional drawings of the Vertical DCX V Power Supply, see figures [Figure 5.2 DCX V Power Supply Vertical Mount Dimensional Drawing \(400 W, 750 W and 800 W\)](#), [Figure](#)

5.3 DCX V Power Supply Vertical Mount Dimensional Drawing (1.25 kW and 1.5 kW), and Figure 5.4 DCX V Power Supply Vertical Mount Dimensional Drawing (2.5 kW and 4 kW).

## 5.3.4 Electrical Connections

**Figure 5.5** DCX V Power Supply Connections (Horizontal Model)

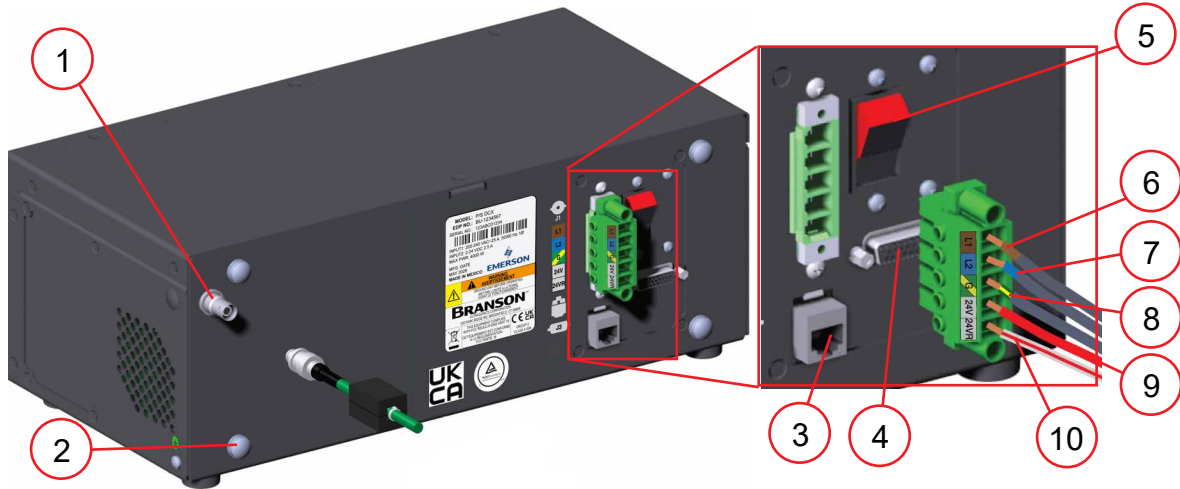

**Table 5.3** DCX V Power Supply Connections (Horizontal Model)

Item	Description
1	RF Connector
2	Ground Screw
3	Ethernet Port
4	User I/O Connector
5	Circuit Breaker (On/Off Switch)
6	L1
7	L2
8	GND
9	24 VDC
10	24 VDC Return

**Figure 5.6** DCX V Power Supply Connections (Vertical Model)

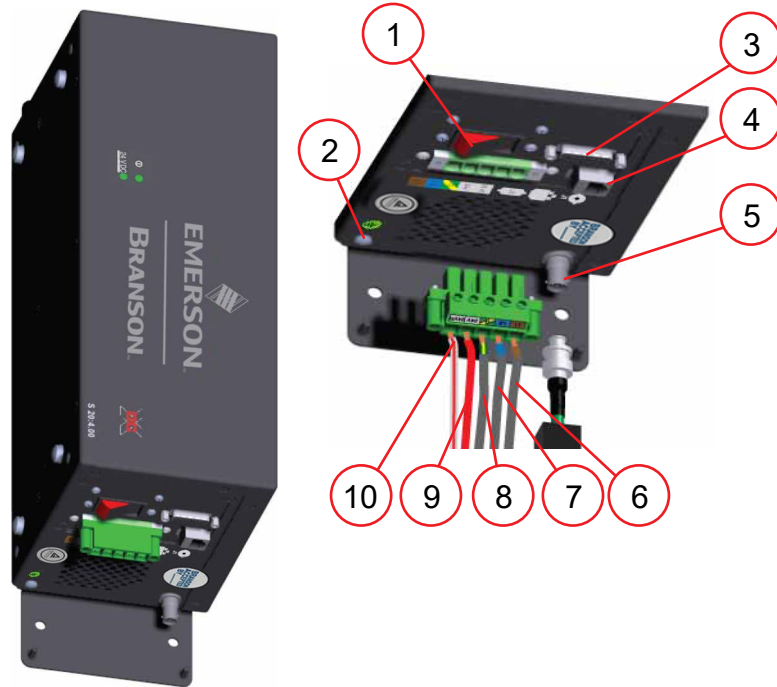

**Table 5.4** DCX V Power Supply Connections (Vertical Model)

Item	Description
1	Circuit Breaker (On/Off Switch)
2	Ground Screw
3	User I/O Connector
4	Ethernet Port
5	RF Connector
6	L1
7	L2
8	GND
9	24 VDC
10	24 VDC Return

**NOTICE**



Connector is shown rotated.

## 5.3.5 User I/O Connections

The user I/O is a standard interface for automation, provided on the power supply. It provides the ability to make your own interface for your automation, special control, or reporting needs. The interface cable has a 26-pin HD male D-Sub connector on one end, and wires on the other end. Pins are wired to ICEA standard color code (see [Figure 5.7 User I/O Cable Identification and Wire Color Diagram](#) and [Table 5.5 User I/O Cable Pin assignments](#)).

NOTICE	
	Ensure all unused wires are properly isolated. Failure to do so may result in a power supply malfunction.

Digital I/O functions can be configured to either active-high or active-low using the DCX V Power Supply Web Page Interface. [Table 5.6 Available Digital Input Functions](#) to [Table 5.9 Available Analog Output Functions](#) list the input and output functions available on the DCX V Power Supply. See [Table 5.10 Default User I/O Connector Pin Assignments](#) for the default user I/O pin assignments.

[Figure 5.8 Typical Digital I/O Wiring Examples](#) and [Figure 5.9 Typical Analog I/O Wiring Examples](#) show typical wiring examples.

For complete instructions detailing the web page interface consult the DCX V Power Supply Web Page Interface Instruction Manual (4000843).

**Figure 5.7** User I/O Cable Identification and Wire Color Diagram

User I/O Cable  
 Stripped Jacket one end,  
 HD-26 male connector other end  
 (cable length as ordered)

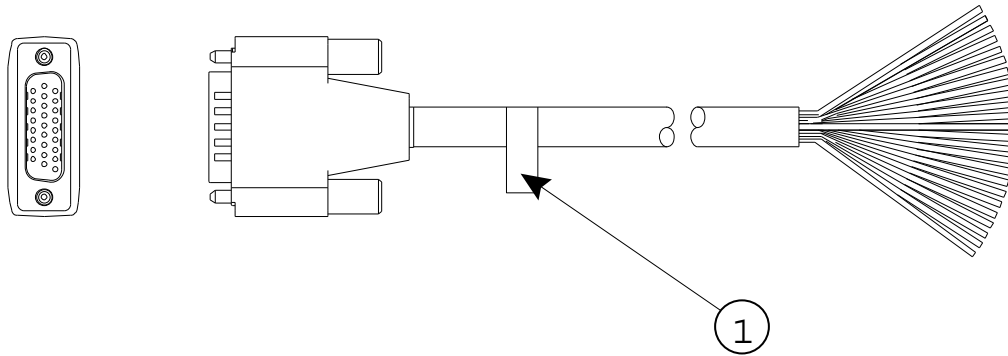

Wire Color Diagram  
 Two Colors = Insulator/Stripe  
 Three Colors = Insulator/Stripe/Dot

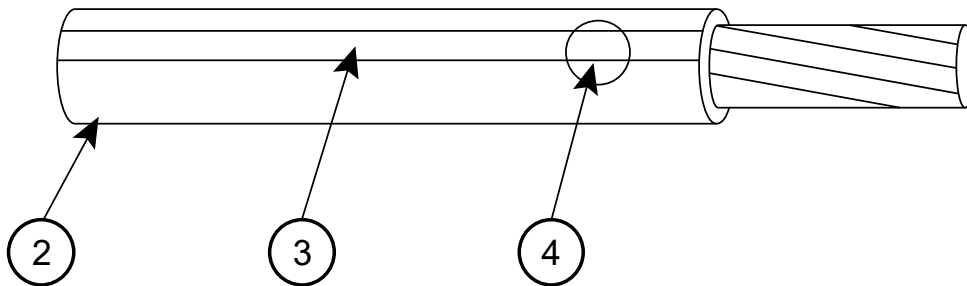

Item	Description
1	Part number
2	Insulation
3	Stripe
4	Dot

## 5.3.6 User I/O Cable Pin Assignments

**Table 5.5** User I/O Cable Pin assignments

Pin*	Input/Output (All I/O are user definable)	Available Function	Signal Type	Signal Range	Color
1	Digital in 1	See <a href="#">Table 5.6 Available Digital Input Functions</a>	Discrete Input	0 V to 24 V +/-10%, 12 mA	Blk
2	Digital in 2				Wht
3	Digital in 3				Red
4	Digital in 4				Grn
5	+24 V Supplied from DCX V Power Supply	N/A	24 V Source	24 V +/-10%, 250 mA Max	Orn
6					Blu
7	Digital out 1	See <a href="#">Table 5.7 Available Digital Output Functions</a>	Discrete Output	0 V to 24 V +/-10%, 25 mA Max	Wht/Blk
8	Digital out 2				Red/Blk
9	Digital out 3				Grn/Blk
10	Digital out 4				Orn/Blk
14	GND	N/A	24 V Ground	0 V	Grn/Wht
15					Blu/Wht
17	Analog in 1	See <a href="#">Table 5.8 Available Analog Input Functions</a>	Analog Input	0 V to +10 V, 2 mA	Wht/Red
18	Analog in 2				Orn/Red
24	Analog out 1	See <a href="#">Table 5.9 Available Analog Output Functions</a>	Analog Output	0 V to +10 V, 1 mA Max	Red/Blk/Wht
25	Analog out 2				Grn/Blk/Wht
26	Analog GND	N/A	Analog Ground	0 V	Orn/Blk/Wht

\* Pins 11, 12, 13, 16, and 19-23 are not used.

### 5.3.7 Available Digital Input Functions

**Table 5.6** Available Digital Input Functions

Function	Description
Cable Detect	Disables ultrasonics if 24 V signal is removed when using 0 V negative logic (active low) for the external Start input. Used to prevent ultrasonics from coming on if a cable is removed.
External Horn Scan	Starts horn scan sequence.
External Reset	Resets alarm conditions.
External Seek	Activates ultrasonic energy at 10% amplitude for the purpose of finding the ultrasonic stack resonant frequency.
External Start	<p>Activates ultrasonic energy at the currently set amplitude.</p> <p><b>NOTICE</b> DCX V Power Supply must be in ready mode before External Start.</p> <p><b>WARNING</b> When using 0 V to activate ultrasonics (External Start signal), it is recommended to assign one input as Cable Detect to prevent sonics from activating if 24 V is lost by accident.</p>
External Test	Performs a test cycle.
Memory Clear	Centers the power supply start frequency.

## 5.3.8 Available Digital Output Functions

**Table 5.7** Available Digital Output Functions

<b>Function</b>	<b>Description</b>
General Alarm	Indicates an alarm occurred.
Overload Alarm	Indicates an overload alarm has occurred.
Ready	Indicates the system is ready.
Seek/Scan Out	Indicates either a seek or a horn scan is in progress.
Sonics Active	Indicates sonics are active.

### 5.3.9 Available Analog Input Functions

**Table 5.8** Available Analog Input Functions

Function	Description		Valid Range
Amplitude In	Controls the amplitude of ultrasonic energy that will be delivered by the power supply.		1 V to 10 V* (10% to 100%)
Frequency Offset	Controls the frequency offset to the power supply operating frequency. Actual offset depends on the power supply operating frequency:		1 V to 9 V* (5 V is zero offset)
	Frequency	Offset Range	
	20 kHz	+/- 400 Hz	
	30 kHz	+/- 600 Hz	
	40 kHz	+/- 800 Hz	

\* If the input signals are not within their valid range, or if left unconnected, the power supply will use 50% amplitude and zero frequency offset, respectively.

## 5.3.10 Available Analog Output Functions

**Table 5.9** Available Analog Output Functions

Function	Description			Valid Range
Amplitude Out	Provides a 0 V to 10 V output signal proportional to amplitude (0% to 100%).			0 V to 10 V (0% to 100%)
Power Out	Provides a 0 V to 10 V output signal proportional to ultrasonic power output (0% to 100%).			0 V to 10 V (0% to 100%)
Frequency Out	Provides a 0 V to 10 V output signal that indicates relative frequency in memory. Actual frequency depends on the power supply operating frequency:			0 V to 10 V (5 V is zero offset)
	<b>Frequency</b>	<b>Lower Limit (0 V)</b>	<b>Upper Limit (10 V)</b>	
	20 kHz	19,450 Hz	20,450 Hz	
	30 kHz	29,250 Hz	30,750 Hz	
	40 kHz	38,900 Hz	40,900 Hz	

### 5.3.11 Default User I/O Connector Pin Assignments

**Table 5.10** Default User I/O Connector Pin Assignments

Pin*	Function	I/O Type	Values
1	External Start	Input Digital	Apply +24 VDC to run cycle <b>NOTICE</b> DCX V Power Supply must be in ready mode before External Start.
2	External Seek	Input Digital	Apply +24 VDC to perform a seek
3	External Reset	Input Digital	Apply +24 VDC to reset alarm
4	Memory Clear	Input Digital	Apply +24 VDC to clear memory
5 6	+24 VDC Source	I/O Signal Source	+24 V, 250 mA max.
7	Ready	Output Digital	+24 V indicates the system is ready
8	Sonics Active	Output Digital	+24 V indicates ultrasonics are active
9	General Alarm	Output Digital	+24 V indicates an alarm occurred
10	Seek/Scan Out	Output Digital	+24 V indicates either Seek or a Scan is in progress
14 15	+24 VDC Return and I/O Return	I/O Signal Return	Return for all pins except pins 17, 18, 24, and 25
17	Amplitude In	Input Analog	1 V to + 10 V (10% to 100%)**
18	Frequency Offset	Input Analog	1 V to + 9 V (5 V is zero offset)**
24	Power Out	Output Analog	0 V to + 10 V (0% to 100%)
25	Amplitude Out	Output Analog	0 V to + 10 V (0% to 100%)
26	Analog Signal Return	Analog Signal Return	Return for pins 17, 18, 24, and 25

\* Pins 11, 12, 13, 16, and 19-23 are not used.

\*\* If the input signals are not within their valid range, or if left unconnected, the power supply will use 50% amplitude and zero frequency offset, respectively.

## 5.3.12 Typical Digital I/O Wiring Examples

**Figure 5.8** Typical Digital I/O Wiring Examples

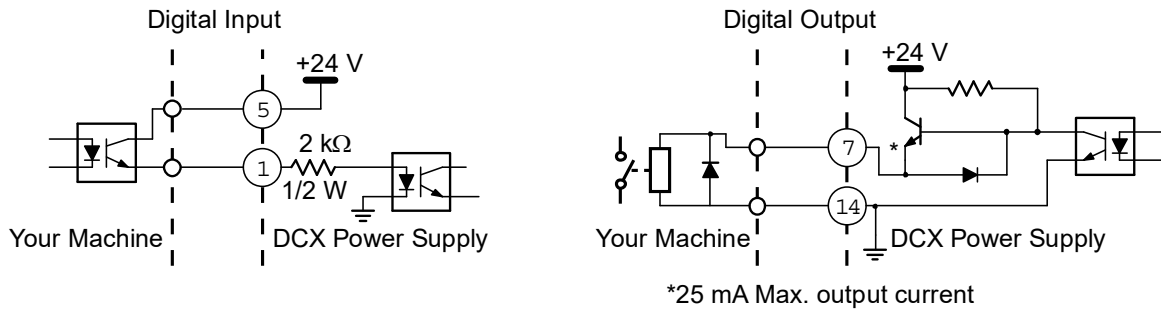

## 5.3.13 Typical Analog I/O Wiring Examples

**Figure 5.9** Typical Analog I/O Wiring Examples

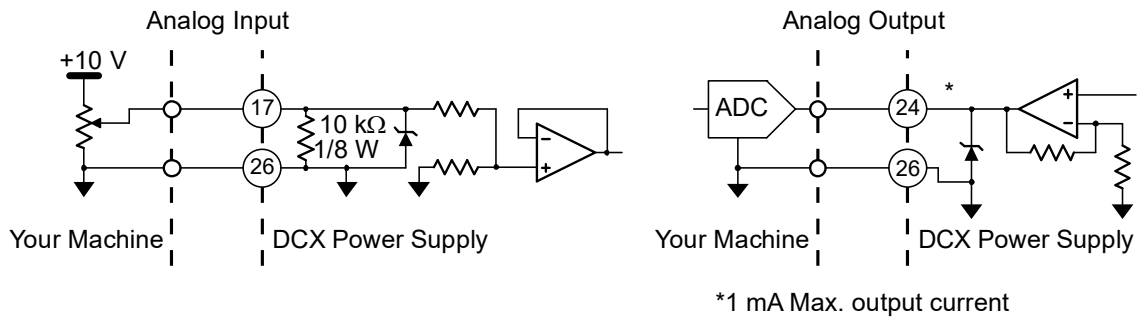



## 5.3.14 Output Power (RF Cable) Connection

Ultrasonic energy is delivered to the SHV connector on the power supply, which is then transmitted to the converter via the RF cable. The RF connector position depends on the power supply configuration. For Horizontal models it is located on the rear panel of the power supply. For Vertical models it is located on the bottom panel of the power supply.

To reduce electromagnetic interference (EMI), RF cables are equipped with a ferrite core (plastic case) on one end. This end is meant to be connected to the power supply.

WARNING	High Voltage Hazard
	Operating the System with the RF Cable disconnected or damaged can present an electrical shock hazard.

WARNING	High Voltage Hazard
	To avoid the possibility of electrical shock, converters need to be properly grounded.

NOTICE	
	To avoid the possibility of EMI interference, ensure the RF connection to the power supply is made with the cable end that has the ferrite core box attached (see <a href="#">Figure 5.10 RF Cable Connection</a> ).

**Figure 5.10** RF Cable Connection

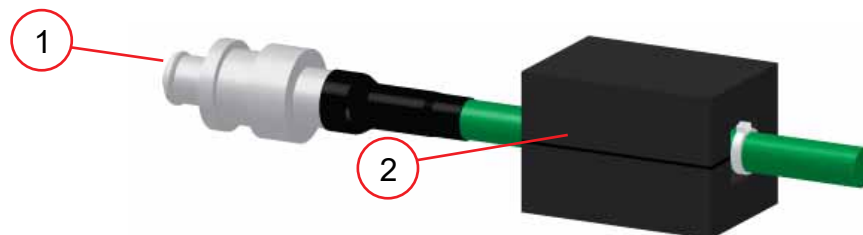



**Table 5.11** RF Cable Connection

Item	Description
1	To Power Supply
2	Ferrite Core Box

## 5.3.15 Input Power Connection

WARNING	High Voltage Hazard
	<p>Ensure all electrical power is off when wiring input power to your DCX V Power Supply connector block.</p> <p>To prevent the possibility of an electrical shock, ground the power supply by securing an 8 gage grounded conductor to the ground screw located next to the air outlet.</p>

WARNING	High Voltage Hazard
	<p>If miss-wired, the power supply can present an electrical shock hazard.</p>

NOTICE	
	<p>The power supply can be permanently damaged if it is connected to the incorrect line voltage, or if the connection is mis-wired.</p>

Use the following procedure to connect the power supply to a 24 VDC 2.5 A external power supply and to a single-phase, grounded, 3-wire, 50 Hz or 60 Hz 200 V to 230 V power source. The 24 VDC power supply must be safety certified and agency approved.

**Table 5.12** Input Power Connection

Step	Action
1	Detach the connector block on the back of the power supply.
2	Use two properly sized wires (according to local standards) to connect a 24 VDC 2.5A power supply as shown on <a href="#">5.3.4 Electrical Connections</a> .
3	Use three properly sized wires (No. 12 gage, 2.5 mm or according to local standards) to connect the line 1, line 2, and ground to the connector block as shown on <a href="#">5.3.4 Electrical Connections</a> . Choose wires according to the current rating as specified in <a href="#">Table 5.2 Input Current and Circuit Breaker Specifications</a> and on the label located on the back of the unit. Be sure to use agency approved wiring and use sleeving or tubing on each wire for double insulation.
4	Secure an 8 gage grounded conductor to the ground screw located next to the air outlet.

**Table 5.12** Input Power Connection

Step	Action
5	Connect the converter-booster-horn stack to the power supply using the RF cable. See <a href="#">5.3.14 Output Power (RF Cable) Connection</a> .
6	Ensure the power switch on the back of the unit is in the OFF position. Plug the connector block back into the power supply. Tighten the two securing screws.
7	Connect the power supply to a single-phase, grounded, 3-wire, 50 Hz or 60 Hz 200 V to 230 V power source.

NOTICE	
	To avoid a power-on alarm, ensure 230 VAC are present for at least 1 second before supplying the 24 VDC.

## 5.4 Power Supply Configuration

### 5.4.1 Selecting the Alarm Mode

The DCX V Power Supply activates ultrasonic power after receiving an External Start signal. Ultrasonic power remains on until you turn off the power supply or the External Start signal. The DCX V Power Supply response to alarm conditions can be configured to operate in one of two modes:

- **Latching:** In this mode the DCX V Power Supply requires alarm conditions to be reset before a new weld cycle can begin. To reset alarm conditions while in this mode, either press the front panel Reset key or send an External Reset signal using the user I/O connector
- **Non-Latching:** In this mode the DCX V Power Supply does not require alarm conditions to be reset, and new weld cycle can begin upon receiving an External Start signal

The alarm mode is factory-set to non-latching. For instruction on how to change the alarm mode refer to [7.4 Web Page Interface](#) in [Chapter 7: Operation](#) and to your DCX V Power Supply Web Page Interface Instruction Manual (4000843).

### 5.4.2 Configuring the Power Supply



Certain power supply configurations can be modified from the factory setting if needed. Although not usually requiring modifications from the factory setting, the following features are selectable:

- **Amplitude Control:** Allows for varying the amplitude (10% to 100%) using the web page interface, or by way of external controls (analog signal applied through the user I/O analog input)
- **Latching Alarms:** Provides an option for selecting the power supply alarms to be latching (reset required) or non-latching (reset by reapplying the start signal)
- **Start Ramp Time:** Provides a selection for different start ramp times. This controls how fast the amplitude of the horn rises from zero to the currently set amplitude. Long ramp times may be useful when using large horns or high gain stacks
- **End of Weld Frequency Store:** Provides an option for selecting if the stack frequency is stored at the end of each weld cycle
- **Seek Ramp Time:** Provides a selection for different power supply seek ramp times
- **Timed Seek:** Provides an option for monitoring, and storing the operating frequency at timed intervals (60 seconds). Periodic frequency seeks may be helpful when welder is not used for long periods of time. Seeks are timed from the moment sonics was last activated
- **Seek Time:** Provides an option for selecting seek duration
- **Frequency Offset:** Allows for varying the start frequency by way of external controls (analog signal applied through the user I/O analog input) or setting a fixed value using the web page interface. This is useful for certain applications, where the force imparted on the fixture or anvil causes a frequency shift in the stack's operation

For instruction on how to change the power supply settings refer to [7.4 Web Page Interface](#) in [Chapter 7: Operation](#) and to your DCX V Power Supply Web Page Interface Instruction Manual (4000843).

NOTICE	
	Consult with Branson before changing any default factory setting.

## 5.5 Assembling the Acoustic Stack

CAUTION	General Warning
	<p>The following procedure must be performed by a setup person. If necessary, secure the largest portion of a square or rectangular horn in a soft jawed vise. NEVER attempt to assemble or remove a horn by holding the converter housing or the booster clamp ring in a vise.</p>
CAUTION	General Warning
	<p>Do not use silicone grease with Mylar<sup>®</sup> plastic film washers. Use only 1 (one) Mylar<sup>®</sup> plastic film washer of the correct inside and outside diameters at each interface.</p>
NOTICE	
	<p>The use of a Branson torque wrench or the equivalent is recommended. P/N 101-063-787 for 20 kHz, and 30 kHz systems and 101-063-618 for 40 kHz systems.</p>

**Figure 5.11** Assembling the Acoustic Stack

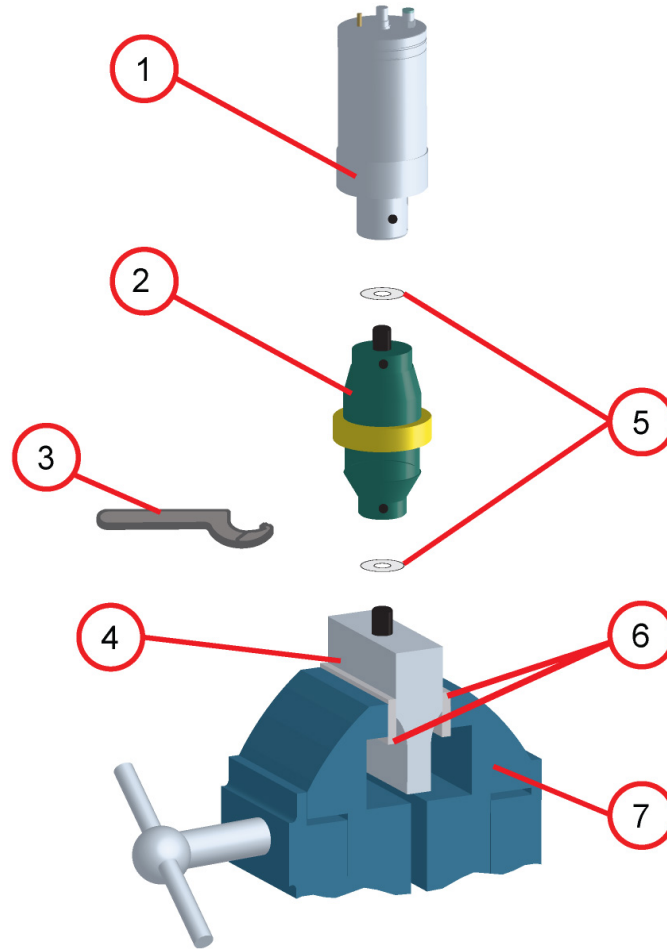

**Table 5.13** Acoustic Stack Description

Item	Description
1	Converter
2	Booster
3	Spanner (provided)
4	Horn
5	See stack assembly procedure
6	Vise Jaw protectors (aluminum or soft metal)
7	Vise

**Table 5.14** Stack Torque Values

Frequency	Torque
20 kHz	220 in·lb (24.85 N·m)
30 kHz	185 in·lb (21 N·m)
40 kHz	95 in·lb (10.73 N·m)

**Table 5.15** Tools

<b>Tool</b>	<b>EDP Number</b>
20 kHz, and 30 kHz Torque Wrench Kit	101-063-787
40 kHz Torque Wrench	101-063-618
20 kHz Spanner Wrench	101-118-039
30 kHz Spanner Wrench	201-118-033
40 kHz Spanner Wrench	201-118-024
Silicone Grease	101-053-002
Mylar <sup>®</sup> Plastic Film Washers (20 kHz)	100-063-357
Mylar <sup>®</sup> Plastic Film Washers (30 kHz)	100-063-632

## 5.5.1 For a 20 kHz System

**Table 5.16** 20 kHz System

Step	Action
1	Ensure that the mating surfaces of the converter, booster, and horn are clean, and that the threaded holes are free of foreign material.
2	Install a single Mylar <sup>®</sup> plastic film washer (matching the size of the washer to the stud) to each interface.
3	Assemble the converter to the booster and the booster to the horn.
4	Torque to 220 in·lb (24.85 N·m) at each interface.

## 5.5.2 For a 30 kHz System

**Table 5.17** 30 kHz System

Step	Action
1	Ensure that the mating surfaces of the converter, booster, and horn are clean, and that the threaded holes are free of foreign material.
2	Install a single Mylar <sup>®</sup> plastic film washer (matching the size of the washer to the stud) to each interface.
3	Assemble the converter to the booster and the booster to the horn.
4	Torque to 185 in·lb (21 N·m) at each interface.

## 5.5.3 For a 40 kHz System

**Table 5.18** 40 kHz System

Step	Action
1	Ensure that the mating surfaces of the converter, booster, and horn are clean, and that the threaded holes are free of foreign material.
2	Coat each interface surface with a thin film of silicon grease - but do not apply silicon grease to a threaded stud or tip.
3	Assemble the converter to the booster and the booster to the horn.
4	Torque to 95 in·lb (10.73 N·m) at each interface.

### 5.5.4 Connecting Tip to Horn

Ensure that the mating surfaces of the tip and horn are clean. Remove any foreign matter from the threaded stud and hole.

Hand assemble the tip to the horn. Assemble dry. Do not use any silicone grease.

Use the spanner wrench and an open-end wrench (refer to [Figure 5.12 Connecting Tip to Horn](#)) and tighten to the following torque tip specifications:

**Figure 5.12** Connecting Tip to Horn

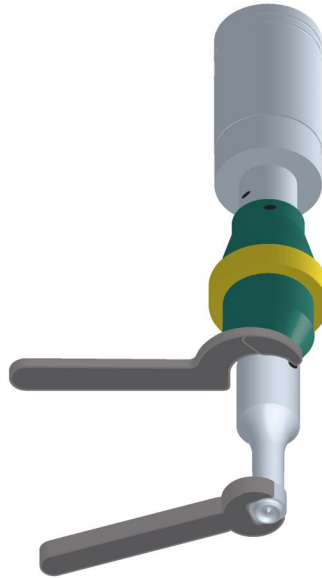

**Table 5.19** Tip to Horn Values

Tip Thread	Torque
1/4 - 28	110 in·lbs (12.42 N·m)
3/8 - 24	180 in·lbs (20.33 N·m)

## 5.6 Converter Cooling

Converter performance and reliability can be adversely affected if the converter ceramics are subjected to temperatures above 140° F (60° C). The converter front driver temperature should not exceed 122° F (50° C).

To prolong converter life and maintain a high degree of system reliability, the converter should be cooled with clean, dry, compressed air, particularly if your application calls for continuous ultrasonic operation. Converter cooling is especially critical in 40 kHz applications.

Use one of the following procedures to determine if a converter is operating close to the maximum allowable temperature. Check converter temperature immediately after substantial machine operation and without power applied to the horn.

- Press a pyrometer probe (or similar temperature measuring device) against the front driver of the converter assembly. Wait for the probe to reach the temperature of the shell. If the temperature is 120° F (49° C) or higher, the converter requires a cooling air stream
- If a temperature measuring device is unavailable, use your hand to feel the shell of the converter. If the converter is hot to touch, the converter requires a cooling air stream

High duty cycles require additional cooling for the converter. System average power must be limited to the specified continuous maximum. Higher peak power, up to the maximum acceptable power limit, with an on time of up to 10 seconds may be obtained, if appropriate off time ensures that, on average, the continuous duty maximum power is not exceeded.

**Table 5.20** Continuous Duty Max. Power & Full Power Duty Cycle

Configuration	Continuous Duty Max. Power	Full Power Duty Cycle
20 kHz / 1250 W	800 W	10 s on 10 s off (50% Duty Cycle)
20 kHz / 2500 W	1600 W	10 s on 10 s off (50% Duty Cycle)
20 kHz / 4000 W	2000 W	5 s on 15 s off (25% Duty Cycle)
30 kHz / 750 W	300 W	2 s on 2 s off (50% Duty Cycle)
30 kHz / 1500 W	800 W	2 s on 2 s off (50% Duty Cycle)
40 kHz / 400 W	300 W	10 s on 10 s off (50% Duty Cycle)
40 kHz / 800 W	400 W	10 s on 10 s off (50% Duty Cycle)

If converter cooling is required, use the following steps:

**Table 5.21** Converter Cooling Procedure

Step	Action
1	Start with a 50 psi (345 kPa) air source or higher from a 0.06 in (1.5 mm) I.D. orifice.
2	Perform a run of welding operations.
3	Immediately after completing the welding run, check the converter temperature.
4	If the converter is still too hot, increase the diameter of the orifice in small increments until the temperature falls within the ranges in the chart.

A 0.06 in (1.5 mm) orifice at 50 psi (345 kPa) will result in a reading of 80 ft<sup>3</sup> (2.26 m<sup>3</sup>) per hour. This should be sufficient to cool most operations requiring a cooling air stream. In continuous welding operations, or applications with longer duty cycles, it may be necessary to cool the horn as well as the converter. Horns may require cooling because of the heat transfer from contacting the work piece.

## 5.7 Testing the Installation

To test the power supply follow the procedure described in [7.5 Ultrasonics Test Procedure](#) in [Chapter 7: Operation](#).

## 5.8 Still Need Help?

Branson is pleased that you chose our product and we are here for you! If you need parts or technical assistance with your DCX V Power Supply system, call your local Branson representative. Please refer [1.3 How to Contact Branson](#) for a list of Branson key contacts.



---

# **Chapter 6: Converters and Boosters**

---

**6.1 Converters and Boosters . . . . . 78**

## 6.1 Converters and Boosters

A variety of converters and boosters available for use with the DCX V Power Supply are illustrated in the following pages.

<b>WARNING</b>	<b>High Voltage Hazard</b>
	To avoid the possibility of electrical shock, converters need to be properly grounded.

**Figure 6.1** 20 kHz typical Converter Dimensions

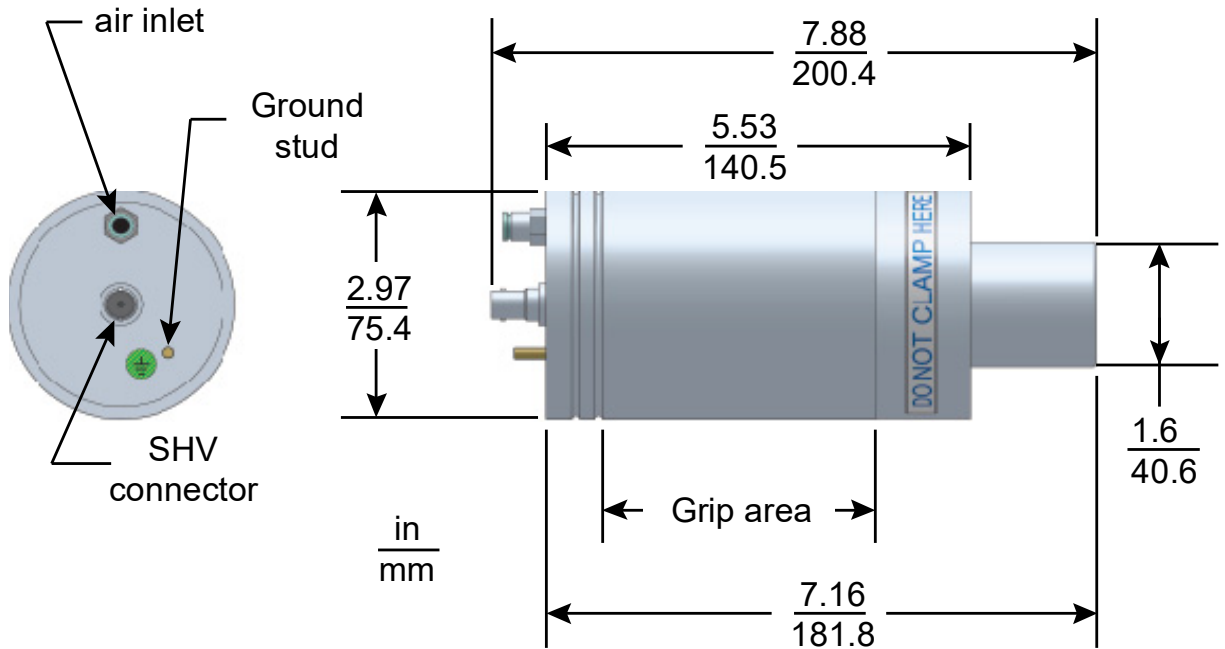

**Table 6.1** 20 kHz Converter

Item	Description
1	Air inlet
2	Ground stud
3	SHV connector
4	Grip area

**Figure 6.2** 20 kHz Booster Dimensions

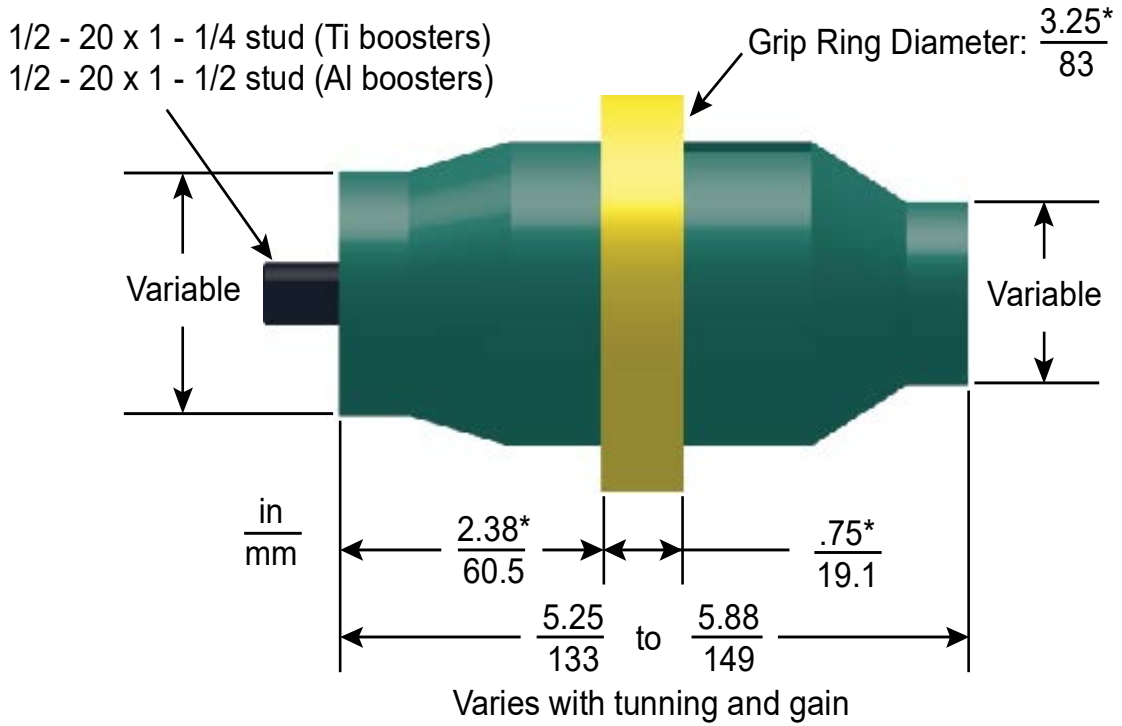

\*These dimensions do not vary

**Table 6.2** 20 kHz Booster

Item	Description
1	1/2 - 20 x 1 - 1/4 stud (Ti boosters) 1/2 - 20 x 1 - 1/2 stud (Al boosters)
2	Grip Ring Diameter
3	Variable
4	Varies with tuning and gain

\* These dimensions do not vary.

**Figure 6.3** 20 kHz Converter/Booster/Horn, Typical Dimensions

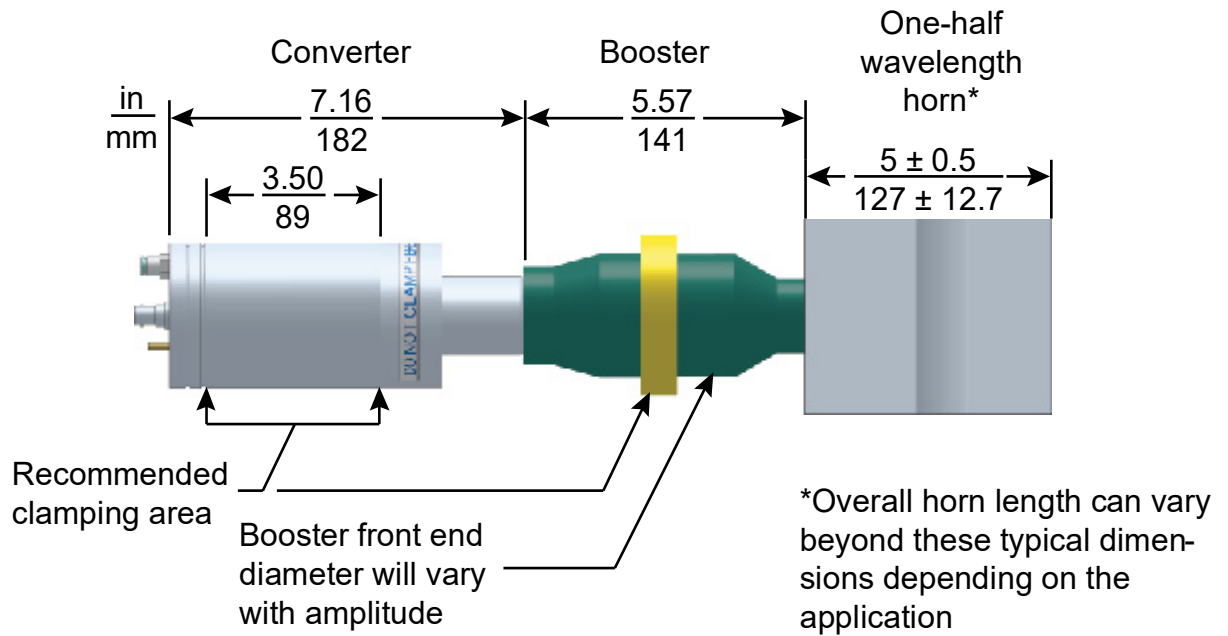
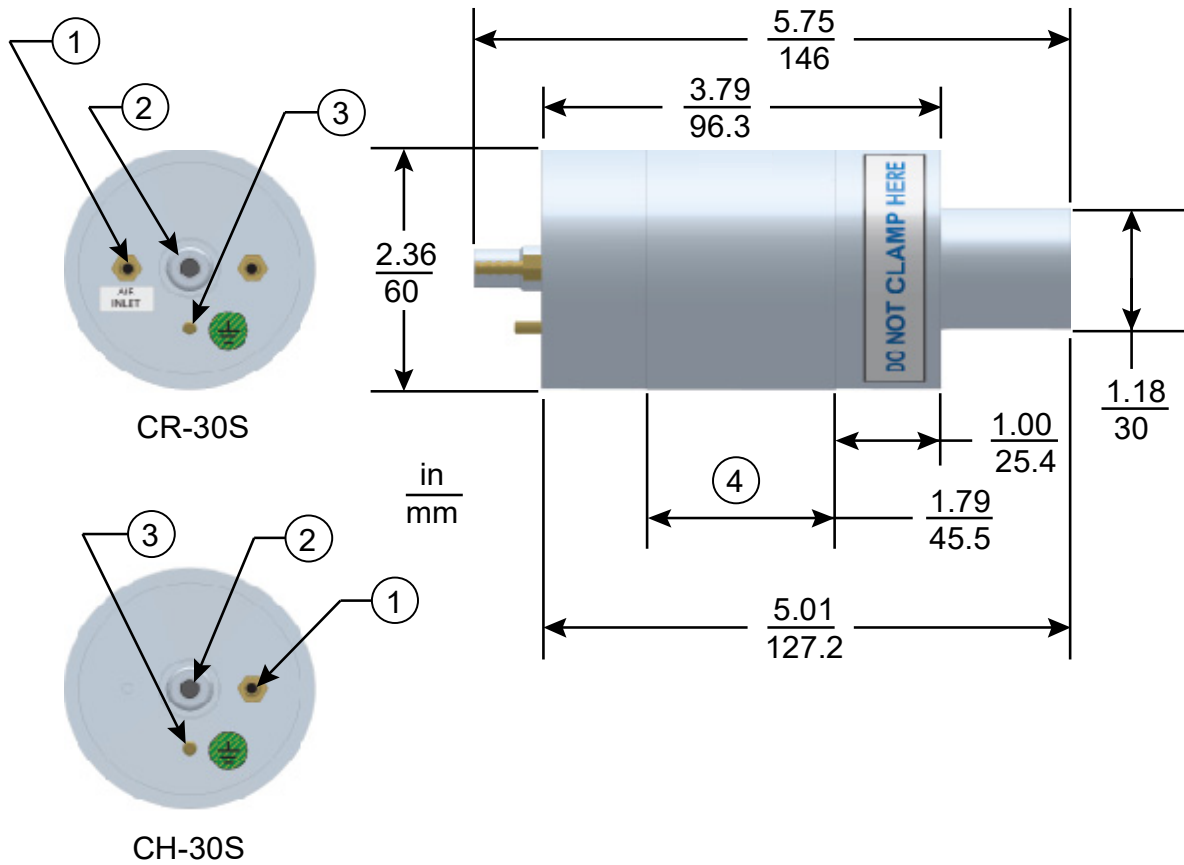

**Table 6.3** 20 kHz Converter/Booster/Horn

Item	Description
1	Converter
2	Booster
3	One-half wavelength horn
4	Recommended clamping area
5	Booster front end diameter will vary with amplitude

\* Overall horn length can vary beyond these typical dimensions depending on the application.

**Figure 6.4** 30 kHz Converter Dimensions



**Table 6.4** 30 kHz Converter

Item	Description
1	Air inlet
2	SHV connector
3	Ground stud
4	Grip area

CR-30S and CH-30S are dimensionally identical, and differ only in their respective cooling feature.

CR-30S has flow through cooling, and CH-30S has closed loop cooling (air circulates in the converter and returns to its source).

**Figure 6.5** 30 kHz Booster Dimensions

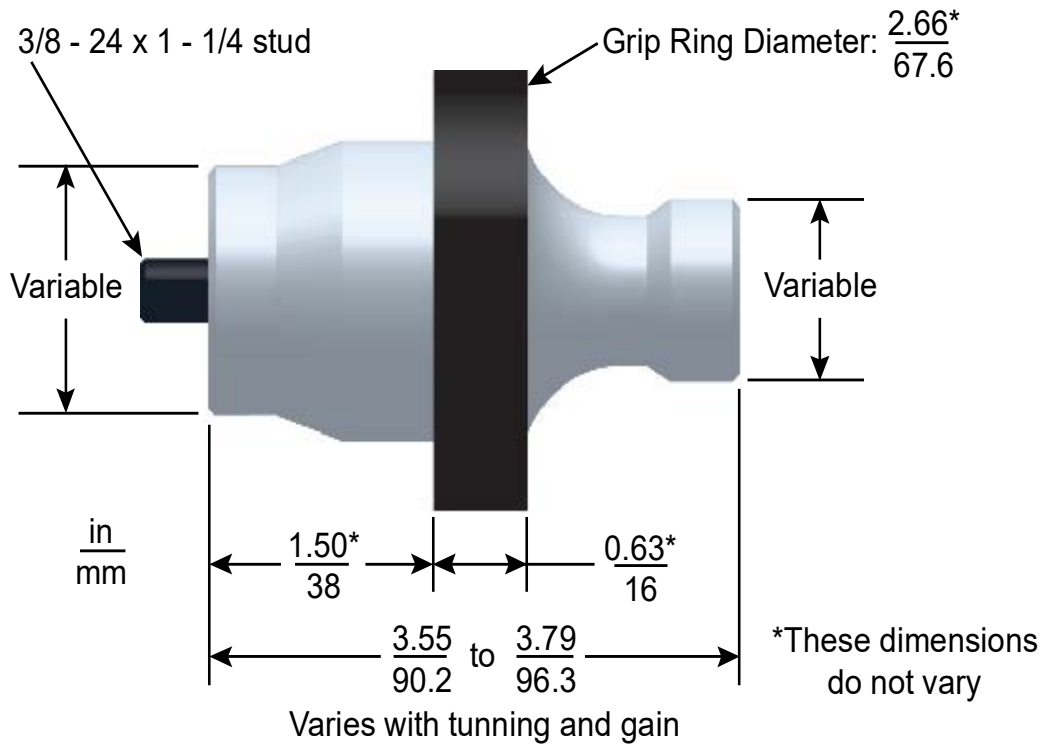
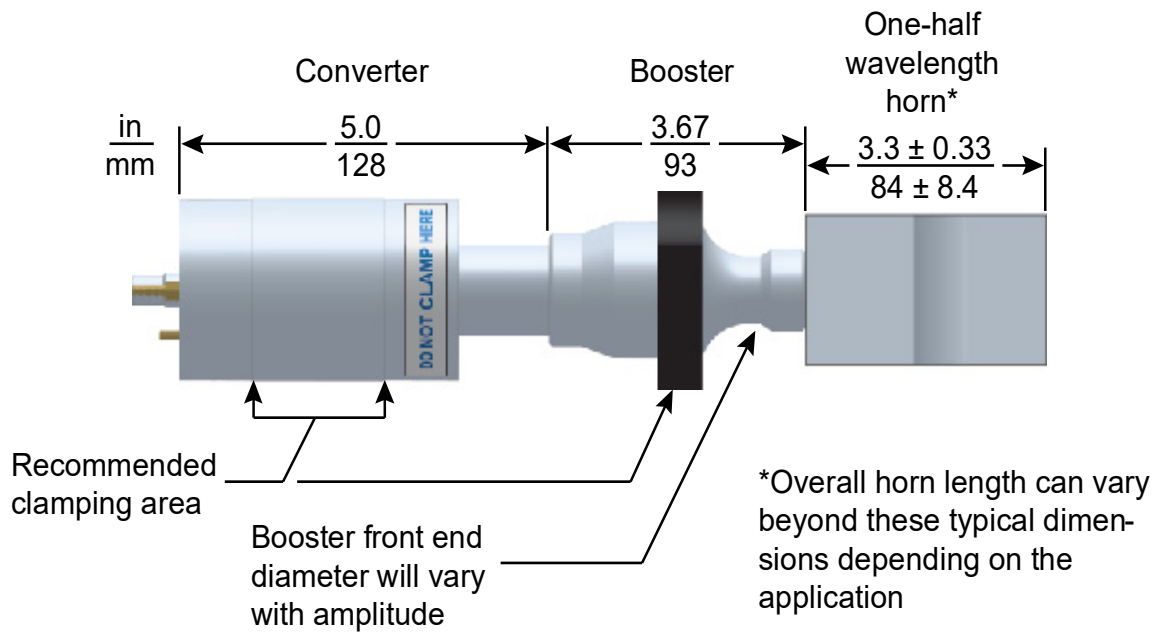

**Table 6.5** 30 kHz Booster

Item	Description
1	3/8 - 24 x 1 - 1/4 stud
2	Grip Ring Diameter
3	Variable
4	Varies with tuning and gain

\* These dimensions do not vary.

**Figure 6.6** 30 kHz Converter/Booster/Horn, Typical Dimensions

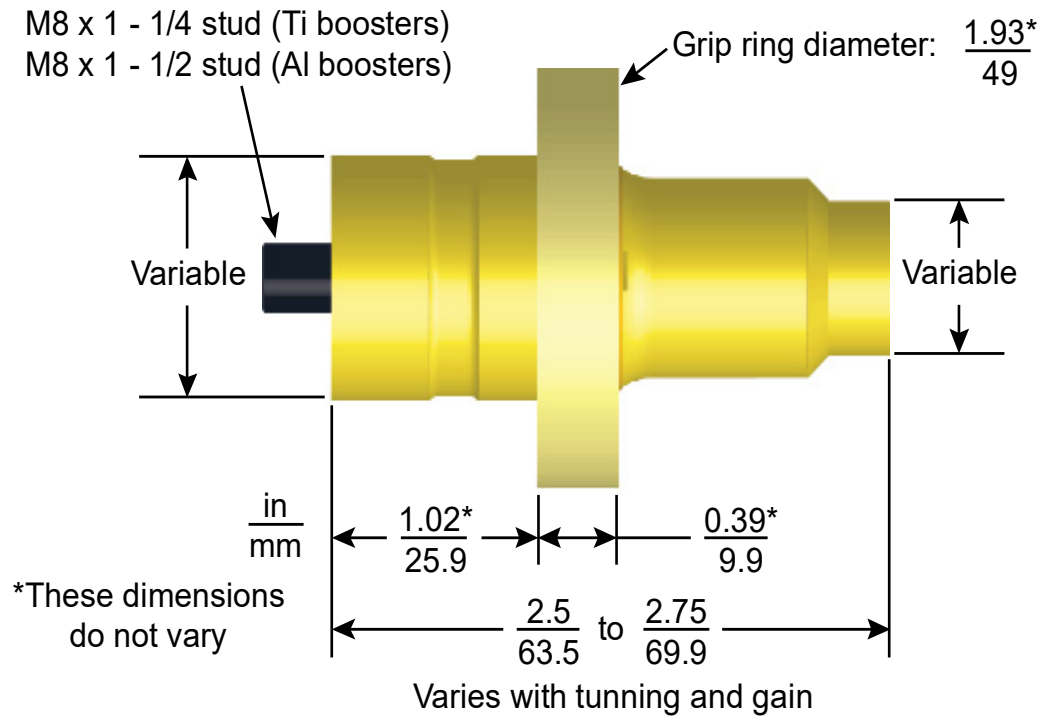

**Table 6.6** 30 kHz Converter/Booster/Horn

Item	Description
1	Converter
2	Booster
3	One-half wavelength horn
4	Recommended clamping area
5	Booster front end diameter will vary with amplitude

\* Overall horn length can vary beyond these typical dimensions depending on the application.

**Figure 6.7** 40 kHz Booster Dimensions



**Table 6.7** 40 kHz Booster

Item	Description
1	M8 x 1 - 1/4 stud (Ti boosters) M8 x 1 - 1/2 stud (Al boosters)
2	Grip ring diameter
3	Variable
4	Varies with tuning and gain

**Figure 6.8** 40 kHz Converter/Booster/Horn, Typical Dimensions

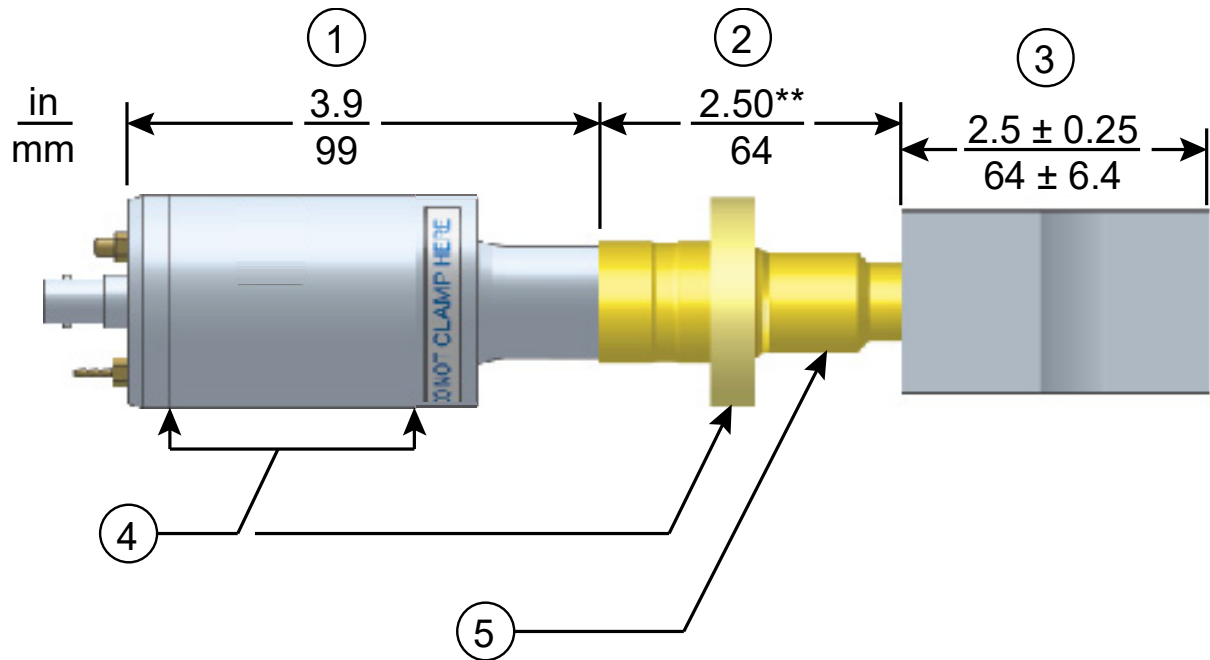

**Table 6.8** 40 kHz Converter/Booster/Horn

Item	Description
1	Converter
2	Booster
3	One-half wavelength horn
4	Recommended clamping area
5	Booster front end diameter will vary with amplitude

\* Overall horn length can vary beyond these typical dimensions depending on the application.

\*\* Dimension varies with tuning and gain.

## 6.1.1 Component Functional Description

### Ultrasonic Stack

#### Converter

The converter is mounted in the customer's automation as part of the ultrasonic stack. The ultrasonic electrical energy from the power supply is applied to the converter (sometimes called the transducer). This transforms the high frequency electrical oscillations into mechanical vibrations at the same frequency as the electrical oscillations. The heart of the converter are piezoelectric ceramic elements. When subjected to an alternating voltage, these elements alternately expand and contract, resulting in better than 90% conversion of electrical to mechanical energy.

#### Booster

It is important to be able to modify the horn face amplitude for successful ultrasonic assembly. The booster provides a means to modify the amplitude. It is designed to couple different ratios of ultrasonic energy to the horn, which will in turn increase or decrease the amplitude at the face of the horn. This is accomplished by varying the ratios of the masses of the input and output half sections of the booster.

The booster is a resonant half-wave section of aluminum or titanium. It is mounted between the converter and the horn, as part of the ultrasonic stack. It also provides a clamping point for rigid stack mounting.

#### Horn

The horn is selected or designed for a specific application. Each horn is tuned typically as a half-wave section that applies the necessary force and vibration uniformly to the parts to be assembled. It transfers ultrasonic vibrations from the converter to the workpiece. The horn is mounted to the booster as part of the ultrasonic stack.

Depending on their profile, horns are referred to as stepped, conical, exponential, bar, or catenoidal. The shape of the horn determines the amplitude at the face of the horn. Depending on the application, horns can be made from titanium alloys, aluminum, or steel. Titanium alloys are the best materials for horn fabrication due to their high level of strength and low loss. Aluminum horns are usually chrome- or nickel-plated or hard-coated to reduce wear. Steel horns are for low amplitude requiring hardness, such as ultrasonic insertion applications.

#### Solid Mount Boosters

The solid mount booster is a one-half wave-length resonant section made exclusively of titanium. It is mounted between the converter and the horn, modifying the amplitude of vibration applied to the horn and providing a clamping point.

The solid mount booster is superior to prior versions in that deflection is minimized. This is the result of a redesigned clamp-ring which employs a metal-to-metal press fit rather than an O-ring assembly.

The advantage this booster offers is its improved rigidity. For continuous applications, this means more energy delivered to the product, while in plunge applications, improved alignment is possible. The solid mount provides improved positional alignment and will benefit continuous applications where high force, high side load, or high cycle rates are necessary. In plunge welding applications, overall deflection is reduced by an average of 0.0025 in. (0.064 mm) over a wide variety of materials, joint designs, and operating conditions. The results of this testing in combination with information drawn from field testing indicate that the solid mount will benefit plunge applications where precision alignment is necessary (such as staking, swaging, or insertion) or where concentricity/parallelism is critical.



---

## **Chapter 7: Operation**

---

<b>7.1</b>	<b>Activating Ultrasonic Power</b> .....	<b>90</b>
<b>7.2</b>	<b>Setting the Amplitude</b> .....	<b>91</b>
<b>7.3</b>	<b>Resetting the Power Supply Alarms</b> .....	<b>92</b>
<b>7.4</b>	<b>Web Page Interface.</b> .....	<b>93</b>
<b>7.5</b>	<b>Ultrasonics Test Procedure</b> .....	<b>97</b>

## 7.1 Activating Ultrasonic Power

On DCX V Power Supply, ultrasonic power activates after receiving an External Start signal at the corresponding user I/O.

NOTICE	
	DCX V Power Supply must be in ready mode before External Start.

Ultrasonic power remains On until you turn off the power supply or the External Start signal. For default user I/O assignment see [5.3.5 User I/O Connections](#). For information on configuring the power supply user I/O refer to your DCX V Power Supply Web Page Interface Instruction Manual (4000843).

## **7.2 Setting the Amplitude**

### **7.2.1 Using External Amplitude Control**

The ultrasonic amplitude can be controlled using one of the two analog input pins on the user I/O connector (pins 17 and 18). For more information and wiring examples see [5.3.5 User I/O Connections](#). For information on configuring the power supply user I/O refer to your DCX V Power Supply Web Page Interface Instruction Manual (4000843).

### **7.2.2 Using the Web Page Interface**

The ultrasonic amplitude can be set to a user specified value using the web page interface. For more information, refer to your DCX V Power Supply Web Page Interface Instruction Manual (4000843).

## 7.3 Resetting the Power Supply Alarms

You need to reset the weld system when you get an overload. When there is an overload, the General Alarm output on the user I/O connector becomes active. The procedure for resetting the power supply depends on the power supply alarm settings. Refer to [Table 7.1 Resetting the DCX V Power Supply](#) for reset procedures.

**Table 7.1** Resetting the DCX V Power Supply

Alarm Setting	Reset Procedure
Latching Alarms	Press the front panel Reset key. You can also send an External Reset signal.
Non-Latching Alarms	Remove and re-apply the start signal.

NOTICE	
	Alarm circuitry requires at least 20 ms before restarting ultrasonic power.

For more information on interfacing the DCX V Power Supply using the user I/O connections refer to [5.3.5 User I/O Connections](#) in [Chapter 5: Installation and Setup](#).

## 7.4 Web Page Interface

The DCX V Power Supply Web Page Interface provides access, via Ethernet connection, to power supply information, diagnostics, and configuration web pages. Communication can be established point-to-point or through a local area network.

### 7.4.1 System Requirements

To connect to the DCX V Power Supply Web Page Interface you will need a PC running a Windows<sup>®1</sup> operating system with a Chrome<sup>™2</sup> or Edge<sup>®1</sup> web browser software.

### 7.4.2 Connecting to the Web Page Interface

NOTICE	
	<p>The DCX V Power Supply is not compatible with network scanning software. If your local network uses these types of programs, the DCX V Power Supply IP address must be placed in an exclusion list.</p>

NOTICE	
	<p>A shielded Ethernet cable should be used to connect to the DCX V Power Supply Web Page Interface to prevent possible EMI (Electromagnetic Interference) issues.</p>

### 7.4.3 Point to Point Connection (Windows 10<sup>®</sup> or Windows 11<sup>®</sup>)

To connect directly to the DCX V Power Supply Web Page Interface using a PC with Windows 10<sup>®1</sup> or Windows 11<sup>®1</sup> operating system, complete the following steps:

1. Connect the power supply to a computer via the Ethernet port.
2. Turn on the power supply.
3. On your PC, click the Start button on the taskbar and search for the **Control Panel**.
4. Select **View Large Icons** on the top right corner.
5. Select **Network and Sharing Center**.

---

1. Windows, and Microsoft Edge are registered trademarks of Microsoft Corporation.  
2. Google Chrome is a trademark of Google LLC.

6. Select **Change adapter settings**.

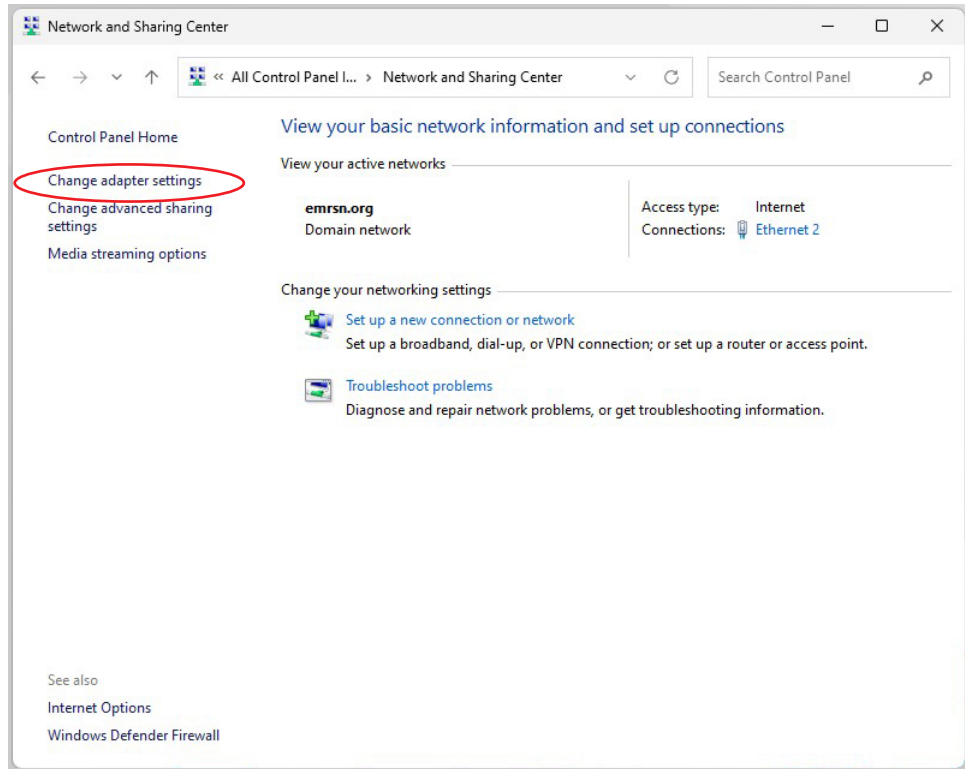

7. Right click on **Ethernet 2** and select **Properties** to bring up the **Networking** tab. You might be prompted to elevate rights to do this change.

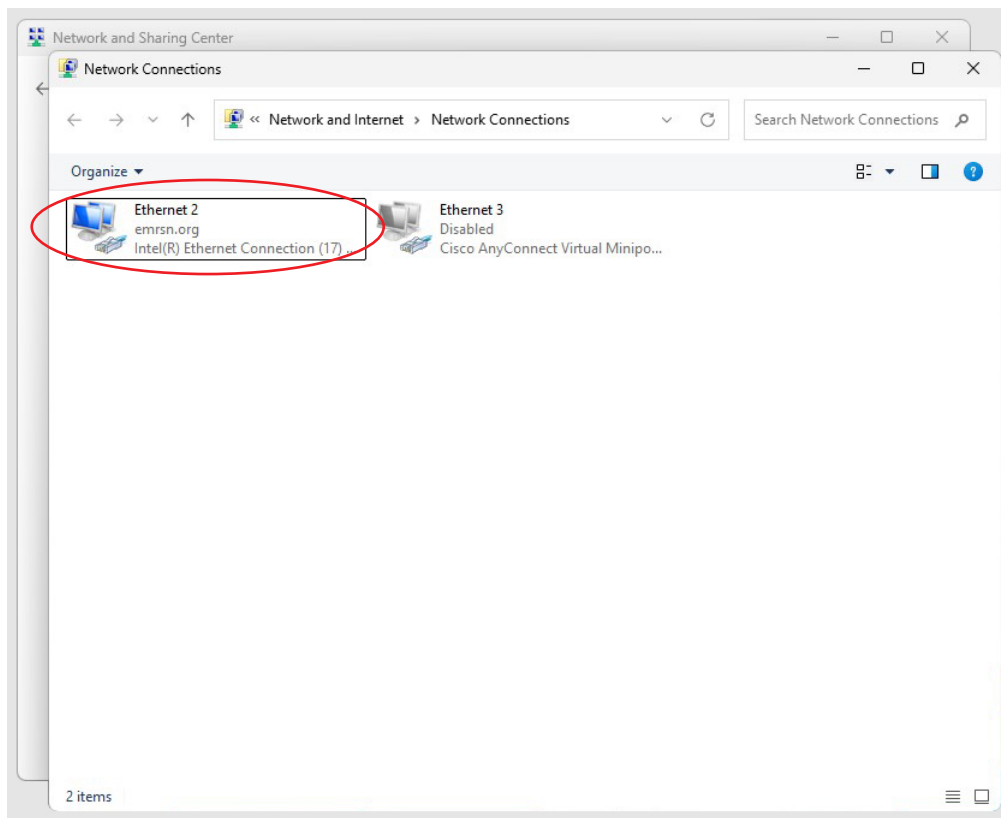

8. Highlight **Internet Protocol Version 4 (TCP/IPv4)** from the list and click on **Properties**.

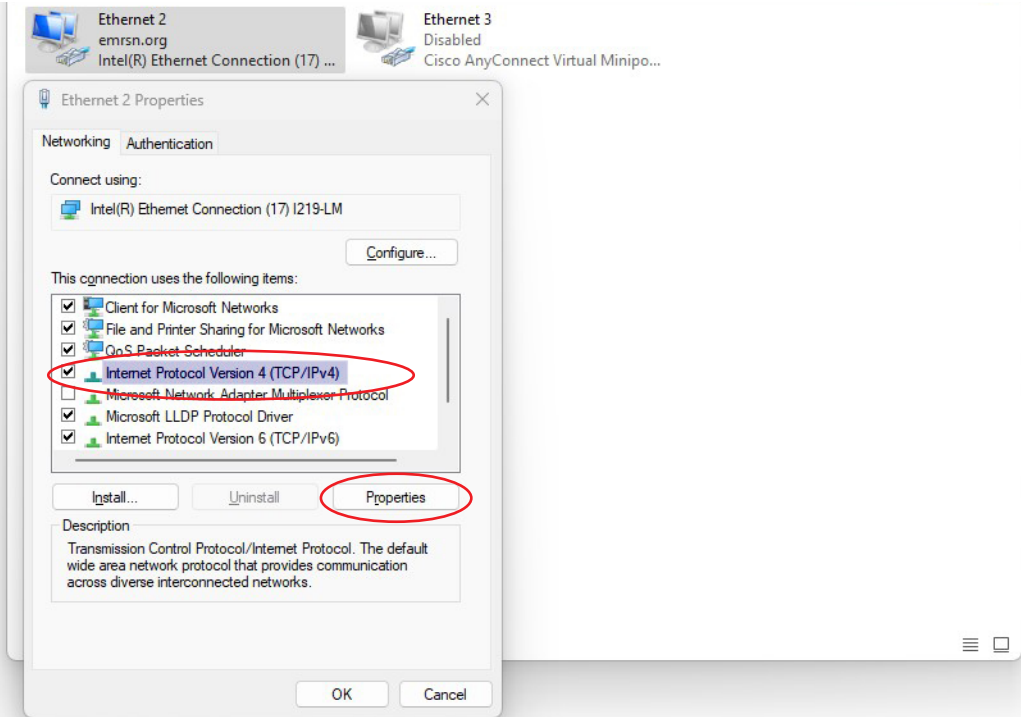

9. Use the following IP address:

**IP address:** 192.168.10.101

**Subnet mask:** 255.255.255.0

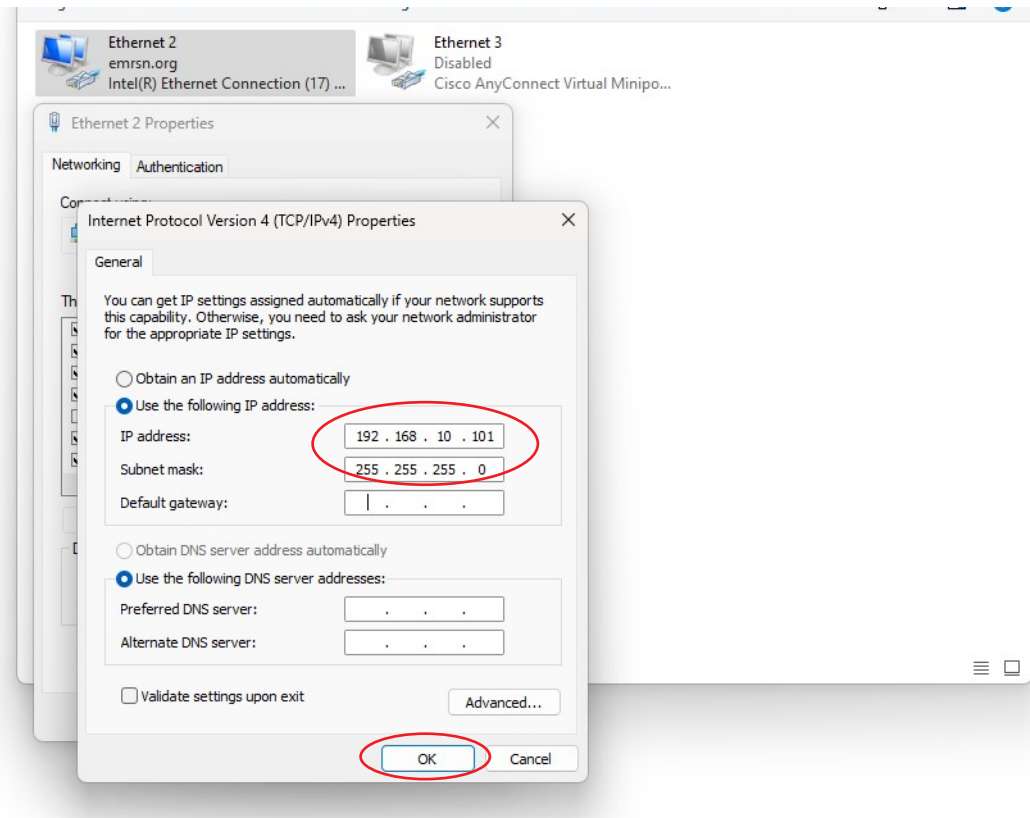

10. Click **OK**. Close the rest of the dialog boxes.

11. Open the Chrome™ or Edge® web browser.
12. In the address bar type the following address: <http://192.168.10.100>. Press Enter.
13. This will bring up the DCX V Power Supply Web Page Interface.
14. Enter a user ID number (any number up to 9 digits long).

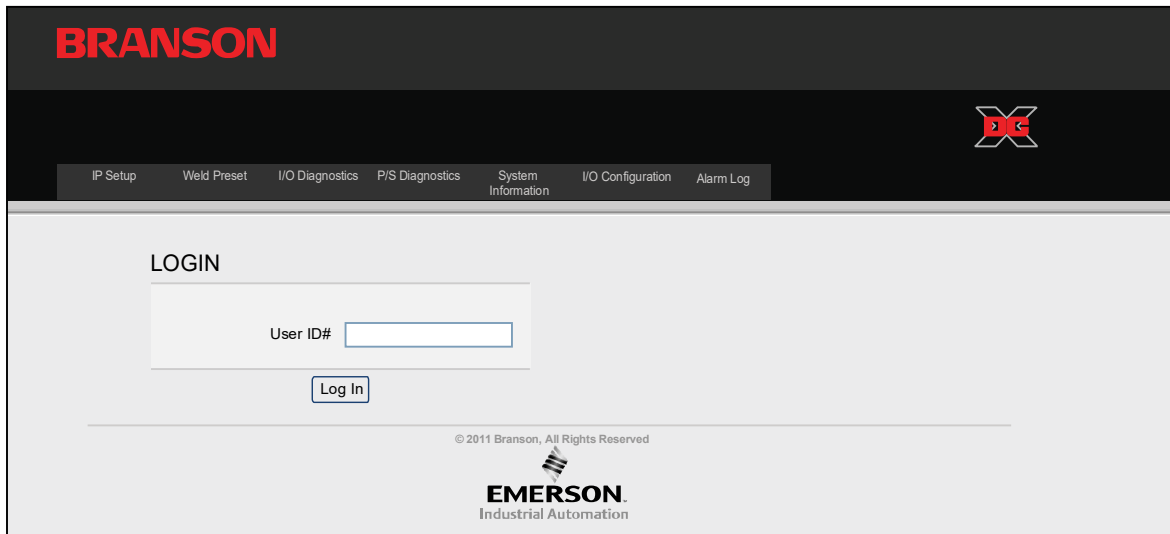



#### 7.4.4 Using the Web Page Interface

For complete instructions detailing the web page interface consult the DCX V Power Supply Web Page Interface Instruction Manual (4000843).

## 7.5 Ultrasonics Test Procedure

The Ultrasonics Test function measures ultrasonic power dissipated by the ultrasonic stack with no load. Autotune with Memory (ATM) function ensures that the power supply does not require any manual adjustments. The ultrasonics test procedure involves an automatic matching of the frequency of the power supply to the frequency of the converter-booster-horn stack.

<b>WARNING</b>	<b>High Voltage Hazard</b>
	<p>Ensure that no one is in contact with the horn when testing the power supply.</p> <p>Do not cycle the welding system if either the RF cable or converter is disconnected.</p>
<b>WARNING</b>	<b>High Voltage Hazard</b>
	<p>Ensure the power supply is properly connected, as indicated in <a href="#">5.3 Installation Steps</a>.</p>
<b>NOTICE</b>	
	<p>To avoid a power-on alarm, ensure 230 VAC are present for at least 1 second before supplying the 24 VDC.</p>

## 7.5.1 Using the I/O Connections

**Table 7.2** Power Supply Ultrasonic Test Procedure (User I/O)

Step	Action
1	Wire the necessary I/O signals as shown on <a href="#">Figure 7.1 Test Connections</a> , or using a similar setup.
2	Turn on the power supply. The front panel Power and 24 VDC LEDs should turn on. Ready Signal should become active.
3	Send an External Start signal for 1-2 seconds. The Sonics Active output will become active while the External Start Signal is present. If the General Alarm output does not become active, the test procedure is finished.
4	If the General Alarm output becomes active, send an External Reset signal and repeat step 2 one time only. If the alarm persists, refer to <a href="#">8.6 Troubleshooting</a> .

**Figure 7.1** Test Connections

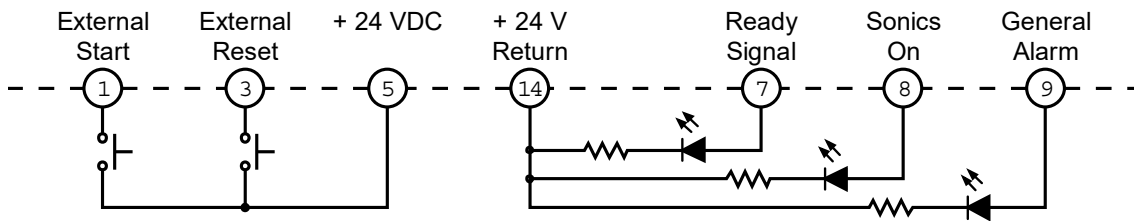

## 7.5.2 Using the Web page interface

**Table 7.3** Power Supply Ultrasonic Test Procedure (Web Page Interface)

Step	Action
1	Turn on the power supply. The front panel Power LED should turn on.
2	Connect to the DCX V Power Supply Web Page Interface. See <a href="#">7.4.2 Connecting to the Web Page Interface</a> .
3	<p>Go to the <b>P/S Diagnostics</b> tab. Press the <b>Start Test</b> button to start the test. Sonics will become active and the button will change to <b>Stop Test</b>. Press the button again to stop the test.</p> <p>If the <b>OK - Memory Stored</b> indicator becomes active the test procedure is finished.</p> <p><b>NOTICE</b> Low level ultrasonic energy will remain active until the Stop Test button is pressed. If you close the web browser, ultrasonic energy will turn off automatically after 5 seconds.</p>
4	If the <b>Overload - Memory Cleared</b> indicator becomes active the test will be interrupted, press the <b>Reset Overload</b> button and repeat step 3 one time only. If the alarm persists, refer to <a href="#">8.6 Troubleshooting</a> .



---

## **Chapter 8: Maintenance**

---

<b>8.1</b>	<b>General Maintenance Considerations</b> .....	<b>102</b>
<b>8.2</b>	<b>Preventive Maintenance</b> .....	<b>104</b>
<b>8.3</b>	<b>Calibration</b> .....	<b>110</b>
<b>8.4</b>	<b>Recommended Spare Stock</b> .....	<b>111</b>
<b>8.5</b>	<b>Circuit Diagram</b> .....	<b>117</b>
<b>8.6</b>	<b>Troubleshooting</b> .....	<b>118</b>
<b>8.7</b>	<b>Cold Start Procedure</b> .....	<b>123</b>

## 8.1 General Maintenance Considerations

WARNING	High Voltage Hazard
	<p>Power supplies produce high voltage. To avoid the possibility of an electrical shock, you should always power down your system prior to repairing any portion of it.</p>

CAUTION	General Warning
	<p>When performing maintenance on the welder, make sure that no other automated systems are active.</p>

NOTICE	
	<p>There are no customer replaceable components inside the power supply. Have all servicing done by a qualified Branson technician.</p>

NOTICE	
	<p>When returning printed circuit boards, make sure to enclose them in an anti-static package.</p>

NOTICE	
	<p>Connectors may not be keyed and wires may not be color-coded. Therefore, when disconnecting cables and wires, label them so you can reconnect them properly.</p>

## NOTICE



To prevent circuit damage from electrostatic discharge, always service the power supply on a static-dissipative surface, while wearing a properly grounded wrist strap.

## NOTICE



When the battery is worn out, dispose it under the ordinance of each local government.

## 8.2 Preventive Maintenance

The following preventive measures help assure long term operation of your DCX V Power Supply equipment.

### 8.2.1 Periodically Clean the Equipment

NOTICE	
	Use only anti-static vacuum cleaners to prevent damage from electrostatic discharge to your power supply.

Air is continuously drawn into the power supply. Periodically disconnect the unit from power, remove the cover and vacuum out any accumulated dust and debris. Remove material adhering to:

- The fan blades and motor
- Power supply heat sink cooling fins
- Transformers
- Circuit boards
- Cooling intake vents
- Exhaust ports

External covers may be cleaned with a damp sponge or cloth using a solution of mild soap and water. Do not allow cleaning solution to enter the unit.

To prevent rust in areas of high humidity, exposed steel surfaces, may require a very light film of rust preventing oil, such as WD-40®\*.

\* WD-40 is a registered trademark of WD-40 Manufacturing Company.

## 8.2.2 Recondition the Stack (Converter, Booster, and Horn)

NOTICE	
	<p>Never clean the converter-booster-horn stack mating surfaces by using a buffing wheel or by filing.</p>

Welding system components work most efficiently when the converter-booster-horn stack mating surfaces are flat, in solid contact, and free from fretting corrosion. Poor contact between mating surfaces wastes power output, makes tuning difficult, increases noise and heat, and may cause damage to the converter.

For standard 20 kHz and 30 kHz products, a Branson Mylar<sup>®</sup> polyester film washer should be installed between the horn and booster, and horn and converter. Replace the washer if torn or perforated. Stacks using Mylar<sup>®</sup> plastic film washers should be inspected every three months.

Stacks used with silicone grease, as with certain 20 kHz, 30 kHz and all 40 kHz products, should be periodically reconditioned to eliminate fretting corrosion. A stack using silicone grease should be inspected every two weeks for corrosion. When experience is gained for specific stacks, the inspection interval can be adjusted to a longer or shorter period as required.

### Stack Reconditioning Procedure

To recondition stack mating surfaces, take the following steps.

**Table 8.1** Stack Reconditioning Procedure

Step	Action
1	Disassemble the converter-booster-horn stack and wipe the mating surfaces with a clean cloth or paper towel.
2	Examine all mating surfaces. If any mating surface shows corrosion or a hard, dark deposit, recondition it.
3	If necessary, remove the threaded stud from the part.
4	Tape a clean sheet of #400 (or finer) grit emery cloth to a clean, smooth, flat surface (such as a sheet of plate glass), as in <a href="#">Figure 8.1 Reconditioning Stack Mating Surfaces</a> .
5	Place the interface surface on the emery cloth. Grasp the part at the lower end, with your thumb over the spanner-wrench hole, and lap the part in a straight line across the emery cloth. Do not apply downward pressure — the weight of the part alone provides sufficient pressure.
6	Lap the part, two or three times, in the same direction against the emery cloth (See <a href="#">Figure 8.1 Reconditioning Stack Mating Surfaces</a> ).
7	Rotate the part 120 degrees, placing your thumb over the spanner-wrench hole, and repeat the lapping procedure in step 6.

**Table 8.1** Stack Reconditioning Procedure

Step	Action
8	Rotate the part another 120 degrees to the next spanner-wrench hole, and repeat the lapping procedure in step 6.
9	Re-examine the mating surface. If necessary, repeat steps 2-5 until you remove most of the contaminant. Remember, this should not require more than two to three complete rotations for an aluminum horn or booster; a titanium component may require more rotations.
10	<p>Before re-inserting a threaded stud in an aluminum booster or horn:</p> <ul style="list-style-type: none"> <li>Using a file card or wire brush, clean any aluminum bits from the knurled end of the stud</li> <li>Using a clean cloth or towel, clean the threaded hole</li> <li>Examine the knurled end of the stud. If worn, replace the stud. Also, examine the stud and threaded hole for stripped threads</li> </ul> <p><b>NOTICE</b> Threaded studs cannot be reused in titanium horns or boosters. Replace all studs in these components.</p>
11	Assemble and install the stack.

**Figure 8.1** Reconditioning Stack Mating Surfaces

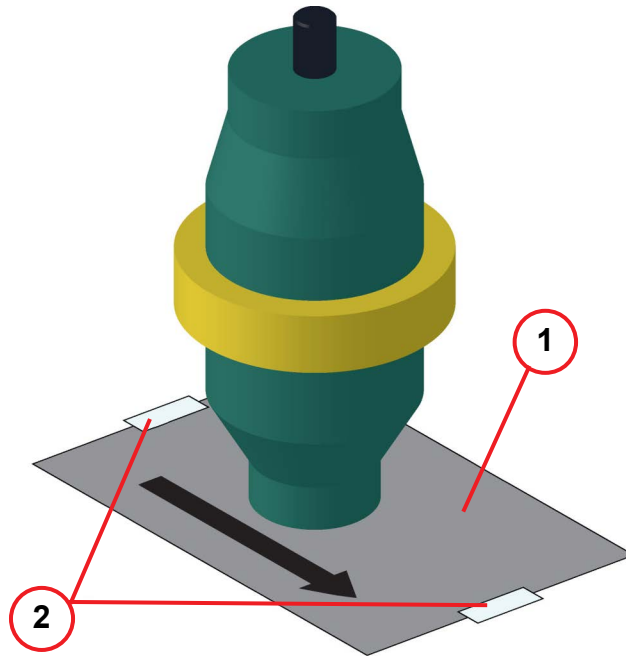

**Table 8.2** Reconditioning Stack Mating Surfaces

Item	Description
1	Tape
2	#400 Emery Cloth

### 8.2.2.1 Stack Torque Values

**Table 8.3** Stack Torque Values

Frequency	Torque
20 kHz	220 in·lb (24.85 N·m)
30 kHz	185 in·lb (21 N·m)
40 kHz	95 in·lb (10.73 N·m)

### For a 20 kHz System

**Table 8.4** Stack Reassembly for a 20 kHz System

Step	Action
1	Clean the mating surfaces of the converter, booster, and horn. Remove any foreign material from the threaded holes.
2	Install the threaded stud into the top of the booster. Torque to 450 in·lb (50.84 N·m). If the stud is dry, apply 1 or 2 drops of a light lubricating oil before installing.
3	Install the threaded stud into the top of the horn. Torque to 450 in·lb (50.84 N·m). If the stud is dry, apply 1 or 2 drops of a light lubricating oil before installing.
4	Install a single Mylar <sup>®</sup> plastic film washer (matching the size of the washer to the stud) to each interface.
5	Assemble the converter to the booster and the booster to the horn.
6	Torque to 220 in·lb (24.85 N·m) at each interface.

## For a 30 kHz System

**Table 8.5** Stack Reassembly for a 30 kHz System

Step	Action
1	Clean the mating surfaces of the converter, booster, and horn. Remove any foreign material from the threaded holes.
2	Install the threaded stud into the top of the booster. Torque to 290 in·lb (32.76 N·m). If the stud is dry, apply 1 or 2 drops of a light lubricating oil before installing.
3	Install the threaded stud into the top of the horn. Torque to 290 in·lb (32.76 N·m). If the stud is dry, apply 1 or 2 drops of a light lubricating oil before installing.
4	Install a single Mylar <sup>®</sup> plastic film washer (matching the size of the washer to the stud) to each interface.
5	Assemble the converter to the booster and the booster to the horn.
6	Torque to 185 in·lb (21 N·m) at each interface.

## For a 40 kHz System

**Table 8.6** Stack Reassembly for a 40 kHz System

Step	Action
1	Clean the mating surfaces of the converter, booster, and horn. Remove any foreign material from the threaded holes.
2	Apply a drop of Loctite <sup>®</sup> * 290 threadlocker (or equivalent) to the studs for the booster and horn.
3	Install the threaded stud into the top of the booster. Torque to 70 in·lb (7.91 N·m). Remove excess Loctite 290 threadlocker from the booster face and let cure for 30 minutes.
4	Install the threaded stud into the top of the horn. Torque to 70 in·lb (7.91 N·m). Remove excess Loctite 290 threadlocker from the horn face and let cure for 30 minutes.
5	Coat each interface surface with a thin film of silicon grease - but do not apply silicon grease to a threaded stud or tip.
6	Torque to 95 in·lb (10.73 N·m) at each interface.

\* Loctite is a registered trademark of Henkel Corporation, U.S.A.

### 8.2.3 Stud Torque Values

**Table 8.7** Stud Torque Values

Used on	Stud Size	Torque	EDP #
20 kHz	1/2 in x 20 x 1-1/4 in	450 in·lb, 50.84 N·m	100-098-370
	1/2 in x 20 x 1-1/2 in		100-098-123
30 kHz	3/8 in x 24 x 1 in	290 in·lb, 32.76 N·m	100-298-170R
40 kHz*	M8 x 1.25	70 in·lb, 7.91 N·m	100-098-790

\* Add a drop of Loctite 290 threadlocker to the stud. Torque and let cure for 30 minutes before using.

### 8.2.4 Routine Component Replacement

The lifetime of certain parts is based on the number of cycles the unit has completed, or on hours of operation. Change cooling fans at 20,000 hours, and filter kits as required.

## 8.3 Calibration

This product does not normally require scheduled calibration. However, if you are operating under any type of regulatory requirements, you may need to calibrate the equipment according to that schedule and set of standards. Contact Branson for details.

## 8.4 Recommended Spare Stock

This section provides lists of replacement parts, system cables, and suggested spares.

### 8.4.1 System Cables

You can order the following cables:

**Table 8.8** DCX V Power Supply System Cables

P/N	Description
100-240-383	Cable, RF 8 ft (2.5 m)
100-240-384	Cable, RF 15 ft (4.5 m)
100-240-385	Cable, RF 25 ft (7.5 m)
100-240-387	Cable, RF right angle 8 ft (2.5 m)
100-240-388	Cable, RF right angle 15 ft (4.5 m)
100-240-389	Cable, RF right angle 25 ft (7.5 m)
100-240-392	Cable, User I/O 25 ft (7.5 m)
200-240-396	Cable Ethernet Cat 5e 7 ft (2.1 m)

## 8.4.2 Suggested Spares

**Table 8.9** Suggested Spares

Description	EDP#	1-4 Units	6-12 Units	14+ Units
Converter	Refer to <a href="#">Table 8.10 Converters Compatible with the DCX V Power Supply</a>	0	1	2
Booster	Refer to <a href="#">Table 8.11 DCX V Power Supply Compatible Boosters</a>	0	1	2
Horn	As Ordered	1	1	2
Studs	Refer to <a href="#">Table 8.12 Other Items used with the DCX V Power Supply</a>	4	6	8
Mylar <sup>®</sup> Plastic Film Washer Kit	Refer to <a href="#">Table 8.12 Other Items used with the DCX V Power Supply</a>	1	1	1

### 8.4.3 Converters Compatible with the DCX V Power Supply

**Table 8.10** Converters Compatible with the DCX V Power Supply

Where used	Model	Connector	Part Number
20 kHz / 1250 W 20 kHz / 2500 W 20 kHz / 4000 W	CR-20S	SHV connector	125-135-115R
	CR-20C	SHV connector with 3 ft (0.9 m) cable	159-135-210R
	CH-20S (932 AH SPL)	SHV connector	159-135-075R
	CH-20C	SHV connector with 3 ft (0.9 m) cable	159-135-211R
	CS-20S	SHV connector	159-135-138R
	CS-20C	SHV connector with 3 ft (0.9 m) cable	159-135-209R
30 kHz / 750 W 30 kHz / 1500 W	CR-30S	SHV connectors	101-135-081R
	CR-30C	SHV connector with 3 ft (0.9 m) cable	159-135-213R
	CH-30S	SHV connector	101-135-071R
	CH-30C	SHV connector with 3 ft (0.9 m) cable	159-135-214R
	CS-30S	SHV connector	159-135-110R
	CS-30C	SHV connector with 3 ft (0.9 m) cable	159-135-212R
40 kHz / 400 W 40 kHz / 800 W	4TP	SHV connector (platen mount)	101-135-068R
	CR-40S (4TH)	SHV connector	101-135-067R
	CR-40C	SHV connector with 3 ft (0.9 m) cable	159-135-215R

## 8.4.4 DCX V Power Supply Compatible Boosters

**Table 8.11** DCX V Power Supply Compatible Boosters

Type of Booster	Description	Part Number
Solid Mount (1/2-20 horn stud) 20 kHz	Titanium, 1:0.6 (Purple)	101-149-095
	Titanium, 1:1 (Green)	101-149-096
	Titanium, 1:1.5 (Gold)	101-149-097
	Titanium, 1:2 (Silver)	101-149-098
	Titanium, 1:2.5 (Black)	101-149-099
Solid Mount (M8 x 1.25 horn stud) 40 kHz	Titanium, 1:0.6 (Purple)	109-041-178
	Titanium, 1:1 (Green)	109-041-177
	Titanium, 1:1.5 (Gold)	109-041-176
	Titanium, 1:2 (Silver)	109-041-175
	Titanium, 1:2.5 (Black)	109-041-174
Standard Series (1/2-20 horn stud) 20 kHz	Aluminum, 1:0.6 (Purple)	101-149-055
	Aluminum, 1:1 (Green)	101-149-051
	Aluminum, 1:1.5 (Gold)	101-149-052
	Aluminum, 1:2 (Silver)	101-149-053
	Titanium, 1:0.6 (Purple)	101-149-060
	Titanium, 1:1 (Green)	101-149-056
	Titanium, 1:1.5 (Gold)	101-149-057
	Titanium, 1:2 (Silver)	101-149-058
Standard Series (3/8-24 horn stud) 30 kHz	Titanium, 1:2.5 (Black)	101-149-103
	Titanium, 1:2 (Silver)	101-149-104
	Titanium, 1:1.5 (Gold)	101-149-105
	Titanium, 1:1 (Green)	101-149-106

**Table 8.11** DCX V Power Supply Compatible Boosters

Type of Booster	Description	Part Number
Standard Series (M8 x 1.25 horn stud) 40 kHz	Aluminum, 1:0.6 (Purple)	101-149-087
	Aluminum, 1:1 (Green)	101-149-079
	Aluminum, 1:1.5 (Gold)	101-149-080
	Aluminum, 1:2 (Silver)	101-149-081R
	Aluminum, 1:2.5 (Black)	101-149-082
	Titanium, 1:1 (Green)	101-149-085
	Titanium, 1:1.5 (Gold)	101-149-086
	Titanium, 1:2 (Silver)	101-149-083
	Titanium, 1:2.5 (Black)	101-149-084

## 8.4.5 Other Items used with the DCX V Power Supply

**Table 8.12** Other Items used with the DCX V Power Supply

Product	Description	Part No.
Silicone grease	For use with 40 kHz systems	101-053-002
Mylar® Plastic Film Washers (for 20 kHz systems)	Kit, 10 each (1/2 in. and 3/8 in.)	100-063-357
	Kit, 150 each (1/2 in.)	100-063-471
	Kit, 150 each (3/8 in.)	100-063-472
Mylar® Plastic Film Washers (for 30 kHz systems)	Kit, 10 each (3/8 in.)	100-063-632
	Kit, 150 each (3/8 in)	100-063-712
Tool Kit	20 kHz (spanner wrench and 10 pc washer kit)	101-063-208R
	30 kHz (spanner wrench and 10 pc washer kit)	101-063-636R
	40 kHz (spanner wrench and silicone grease)	101-063-176R
Spanner wrench	20 kHz	101-118-039
	30 kHz	201-118-033
	40 kHz	201-118-024
Studs	1/2-20 x 1-1/4 (titanium horns)	100-098-370
	1/2-20 x 1-1/2 (aluminum horns, 20 kHz boosters)	100-098-123
	3/8-24 x 1 (30 kHz titanium horns and boosters)	100-298-170R
	M-8 x 1.25 (40 kHz horns and boosters)	100-098-790
Fan Filter*	For small size units (400 W, 750 W, and 800 W)	101-063-936
	For medium size units (1250 W, and 1500 W)	101-063-935
	For large size units (2500 W, and 4000 W)	101-063-934
Connector Block	Detachable connector block	200-029-1108
Top Mounting Plate	Top mounting plate for vertical units.	100-079-462
Bottom Mounting Plate	Bottom mounting plate for vertical units.	100-079-463

\* When using a fan filter on the DCX V Power Supply, the maximum output power must be derated by 10%.

## 8.5 Circuit Diagram

Figure 8.2 Interconnect Diagram, Power Supply

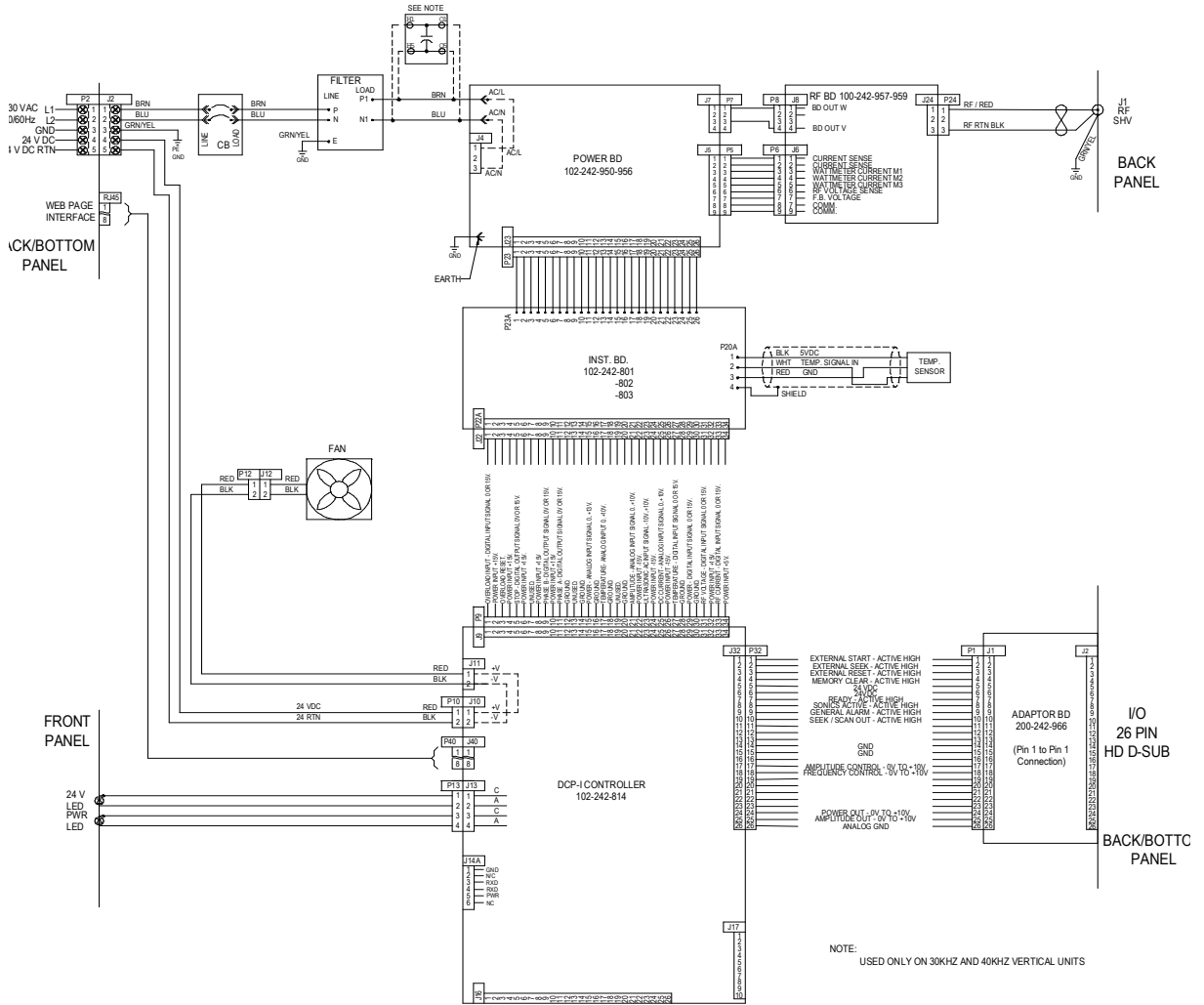

## 8.6 Troubleshooting

If you have a problem operating the DCX V Power Supply, take the following steps:

**Table 8.13** Troubleshooting

Step	Action
1	Make sure the converter-booster-horn stack is properly assembled and installed.
2	For instructions on reconditioning stack component surfaces, refer to <a href="#">8.2.2 Recondition the Stack (Converter, Booster, and Horn)</a> .
3	If you need additional help, refer to <a href="#">1.3 How to Contact Branson</a> .

NOTICE	
	<p>The DCX V Power Supply should be serviced only by qualified technicians using Branson-approved test and repair equipment, repair procedures, and replacement parts. Unauthorized attempts at repair or modification of the power supply will void the warranty.</p>

## 8.6.1 Common Electrical Problems

NOTICE	
	<p>If the circuit breaker fails more than once, this usually indicates that another component has failed. Continue troubleshooting other components.</p>

**Table 8.14** Troubleshooting Common Electrical Problems

Problem	Check	Solution
Main circuit breaker trips when plugging the power supply into an electrical outlet.	Inspect line connection cables.	If failed, replace.
Main circuit breaker trips during weld cycle.	Check current rating of the main circuit breaker.	If failed, replace.
Main circuit breaker fails during power up.	Check main circuit breaker current rating.	If incompatible, replace main circuit breaker.
When touching a component of the weld system, you get a slight electrical shock.	Ensure the Ground cable is connected properly.	N/A
	Inspect the line cables.	If failed, repair or replace.

## 8.6.2 Fan/Power Switch Problems

NOTICE	
	<p>If the circuit breaker fails more than once, this usually indicates that another component has failed. Continue troubleshooting other components.</p>

**Table 8.15** Troubleshooting Fan/Power Switch Problems

Problem	Check	Solution
Fan does not work; 24 V indicator light is off.	External 24 V power supply.	If 24 V are available and unit fails to work, send the unit for repair.
Fan does not work; 24 V and power indicators light is on.		Send unit for repair.
Fan does not work; Power indicator does not light when Power switch is on.	Make sure power supply is plugged into main power.	If power is available and unit fails to work, send the unit for repair.
	Test Power On/Off Switch (power supply circuit breaker).	Send unit for repair.

### 8.6.3 Ultrasonic Power Problems

**Table 8.16** Troubleshooting Ultrasonic Power Problems

Problem	Check	Solution
Ultrasonic power delivered to horn; no indication on bar graph.	Check connector cables, replace if failed.	Replace defective cables.
	Test power supply.	See <a href="#">7.5 Ultrasonics Test Procedure</a> .
No ultrasonic power generated when Test key pressed; no Alarm indicator.	Failed or missing stack.	Replace.
	RF cable unplugged or failed; replace if failed.	Plug in or replace.
	Test power supply (see <a href="#">7.5 Ultrasonics Test Procedure</a> ).	If defective, send unit for repair.
Unable to adjust amplitude using the front panel keypad.	Register setting configured to "External Amplitude Control".	Reset if required, See <a href="#">7.4 Web Page Interface</a> .
Unable to remote control.	User I/O cable.	Repair or replace.
	Customer's switching device.	Test/inspect/repair/replace.

## 8.6.4 Weld Cycle Problems

**Table 8.17** Troubleshooting Weld Cycle Problems

Problem	Check	Solution
Full ultrasonic power not delivered.	Unsuitable horn or booster selection.	Contact Branson Applications Lab
	Plastic part material varies.	
	Mold release lubricant in weld area.	
	Unsuitable joint design.	
	Unsuitable or misaligned part fixture.	
	Amplitude setting.	Adjust if required.
No ultrasonic power passed to horn.	Power supply overheating; check fan and vents.	Replace improperly operating fan. Remove dust and debris.
Alarm indicator illuminates when you press the Test key or during the weld cycle.	Check converter-booster-horn stack interface for fretting corrosion.	See <a href="#">8.2.2 Recondition the Stack (Converter, Booster, and Horn)</a> .
	Check for loose or failed horn converter or booster.	Tighten or replace as needed.
	Check for loose or failed horn or booster stud.	
	Failed RF cable.	Replace if failed.
Excessively warm horn, booster, and converter; occasional overloads.	Check converter-booster-horn stack mating surfaces for fretting corrosion.	See <a href="#">8.2.2 Recondition the Stack (Converter, Booster, and Horn)</a> .
	Be certain proper cooling has been provided.	Replace fan if required.

## 8.7 Cold Start Procedure

The power supply internal memory stores the system default settings and the registers that you set. It also provides temporary storage to support the power supply internal functions. A cold start clears the Amplitude Setting, the user I/O configuration, the IP address, and restores them to original factory defaults. It is not necessary to perform a cold start during normal operation and servicing, but you might find a cold start helpful when:

- You suspect the system is not operating properly
- You want to make a new setup

Some system memory registers, such as Software version, will not be cleared by this Cold Start procedure.

### 8.7.1 Performing a Cold Start

NOTICE	
	<p>Using the Cold Start procedure will erase the current Amplitude Setting, the IP address and some of the Registers that you set. Be sure you have a record of your setup if you want to retain it.</p>

**Table 8.18** Steps to Perform a Cold Start

Step	Action
1	Turn off the power supply.
2	Connect together pins 4 and 10 on the 26-pin User I/O Connector.
3	Turn on the power supply.
4	After the power up sequence ends, turn off the power supply.
5	Disconnect pins 4 and 10 of the 26-pin on User I/O Connector.



---

# **Appendix A: Timing Diagrams**

---

**A.1 Timing Diagrams ..... 126**

## A.1 Timing Diagrams

**Figure A.1** Weld Cycle

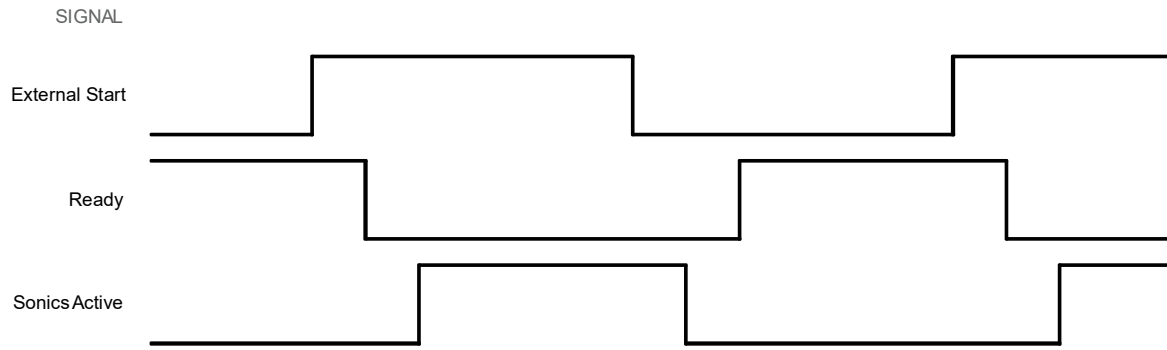

**Figure A.2** Weld Cycle

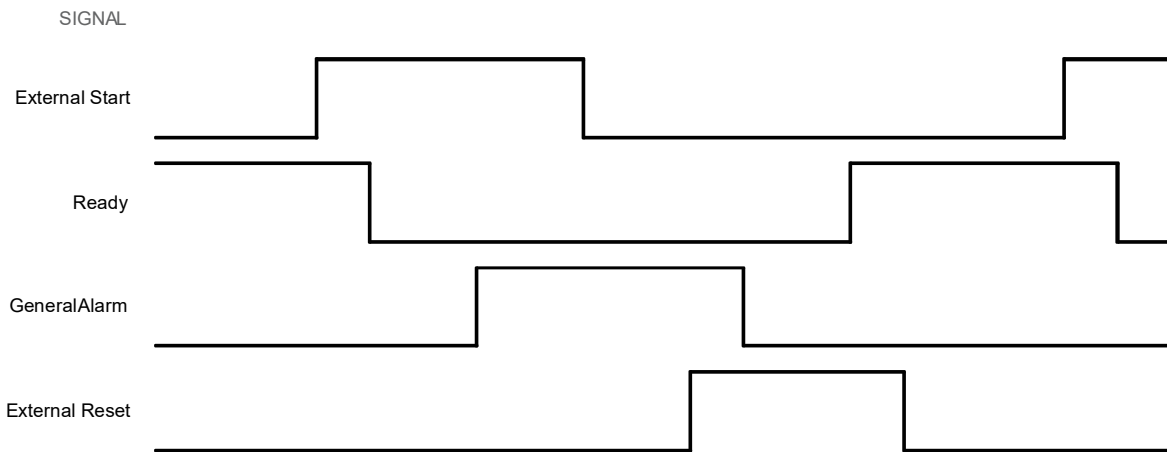

**Figure A.3** Weld Cycle

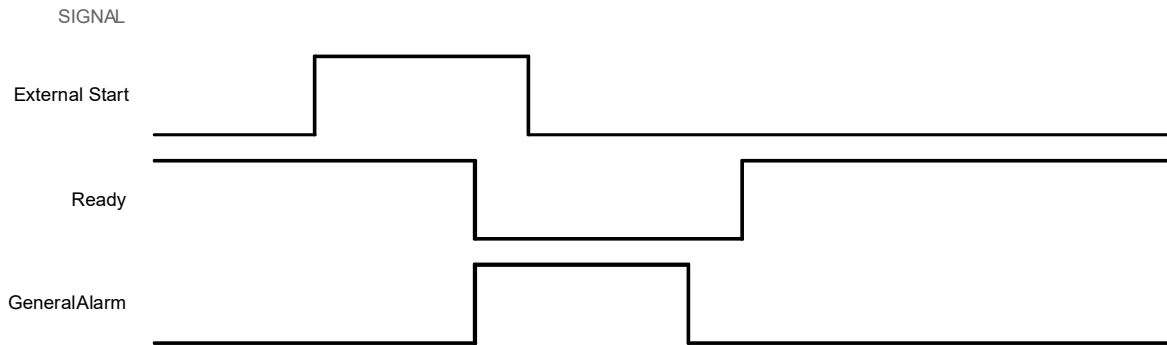

---

## **Appendix B: Signal Diagrams**

---

**B.1 Signal Diagrams ..... 128**

## B.1 Signal Diagrams

Figure B.1 Continuous Mode

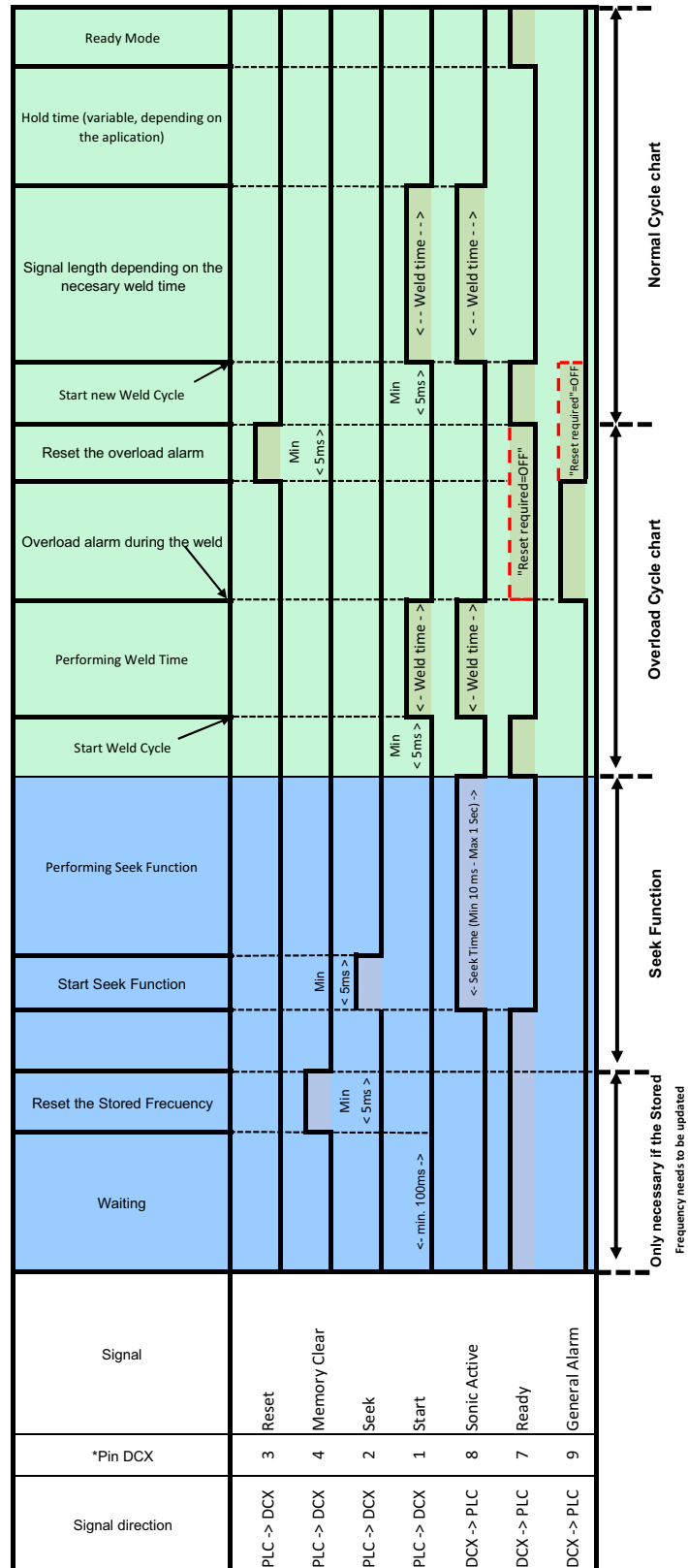

\*Inputs/Outputs are configurable on the User I/O Configuration webpage.

--- If Reset Required is unchecked for Overload in Alarm Webpage interface, Ready signal will be enabled after Start switch is released.

---

## **Appendix C: DCX Alarms**

---

**C.1 DCX Alarms ..... 130**

## C.1 DCX Alarms

The following table details alarms that you can encounter on the DCX S & V Power Supply. These can be seen in the DCX Web Page Alarm Log Tab.

The message on the Alarm Log Tab is shown on the first column. The second column indicates the condition that led to the alarm. The third and fourth columns indicate the possible cause and the corrective action you should take.

**Table C.1** DCX V Alarms

Alarm Description	Alarm Condition	Possible Cause	Corrective Action
Overload - Current	During the weld cycle the current exceeded the limit of the Insulated Gate Bipolar Transistor (IGBT) or power semi-conductor device located in the power supply.	Applications that result in High Impact force or that couple at or during the start of the weld are the normal cause of this overload.	<ul style="list-style-type: none"> <li>Reduce the impact or collision force of the ultrasonic tooling to part.</li> <li>Reduce the force applied at the start of welding.</li> <li>Reduce Amplitude.</li> <li>Increase the power level of the power supply.</li> </ul>
Overload - Power Limit	During the weld cycle the safe operation power limit was exceeded causing the power supply to shut down.	The safe power limit was exceeded. By design the power supply will shut down once a limit of 105% of Peak Power is exceeded.	<ul style="list-style-type: none"> <li>Reduce the force being applied during welding.</li> <li>Reduce Amplitude.</li> <li>Increase available power level of the power supply being used. (If available).</li> </ul>
Overload - Start Frequency Outside Bandwidth	The starting or resonant frequency of the stack (Converter, Booster, Horn) or combination thereof is outside the safe operating band of the frequency of the power supply.	This can range from a crack in any of the acoustic stack components, to poor interface surfaces of the components. The acoustic tooling has a primary resonant frequency outside the range as defined for operation: 20 kHz (19475 to 20474) 30 kHz (29278 to 30797) 40 kHz (38950 to 40949)	<ul style="list-style-type: none"> <li>Perform standard stack maintenance by cleaning the interfaces and reassembling the stack.</li> <li>Remove Horn and test.</li> <li>Remove and replace booster and test.</li> <li>Remove and replace converter and test.</li> <li>If problem persists contact Branson product support and service dept.</li> </ul>

**Table C.1** DCX V Alarms

<b>Alarm Description</b>	<b>Alarm Condition</b>	<b>Possible Cause</b>	<b>Corrective Action</b>
Overload - Temperature	The power supply is operating outside of the recommended safe operating temperature as designed.	The ambient operating temperature of the DCX power supply is + 41° F to + 104° F (+5° C to + 40° C)	<ul style="list-style-type: none"><li>• Be sure the power supply is operating in the stated ambient operating range. It may require additional temperature control to regulate the working environment.</li></ul>



---

## **Appendix D: Manual's Revisions**

---

**D.1 Manual's Revisions ..... 134**

## D.1 Manual's Revisions

Refer to the table below for the appropriate manual revision depending on your Power Supply's manufacturing date.

**Table D.1** Manual's Revisions

Manual's Revisions	Power Supply's Manufacturing Date	
	From	To
00	April 2022	July 2022
01	August 2022	April 2023
02	May 2023	March 2026
03	April 2026	To date

**Figure D.1** Manufacturing date on the Information label



**MODEL: 4.00DCXv20HOR**  
**EDP NO.: 101-132-1838**  
 SERIAL NO.: DJD21064185F



INPUT1:200-240VAC~25A, 50/60Hz 1Ø  
 INPUT 2:24VDC 2.5A  
 MAX PWR: 4000W

MFG. DATE  
June 2021

**MADE IN MEXICO**  **EMERSON**

SERIAL NUMBER: XXXXYMM#####



1. Prefix
2. Year of Manufacture
3. Month of Manufacture
4. Incremental Serial Number

**Figure D.2** Location of the Information label on the back of the DCX V Power Supply Horizontal

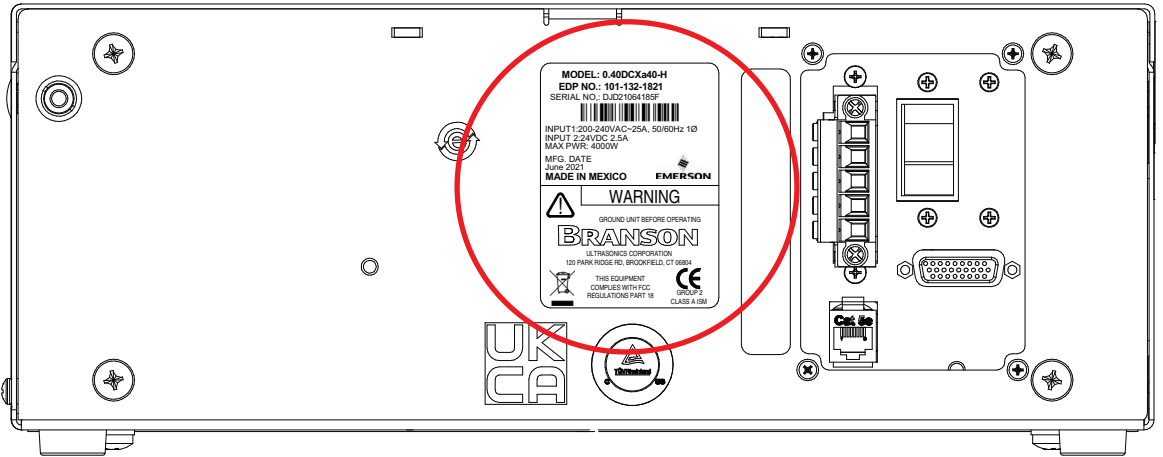

**Figure D.3** Location of the Information label on the top of the DCX V Power Supply Vertical

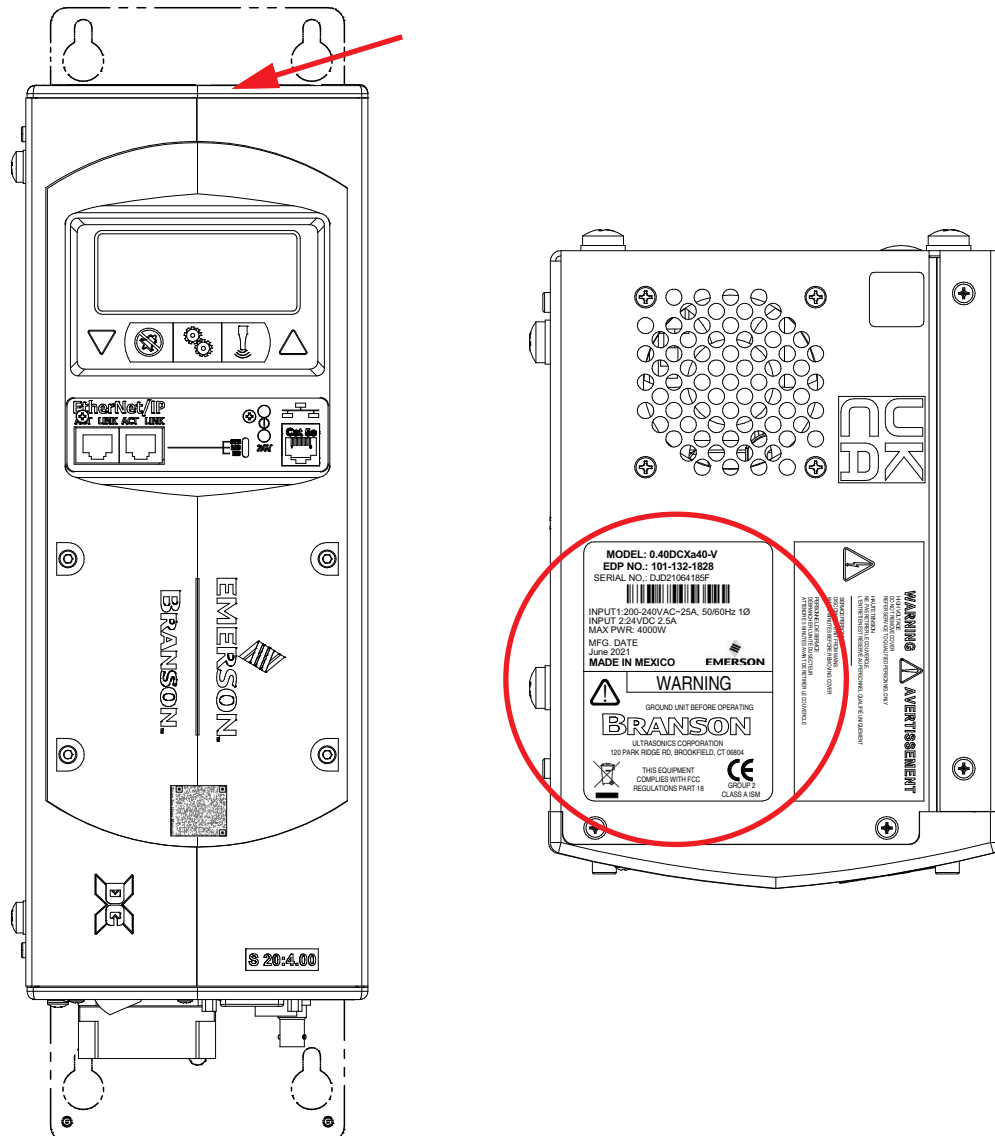



---

# Index

---

## A

- about Installation 42
- actuator 23
- alarm 23
  - configuring 66
  - DCX alarm table 130
  - latching 66
  - modes 66
- amplitude
  - controlling 66
  - definition 23
  - external control 23
  - start ramp 18, 66
- amplitude control 66
- applications 22
- autotune with memory (AT/M) 16

## B

- bar graph 93
- bend radius 50
- booster 19, 23
  - dimensions 78
  - part numbers 114

## C

- cables
  - bend radius 50
  - RF 63
  - user I/O 54
- clamping force 23
- cold start 123
- components
  - functional description 87
- connecting tip to horn 71
- connection
  - input power 64
  - user I/O 54
- connector
  - line 21
  - RF 21
  - user I/O 21
- controls, front panel 20
- converter 19, 23, 87
  - cooling 72
  - dimensions 78
  - part numbers 113
- counters 23

## D

- degating 23
- drop test 26

## E

- electrical input
  - operating voltages 33
- energy director 23
- environmental
  - requirements 48
  - specifications 26
- external
  - amplitude control 23
  - frequency control 23

## F

- fixture 23
- flash 23
- force 23
- forming 23
- frequency 23
  - end of weld store 66
  - external control 23
  - offset 16, 23
  - seek 24
- frequency offset
  - definition 18
  - setup 66

## G

- gain 23
- ground screw 21

## H

- horn 19, 23
  - amplitude 23
  - scan 23
  - signature, definition 18
- humidity 26, 32, 48

## I

- indicators 20
- input
  - connection examples 62
- input power 63, 64
  - plug 64
  - ratings 33
- inputs
  - analog 58
  - digital 57
- insertion 23
- installation 41
  - requirements 43
  - stack 74
  - steps 50

- testing 74
- interface 24
- inventory of small parts 29

## **J**

- joint 24

## **L**

- LCD
  - bar graph 93
  - board 39
- line input
  - connector 21
- line regulation 16
- load regulation 16

## **M**

- maintenance 101
  - general considerations 102
- manual set 16

## **O**

- operating voltages 33
- operation 89
  - principle of 22
- output
  - connection examples 62
- output circuit 39
- output power cable 63
- outputs
  - analog 60
  - digital 58

## **P**

- parameter 24
- parts lists 111
- periodic and preventive maintenance
  - periodically clean the equipment 104
  - recondition the stack 105
  - routine component replacement 111
- power
  - switch 21
- power supply
  - amplitude control 23
  - block diagram 38
  - circuit diagram 117
  - configuring 93
  - connections 21
  - continuous duty max. power 33
  - cycle rate 35
  - default settings (cold start) 123
  - front panel controls 20
  - manual set 15, 16
  - models 14, 15
  - mounting 51

## R

- receiving the equipment 27
- returning equipment 30

## S

- safety
  - cable detect 57
  - general precautions 5
  - maintenance 102
  - symbols, meaning 2
- seek 24
  - definition 18
  - ramp time 66
  - time 66
  - timed 16, 66
- shipping and handling 26
- shock 26
- solid mount boosters 87
- special cable requirements 51
- stack 19, 87
- stack assembly 67
  - 20 kHz 70, 107, 108
  - 30 kHz 70
  - 40 kHz 70
- staking 24
- support 75
- swaging 24
- system requirements, web page interface 93

## T

- technical specifications 31, 77
- temperature
  - ambient operating temperature 32, 48
  - shipping and storage 26, 32
- thermoplastic 24
- thermoset 24
- timed seek 16
- troubleshooting 118
  - electrical problems 119
  - fan/power switch problems 120
  - ultrasonic power 121
  - weld cycle problems 122

## U

- ultrasonic power 24
- ultrasonic stack 87
- ultrasonic welding 24
- unpacking 28

## V

- vibration 26

## W

- web page interface 16, 18, 93
  - point-to-point connection

Windows 10 or Windows 11 93  
weld system 24  
  applications 22  
welding systems 22

