



**EMERSON**<sup>™</sup>

Original Instructions  
4000844 - REV. 02



# DCX S

## Power Supply

# Operating Manual

**Branson Ultrasonics Corp.**  
120 Park Ridge Road  
Brookfield, CT 06804  
(203) 796-0400  
<http://www.bransonultrasonics.com>

**BRANSON**

## Manual Change Information

At Branson, we strive to maintain our position as the leader in ultrasonics plastics joining, metal welding, cleaning and related technologies by continually improving our circuits and components in our equipment. These improvements are incorporated as soon as they are developed and thoroughly tested.

Information concerning any improvements will be added to the appropriate technical documentation at its next revision and printing. Therefore, when requesting service assistance for specific units, note the Revision information found on this document, and refer to the printing date which appears on this page.

## Copyright and Trademark Notice

Copyright © 2026 Branson Ultrasonics Corporation.  
All rights reserved.

Contents of this publication may not be reproduced in any form without the written permission of Branson Ultrasonics Corporation.

Mylar is a registered trademark of DuPont Teijin Films.

Loctite is a registered trademark of Loctite Corporation, Newington, CT.

WD-40 is a registered trademark of WD-40 Manufacturing Company.

Windows 10, Windows 11, and Microsoft Edge are registered trademarks of Microsoft Corporation.

Google Chrome is a trademark of Google LLC.

Other trademarks and service marks mentioned herein are held by their respective owners.

## Foreword

Congratulations on your choice of a Branson Ultrasonics Corporation system!

The Branson DCX S-Series system is process equipment for the joining of plastic parts using ultrasonic energy. It is the newest generation of product using this sophisticated technology for a variety of customer applications. This Operating Manual is part of the documentation set for this system, and should be kept with the equipment.

Thank you for choosing Branson!

## Introduction

This manual is arranged into several structured chapters which will help you find the information you may need to know to safely handle, install, set up, program, operate, and/or maintain this product. Please refer to the [Table of Contents](#) and/or the [Index](#) of this manual to find the information you may be looking for. In the event you require additional assistance or information, please contact our Product Support department (see [1.4 How to Contact Branson](#) for information on how to contact them) or your local Branson representative.



---

# Table of Contents

---

## Chapter 1: Safety and Support

1.1	Safety Requirements and Warnings . . . . .	2
1.2	General Precautions . . . . .	5
1.3	Warranty Statement, Disclaimer . . . . .	8
1.4	How to Contact Branson . . . . .	10
1.5	Returning Equipment for Repair . . . . .	11
1.6	Obtaining Replacement Parts . . . . .	14

## Chapter 2: Introduction to the DCX S 120V P/S

2.1	Models Covered . . . . .	16
2.2	Relation to other Branson Models . . . . .	18
2.3	Compatibility with other Branson Products . . . . .	19
2.4	Features . . . . .	20
2.5	Controls and Indicators . . . . .	22
2.6	Welding Systems . . . . .	25
2.7	Glossary . . . . .	26

## Chapter 3: Delivery and Handling

3.1	Shipping and Handling . . . . .	30
3.2	Receiving . . . . .	31
3.3	Unpacking the Power Supply . . . . .	32
3.4	Take Inventory of Small Parts . . . . .	33
3.5	Returning Equipment . . . . .	34

## Chapter 4: Installation and Setup

4.1	About Installation . . . . .	36
4.2	Installation Requirements . . . . .	37
4.3	Installation Steps . . . . .	39
4.4	Power Supply Configuration . . . . .	50
4.5	Assembling the Acoustic Stack . . . . .	51
4.6	Converter Cooling . . . . .	55
4.7	Testing the Installation . . . . .	56
4.8	Still Need Help? . . . . .	57

## Chapter 5: Technical Specifications

5.1	Technical Specifications . . . . .	60
5.2	Physical Description . . . . .	62
5.3	Standard Modules and Components . . . . .	63

## Chapter 6: Operation

6.1	Activating Ultrasonic Power . . . . .	74
6.2	Setting the Amplitude . . . . .	75
6.3	Resetting the Power Supply Alarms . . . . .	77
6.4	Configuring the Power Supply Registers . . . . .	78
6.5	LCD Bar Graph . . . . .	81
6.6	Web Page Interface . . . . .	84
6.7	Ultrasonics Test Procedure . . . . .	88

## **Chapter 7: Maintenance**

7.1	General Maintenance Considerations . . . . .	94
7.2	DCX S-Series Preventive Maintenance . . . . .	95
7.3	Calibration . . . . .	100
7.4	Recommended Spare Stock . . . . .	101
7.5	Circuit Diagram . . . . .	105
7.6	Troubleshooting . . . . .	106
7.7	Cold Start Procedure . . . . .	110

## **Appendix A: Signal Diagrams**

A.1	Signal Diagrams . . . . .	112
-----	---------------------------	-----

## **Appendix B: Manual's Revisions**

B.1	Manual's Revisions . . . . .	114
-----	------------------------------	-----

# List Of Figures

## Chapter 1: Safety and Support

Figure 1.1 Safety-related Labels found on the DCX S-Series 120V Power Supply . . . . . 4

## Chapter 2: Introduction to the DCX S 120V P/S

Figure 2.1 The DCX S 120V Power Supply . . . . . 16

Figure 2.2 DCX S-Series Front Panel Controls and Indicators . . . . . 22

Figure 2.3 LCD Description . . . . . 23

Figure 2.4 DCX S-Series Back Panel . . . . . 24

## Chapter 3: Delivery and Handling

## Chapter 4: Installation and Setup

Figure 4.1 DCX S 120V Power Supply Dimensional Drawing . . . . . 37

Figure 4.2 LCD Viewing Angle . . . . . 40

Figure 4.3 DCX S 120V Power Supply Connections . . . . . 41

Figure 4.4 User I/O Cable Identification and Wire Color Diagram . . . . . 42

Figure 4.5 Typical Digital I/O Wiring Examples . . . . . 47

Figure 4.6 Typical Analog I/O Wiring Examples . . . . . 47

Figure 4.7 RF Cable Connection . . . . . 48

Figure 4.8 Assembling the Acoustic Stack . . . . . 51

Figure 4.9 Connecting Tip to Horn . . . . . 54

## Chapter 5: Technical Specifications

Figure 5.1 System Block Diagram . . . . . 63

Figure 5.2 20 kHz typical Converter Dimensions . . . . . 65

Figure 5.3 20 kHz CH-20S Converter Dimensions . . . . . 66

Figure 5.4 20 kHz Booster Dimensions . . . . . 67

Figure 5.5 20 kHz Converter/Booster/Horn, Typical Dimensions . . . . . 68

Figure 5.6 40 kHz 4TJ Converter Dimensions . . . . . 69

Figure 5.7 40 kHz Booster Dimensions . . . . . 70

Figure 5.8 40 kHz Converter/Booster/Horn, Typical Dimensions . . . . . 71

## Chapter 6: Operation

Figure 6.1 LCD at Power Up . . . . . 75

Figure 6.2 LCD when in External Amplitude Control Mode . . . . . 76

Figure 6.3 Power Bar Graph Interpretation Examples . . . . . 81

Figure 6.4 Frequency Bar Graph Interpretation Examples . . . . . 83

Figure 6.5 Test Connections . . . . . 91

## Chapter 7: Maintenance

Figure 7.1 Reconditioning Stack Mating Surfaces . . . . . 97

Figure 7.2 Interconnect Diagram, Power Supply . . . . . 105

## Appendix A: Signal Diagrams

Figure A.1 Continuous Mode . . . . . 112

## **Appendix B: Manual's Revisions**

Figure B.1 Manufacturing date on the Information label . . . . .	114
Figure B.2 Location of the Information label on the back of the DCX S Power Supply Horizontal	115
Figure B.3 Location of the Information label on the top of the DCX S Power Supply Vertical . . .	115

# List Of Tables

## Chapter 1: Safety and Support

Table 1.1	Warranty Period	8
Table 1.2	Branson Contacts	12

## Chapter 2: Introduction to the DCX S 120V P/S

Table 2.1	Models Covered in this Manual	16
Table 2.2	Power Supply Compatibility with Branson Converters	19
Table 2.3	DCX S-Series Front Panel Controls and Indicators	22
Table 2.4	LCD Description	23
Table 2.5	Connections to the DCX S-Series 120V Power Supply	24

## Chapter 3: Delivery and Handling

Table 3.1	Shipping Specifications	30
Table 3.2	Power Supply Inspection Procedure	31
Table 3.3	Unpacking Procedure	32
Table 3.4	Small Parts Included: Power Supply Assemblies	33
Table 3.5	DCX S-Series	33

## Chapter 4: Installation and Setup

Table 4.1	DCX S Power Supply Dimensional Drawing	37
Table 4.2	Environmental Requirements	38
Table 4.3	Input Current and Circuit Breaker Specifications	38
Table 4.4	DCX S Electrical Connections	41
Table 4.5	User I/O Cable Identification and Wire Color Diagram	42
Table 4.6	User I/O Cable Pin assignments	43
Table 4.7	Available Digital Input Functions	43
Table 4.8	Available Digital Output Functions	44
Table 4.9	Available Analog Input Functions	45
Table 4.10	Available Analog Output Functions	45
Table 4.11	Default User I/O Connector Pin Assignments	46
Table 4.12	RF Cable Connection	48
Table 4.13	Input Power Connection Procedure	49
Table 4.14	Assembling the Acoustic Stack	52
Table 4.15	Stack Torque Values	52
Table 4.16	Tools	52
Table 4.17	Acoustic Stack Assembly Procedure for 20 kHz	53
Table 4.18	Acoustic Stack Assembly Procedure for 40 kHz	53
Table 4.19	Tip to Horn Torque Values	54
Table 4.20	Continuous Duty Maximum Power & Full Power Duty Cycle	55
Table 4.21	Converter Cooling Procedure	55

## Chapter 5: Technical Specifications

Table 5.1	Environmental Specifications	60
Table 5.2	Electrical Input Operating Voltages	61
Table 5.3	Input Current and Circuit Breaker Specifications	61
Table 5.4	Continuous Duty Maximum Power	61
Table 5.5	Dimensions and Weights of DCX S-Series 120V Power Supplies	62
Table 5.6	20 kHz Converter	65
Table 5.7	20 kHz CH-20S Converter	66

Table 5.8	20 kHz Booster . . . . .	67
Table 5.9	20 kHz Stack . . . . .	68
Table 5.10	40 kHz 4TJ Converter . . . . .	69
Table 5.11	40 kHz Booster . . . . .	70
Table 5.12	40 kHz Stack . . . . .	71

## Chapter 6: Operation

Table 6.1	Setting the Amplitude Using the Front Panel Controls . . . . .	75
Table 6.2	Resetting the DCX S Power Supply . . . . .	77
Table 6.3	Steps to configure the Power Supply Registers . . . . .	78
Table 6.4	Power Supply Registers . . . . .	79
Table 6.5	Frequency Bar-Graph Interpretation - 20 kHz (50 Hz Segment) . . . . .	82
Table 6.6	Frequency Bar-Graph Interpretation - 40 kHz (100 Hz/Segment) . . . . .	82
Table 6.7	Power Supply Ultrasonic Test Procedure (Front Panel) . . . . .	88
Table 6.8	Power Supply Ultrasonic Test Procedure (User I/O) . . . . .	89
Table 6.9	Test Connections . . . . .	91
Table 6.10	Power Supply Ultrasonic Test Procedure . . . . .	91

## Chapter 7: Maintenance

Table 7.1	Stack Reconditioning Procedure . . . . .	96
Table 7.2	Reconditioning Stack . . . . .	97
Table 7.3	Stack Torque Values . . . . .	97
Table 7.4	Stack Reassembly Steps for a 20 kHz System . . . . .	98
Table 7.5	Stack Reassembly Steps for a 40 kHz System . . . . .	98
Table 7.6	Stud Torque Values . . . . .	99
Table 7.7	DCX S-Series System Cables . . . . .	101
Table 7.8	Suggested Spares . . . . .	101
Table 7.9	Converters Compatible with the DCX S-Series 120V Power Supply . . . . .	102
Table 7.10	DCX S-Series Compatible Boosters . . . . .	102
Table 7.11	Other Items used with the DCX-S Series Power Supply . . . . .	103
Table 7.12	Troubleshooting . . . . .	106
Table 7.13	Troubleshooting Common Electrical Problems . . . . .	106
Table 7.14	Troubleshooting Fan/Power Switch Problem . . . . .	107
Table 7.15	Troubleshooting Ultrasonic Power Problems . . . . .	107
Table 7.16	Troubleshooting Weld Cycle Problems . . . . .	108
Table 7.17	Steps to Perform a Cold Start . . . . .	110

## Appendix A: Signal Diagrams

## Appendix B: Manual's Revisions

Table B.1	Manual's Revisions . . . . .	114
-----------	------------------------------	-----

---

# Chapter 1: Safety and Support

---





<b>1.1</b>	<b>Safety Requirements and Warnings</b> . . . . .	<b>2</b>
<b>1.2</b>	<b>General Precautions</b> . . . . .	<b>5</b>
<b>1.3</b>	<b>Warranty Statement, Disclaimer</b> . . . . .	<b>8</b>
<b>1.4</b>	<b>How to Contact Branson</b> . . . . .	<b>10</b>
<b>1.5</b>	<b>Returning Equipment for Repair</b> . . . . .	<b>11</b>
<b>1.6</b>	<b>Obtaining Replacement Parts</b> . . . . .	<b>14</b>



## 1.1 Safety Requirements and Warnings

This chapter contains an explanation of the different Safety Notice symbols and icons found both in this manual and on the product itself and provides additional safety information for ultrasonic welding. This chapter also describes how to contact Branson for assistance.

### 1.1.1 Symbols Found in this Manual

These symbols used throughout this manual warrant special attention:

<b>WARNING</b>	<b>Indicates a possible danger</b>
	If these risks are not avoided, death or severe injury might result.
<b>WARNING</b>	<b>High Voltage Hazard</b>
	High voltage. Turn power off before servicing.
<b>WARNING</b>	<b>Corrosive Material Hazard</b>
	Corrosive material. Avoid contact with eyes and skin. Wear proper protection.
<b>CAUTION</b>	<b>Indicates a possible danger</b>
	If these risks are not avoided, slight or minor injury might result.

CAUTION	Loud Noise Hazard
	Loud noise hazard. Ear protection must be worn.
CAUTION	Heavy Object
	Heavy object. To avoid muscle strain or back injury, use lifting aids and proper lifting techniques.
NOTICE	Indicates a possible damaging situation
	<p>If this situation is not avoided, the system or something in its vicinity might get damaged.</p> <p>Application types and other important or useful information are emphasized.</p>

## 1.1.2 Symbols Found on the Product

The DCX S-Series 120V Power Supply has several safety-related labels on it to indicate the presence of hazardous voltages inside the unit.

**Figure 1.1** Safety-related Labels found on the DCX S-Series 120V Power Supply





## 1.2 General Precautions

Take the following precautions before servicing the power supply:

- Be sure the power switch is in the off position before making any electrical connections
- To prevent the possibility of an electrical shock, always plug the power supply into a grounded power source
- To prevent the possibility of an electrical shock, ground the power supply by securing an 8 gage grounded conductor to the ground screw located next to the air outlet
- Power supplies produce high voltage. Before working on the power supply assembly, do the following:
  - Turn off the power supply;
  - Unplug main power; and
  - Allow at least 5 minutes for capacitors to discharge
- High voltage is present in the power supply. Do not operate with the cover removed
- High line voltages exist in the ultrasonic power supply assembly. Common points are tied to circuit reference, not chassis ground. Therefore, use only non-grounded, battery-powered multimeters when testing the power supply assembly. Using other types of test equipment can present a shock hazard
- Keep hands from under the horn. Down force (pressure) and ultrasonic vibrations can cause injury
- Do not cycle the welding system if either the RF cable or converter is disconnected
- When using larger horns, avoid situations where fingers could be pinched between the horn and the fixture

CAUTION	General Warning
	<p>Sound level and frequency of the noise emitted during the ultrasonic assembly process may depend upon <b>a.</b> type of application, <b>b.</b> size, shape and composition of the material being assembled, <b>c.</b> shape and material of the holding fixture, <b>d.</b> welder setup parameters and <b>e.</b> tool design. Some parts vibrate at an audible frequency during the process. Some or all of these factors may result in an uncomfortable noise being emitted during the process. In such cases operators may need to be provided with personal protective equipment. See 29 CFR (Code of Federal Regulations) 1910.95 Occupational Noise Exposure.</p>

NOTICE	
	<p>When the battery is worn out, dispose it under the ordinance of each local government.</p>

WARNING	Corrosive Material Hazard
	<p>First aid measures (in case of electrolyte leakage from the battery):</p> <p><b>Eye Contact:</b> Flush the eyes with plenty of clean water for at least 15 minutes immediately, without rubbing. Get immediate medical treatment. If appropriate procedures are not taken, this may cause eye injury.</p> <p><b>Skin Contact:</b> Wash the affected area under tepid running water using a mild soap. If appropriate procedures are not taken, this may cause sores on the skin. Get medical attention if irritation develops or persists.</p> <p><b>Inhalation:</b> Remove to fresh air immediately. Get medical treatment immediately.</p>

### 1.2.1 Intended Use of the System

The DCX S-Series Power Supply and components are designed to be used as part of an ultrasonic welding system. These are designed for a wide variety of welding or processing applications.

### 1.2.2 Emissions

When being processed, certain plastic materials can emit toxic fumes, gases or other emissions that can be hazardous to the operator's health. Where such materials are processed, proper ventilation of the workstation is required. Check your materials suppliers for recommended protection when processing their materials.

CAUTION	General Warning
	<p>Processing of many materials, such as PVC, can be hazardous to an operator's health and could cause corrosion/damage to the equipment. Use proper ventilation and take protective measures.</p>

### 1.2.3 Setting up the Workplace

Measures for setting up a workplace for safe operation of the ultrasonic welder are outlined in [Chapter 4: Installation and Setup](#).

### 1.2.4 Regulatory Compliance

The Branson DCX S-Series 120V Power Supply and components are designed to be in compliance with the following U.S. regulatory and agency guidelines and standards:

- ANSI Z535.1 Safety Color Code
- ANSI Z535.3 Criteria for Safety Symbols
- ANSI Z535.4 Product Safety Signs and Labels
- NFPA 70 National Electrical Code Article 670 Industrial Machinery
- NFPA 79 Electrical Standard for Industrial Machinery
- 29 CFR 1910.212 OSHA General Requirements for all machines
- 47 CFR Part 18 Federal Communication Commission
- UL 61010-1 Safety Requirements for Electrical Equipment

## 1.3 Warranty Statement, Disclaimer

The following excerpts from the “Terms and Conditions of Sale” (found on the back of your Invoice) are essential guidelines for the product Warranty issued with your Branson ultrasonic welding components. The items listed in this section specifically address issues involving the delivery, shipment, and warranty period provided. If you have any questions, please refer to the back of the Invoice included with your system, which lists all of the Terms and Conditions of Sale, or contact your Branson representative.

### TERMS AND CONDITIONS OF SALE

Branson Ultrasonics Corporation is herein referred to as the “Seller” and the customer or person or entity purchasing products (“Products”) from Seller is referred to as the “Buyer”. Buyer’s acceptance of the Products will manifest Buyer’s assent to these Terms and Conditions.

### ULTRASONIC JOINING EQUIPMENT NORTH AMERICAN WARRANTY POLICY

Each product manufactured by Branson is guaranteed to be free from *defects in material and workmanship* for a period of time specified in [Table 1.1 Warranty Period](#) from the date of shipment.

**Table 1.1** Warranty Period

Product	Warranty Period
Power Supplies	36 months
Accessories	36 months
Converters	36 months (limited to <i>one-time</i> replacement)
Non-Branson equipment (i.e. printers, etc.)	warranted by the manufacturer
Horns	12 months (limited to <i>one-time</i> replacement)
Boosters	36 months
Handheld devices	12 months
Rental Equipment	Same as purchased equipment
Specials and products with EDP prefix 159-xxx-xxx	12 months
Specials and products with EDP prefix 125-xxx-xxx	12 months

**The warranty does *not* apply to:**

- Any product which has been subject to misuse, misapplication, neglect (including without limitation inadequate maintenance), accident or improper installation, modification or adjustment
- Applications requiring metal-to-metal contact when the ultrasonic exposure time exceeds 1.5 seconds
- Any product exposed to adverse environments, improper repair or repairs using non-Branson methods or material
- Non-Branson equipment (i.e., horns, boosters, converters) or improperly tuned horns

- Set-up/installation of equipment and software updates

### **Warranty Service covers the following:**

Repair service at Branson's main repair facility or a regional office

- Includes parts and labor performed at Branson authorized repair facilities. The customer must return the equipment properly packed with all shipping charges prepaid

Repair service at the customer site

- Includes parts and labor at the customer site performed by a Branson technician. The customer is responsible for all travel-related charges

### **Module trade-in:**

- Includes serialized components for work performed by the customer. The customer orders the replacement components from the Parts Store and issues a P.O. When the failed components are returned to Branson the warranty status is verified and a credit is issued. The customer is responsible for all shipping charges

### **Additional Warranty Notes**

- Components replaced during in-warranty repair carry the remainder of the original warranty
- Serialized assemblies replaced during the repair of out-of-warranty equipment are warranted for a period of 12 months
- Travel charges for Branson service personnel will be waived on service calls performed within 30 days of invoice date
- Non-serialized parts replaced during the repair of out-of-warranty equipment are warranted for 3 months
- Trade in allowance: Branson out-of-warranty serialized components are entitled to a 25% trade in allowance regardless of age or condition, however, converters must be less than 5 years old to qualify for the trade in

If you have any questions concerning the warranty coverage (including coverage outside of North America), please contact your Branson representative or Branson Customer Support.

## 1.4 How to Contact Branson

Branson is here to help you. We appreciate your business and are interested in helping you successfully use our products. To contact Branson for help, use the following telephone numbers, or contact the field office nearest you (business hours from 8 a.m. to 4 p.m. Central and Eastern Time Zones):

- **North American Headquarters** (all Departments): (203) 796-0400
- **Parts Store (direct number)**: (877) 330-0406
- **Repair department**: (877)-330-0405
- **For emergency after-hours service (5 p.m. – 8 a.m. EST)**: (203) 796-0500 (US phone numbers only).

Tell the operator which product you have and which person or department you need (Section [1.5.3 Departments to Contact](#), [Table 1.2 Branson Contacts](#) below). If after hours, please leave a voice message with your name and return telephone number.

### 1.4.1 Before Calling Branson for Assistance

This manual provides information for troubleshooting and resolving problems that could occur with the equipment (see [Chapter 7](#)). If you still require assistance, Branson Product Support is here to help you. To help identify the problem, use the following questionnaire which lists the common questions you will be asked when you contact the Product Support department.

**Before calling, determine the following information:**

1. Your company name and location.
2. Your return telephone number.
3. Have your manual with you. If troubleshooting a problem, refer to [Chapter 7](#).
4. Know your equipment model and serial numbers (found on a gray data label on the units). Information about the horn (part number, gain, etc.) or other tooling may be etched into the tooling. Software- or firmware-based systems may provide a BOS or software version number, which may be required.
5. What tooling (horn) and booster are being used?
6. What are the setup parameters and mode?
7. Is your equipment in an automated system? If so, what is supplying the "start" signal?
8. Describe the problem; provide as much detail as possible. For example, is the problem intermittent? How often does it occur? How long before it occurs if you are just powering up? If an error is occurring, which error (give error number or name)?
9. List the steps you have already taken.
10. What is your application, including the materials being processed?
11. Have a list of service or spare parts you have on hand (tips, horns, etc.)
12. Notes: \_\_\_\_\_  
\_\_\_\_\_  
\_\_\_\_\_  
\_\_\_\_\_

## 1.5 Returning Equipment for Repair

Before sending equipment for repair, provide as much information with the equipment to help determine the problem with the system. Use the following page to record necessary information.

NOTICE	
	<p>To return equipment to Branson, you must first obtain an <b>RG number</b> from a Branson representative, or the shipment may be delayed or refused.</p>

If you are returning equipment to Branson for repair, you must first call the Repair department to obtain a Returned Goods Authorization (RG number). (If you request it, the repair department will fax a Returned Goods Authorization form to fill out and return with your equipment.)

Branson Repair Department, C/O Zuniga Logistics, LTD  
 12013 Sara Road, Killam Industrial Park  
 Laredo, Texas 78045 U.S.A.  
 direct telephone number: (877) 330-0405  
 fax number: (877) 330-0404

- Provide as much information as possible that will help identify the need for repair
- Carefully pack the equipment in original packing cartons
- Clearly label all shipping cartons with the RGA number on the outside of cartons as well as on your packing slip, along with the reason for return
- Return general repairs by any convenient method. Send priority repairs by air freight
- You must prepay the transportation charges FOB Laredo, Texas, U.S.A.

### 1.5.1 Get an RGA Number

**RG#** \_\_\_\_\_

If you are returning equipment to Branson, please call the Repair Department to obtain a Returned Goods Authorization (RGA) number. (At your request, the Repair Department will fax an RGA form to fill out and return with the equipment.)

### 1.5.2 Record information about the Problem

Before sending equipment for repair, record the following information and send a copy of it with the equipment. This will greatly increase Branson’s ability to address the problem.

1. Describe the problem; provide as much detail as possible.  
 For example, is the problem intermittent? How often does it occur? How long before it occurs after powering up?

---



---



---



---

2. Is your equipment in an automated system? NO / YES

3. If the problem is with an external signal, which signal? \_\_\_\_\_  
If known, include plug/pin # (e.g., P29, pin #3) for that signal: \_\_\_\_\_
4. What are the Weld Parameters?

---



---

5. What is your application? (Type of weld, plastic material, etc.)

---



---

6. Name and phone number of the person most familiar with the problem:

---



---

7. Contact the Branson office prior to shipping the equipment.

8. For equipment not covered by warranty, to avoid delay, include a Purchase Order.

Send a copy of this page with the equipment being returned for repair.

### 1.5.3 Departments to Contact

Call your local Branson Representative, or contact Branson by calling and asking for the appropriate department, as indicated in [Table 1.2 Branson Contacts](#) below.

**Table 1.2** Branson Contacts

What you need help with or information about	Whom to Call	At this Phone Number
Information about new welding systems or components	Your local Branson Rep or Branson Customer Service	203-796-0400 Ext 384
Application and setup questions on the welding system	Welding Applications Lab	203-796-0400 Ext 368
Application assistance on the horns and tooling	ATG Lab	203-796-0400 Ext 495
Technical questions about the welding system	Welding Product Support	203-796-0400 Ext 355, 551
Technical questions about horns and tooling	ATG Lab	203-796-0400 Ext 495
Ordering new parts	Parts Store	877-330-0406
RGA's, request for repair, status of a repair	Welding Repair Department	877-330-0405
System automation/hookup information	Product Support	203-796-0400 Ext 355, 551

My Local Branson Representative's name is:

---

I can reach this representative at:

---

## 1.5.4 Pack and Ship the Equipment

1. Carefully pack the system in original packing material to avoid shipping damage. Plainly show the RGA number on the outside of cartons as well as inside the carton along with the reason for return. Make a list of all components packed in the box. **KEEP YOUR MANUAL.**
2. Return general repairs by any convenient method. Send priority repairs by air freight. Prepay the transportation charges FOB the repair site.

NOTICE	
	Items that are sent Freight Collect will be refused.

## 1.6 Obtaining Replacement Parts

You can reach Branson Parts Store at the following telephone numbers:

Branson Part Store

direct telephone number: 877-330-0406

fax number: 877-330-0404

Many parts can be shipped the same day if ordered before 2:30 p.m., Eastern time.

A parts list is found in [Chapter 7](#) of this manual, listing descriptions and EDP part numbers. If you need replacement parts, coordinate the following with your purchasing agent:

- Purchase order number
- 'Ship to' information
- 'Bill to' information
- Shipping instructions (air freight, truck, etc.)
- Any special instructions (for example, "Hold at the airport and call"). Be sure to give a name and phone number

---

## **Chapter 2: Introduction to the DCX S 120V P/S**

---

<b>2.1 Models Covered</b> .....	<b>16</b>
<b>2.2 Relation to other Branson Models</b> .....	<b>18</b>
<b>2.3 Compatibility with other Branson Products</b> .....	<b>19</b>
<b>2.4 Features</b> .....	<b>20</b>
<b>2.5 Controls and Indicators</b> .....	<b>22</b>
<b>2.6 Welding Systems</b> .....	<b>25</b>
<b>2.7 Glossary</b> .....	<b>26</b>

## 2.1 Models Covered

This manual covers all models of the DCX S-Series 120V Power Supply.

**Table 2.1** Models Covered in this Manual

Frequency	Power	EDP
20 kHz	1250 W	159-132-2004
40 kHz	400 W	159-132-2006
	800 W	159-132-2007

### 2.1.1 Overview of these Models

**Figure 2.1** The DCX S 120V Power Supply



The DCX S 120V Power Supply generates ultrasonic energy through an ultrasonic converter for welding plastics. Several models are available, depending on the desired frequency (for example, 20 kHz), and the desired power range (for example, 1.25 kW). The power supply also contains a microprocessor-based controller module that provides for control and monitoring of welding operations.

The power supply provides the following features:

- **End of Weld Store** — Allows the power supply to track and store the frequency of the last weld
- **Timed Seek** — Tracks and starts the stack on the correct frequency. It does this by running the horn at a low-level amplitude (10%) to find and lock on to the stack operating frequency. Seeks are timed from the moment sonics was last activated
- **Line Regulation** — Maintains converter amplitude by regulating for variances in the line voltages
- **Load Regulation** — Maintains converter amplitude over the full range of rated power
- **System Protection** — Protects the power supply by providing six levels of protection
  1. Voltage
  2. Current
  3. Phase
  4. Temperature
  5. Power
  6. Frequency

- **Web Page Interface** — Provides access, via Ethernet connection, to power supply information, diagnostics, and configuration web pages
- **Frequency Offset** — Provides for applying an external frequency offset to the operating frequency
- **Amplitude Control** — Provides complete control of amplitude throughout the weld cycle: programmable starting ramp, and digital setting of weld amplitude.

## 2.1.2 Power Supply Manual Set

The following documentation is available in electronic format for the Branson DCX S 120V Power Supply:

- DCX S-Series 120V Power Supply Instruction Manual (4000844)
- DCX S-Series 120V Power Supply Quick Start Guide (4000845)
- DCX Series Web Page Interface Instruction Manual (4000843)

## 2.2 Relation to other Branson Models

The DCX S-Series replaces the 2000b/bdc, 2000P, PGA, and NP power supplies.

NOTICE	
	The DCX S is not a direct replacement of the above mentioned power supplies. Please Contact Branson Product Support for additional information.

## 2.3 Compatibility with other Branson Products

**Table 2.2** Power Supply Compatibility with Branson Converters

DCX S Mode	Converter
20 kHz / 1250 W	CR-20S
	CR-20C
	CH-20S (932 AH SPL)
	CH-20C
	CS-20S
	CS-20C
40 kHz / 400 W	CR-40S (4TH)
40 kHz / 800 W	CR-40C
	4TP

## 2.4 Features

### 2.4.1 The Welding System

The welding system consists of a DCX S Power Supply and a converter-booster-horn stack. The system can perform ultrasonic welding, inserting, staking, spot welding, swaging, degating, and continuous ultrasonic operations. It is designed for automated, semi-automated and/or manual production operations.

### 2.4.2 The Power Supply

The DCX S-Series Power Supply consists of an ultrasonic power supply assembly with a system controller and user interfaces. The ultrasonic power supply assembly converts conventional 50/60 Hz line current to 20 kHz, or 40 kHz electrical energy. The system controller controls the welding system.

Listed below are the control features of the Branson DCX S-Series ultrasonic welding system

- **Autotuning:** Branson power supply tuning ensures that the system is running at peak efficiency
- **Digital Amplitude Setting:** This feature allows you to set the exact amplitude necessary for your application, allowing increased range and setting repeatability over analog systems
- **Frequency Offset:** This process feature allows a user to set a frequency value, for certain specific applications, where the force imparted on the fixture or anvil causes a frequency shift in the stack's operation. You should only use this feature when advised to do so by Branson
- **Horn Signature:** Using the DCX Web Page Interface, you may scan your ultrasonic stack to view its operating frequency on your computer, using digital readouts and bar graphs to give you the best picture of the stack's operation
- **LCD (Liquid Crystal Display):** Provides a clear visual interface to monitor and configure the system
- **Membrane Keys:** For high reliability and immunity from factory dust and oils
- **Login ID Numbers:** Allows for keeping track of user access to the DCX S Web Page Interface
- **Ramp Starting:** The starting of the DCX S-Series Power Supply and horn is done at a rate that helps reduce electrical and mechanical stress on the system. The horn start rate may be adjusted for some tough-to-start applications
- **Seek:** Ensures operation at resonance; minimizes tuning errors; and operates the stack at low amplitude (approximately 10%), then provides a means of sensing and storing the resonant operating frequency value
- **Start-up Diagnostics:** At start-up, the controls test the major internal components
- **Timed Seek:** When enabled, will do a Seek once every minute to update horn resonant frequency to memory. This is especially useful when the welding process affects the actual temperature of the horn, causing a resonant frequency shift
- **True Wattmeter:** The controls on the power supply include a true wattmeter for accurate measurement of power and energy
- **Web Page Interface:** Provides access, via Ethernet connection, to power supply information, diagnostics, and configuration web pages

### 2.4.3 The Actuator

The DCX S-Series Power Supply does not provide actuator control functions, and does not interface with actuator signals.

## 2.4.4 Converter/Booster/Horn Assembly

### The Converter

The ultrasonic electrical energy from the power supply is applied to the converter (sometimes called the transducer). This transforms the high frequency electrical oscillations into mechanical vibrations at the same frequency as the electrical oscillations. The heart of the converter is piezoelectric ceramic elements. When subjected to an alternating voltage, these elements alternately expand and contract, resulting in better than 90% conversion of electrical to mechanical energy.

### The Booster

Success in ultrasonic assembly depends on the right amplitude of movement at the horn face. Amplitude is a function of horn shape, which is largely determined by the size and form of the parts to be assembled. The booster can be used as a mechanical transformer to increase or decrease the amplitude of vibrations applied to the parts through the horn.

The booster is a resonant half-wave section of aluminum or titanium. It is mounted between the converter and the horn, as part of the ultrasonic stack. It also provides a clamping point for rigid stack mounting.

Boosters are designed to resonate at the same frequency as the converter with which they are used. Boosters are usually mounted at a nodal (minimum vibration) point of axial motion. This minimizes the loss of energy and prevents vibration from being transmitted to the stack supporting structure.

### The Horn

The horn is selected or designed for a specific application. Each horn is tuned typically as a half-wave section that applies the necessary force and vibration uniformly to the parts to be assembled. It transfers ultrasonic vibrations from the converter to the workpiece. The horn is mounted to the booster as part of the ultrasonic stack.

Depending on their profile, horns are referred to as stepped, conical, exponential, bar, or catenoidal. The shape of the horn determines the amplitude at the face of the horn. Depending on the application, horns can be made from titanium alloys, aluminum, or steel. Titanium alloys are the best materials for horn fabrication due to their high level of strength and low loss. Aluminum horns are usually chrome- or nickel-plated or hard-coated to reduce wear. Steel horns are for low amplitude requiring hardness, such as ultrasonic insertion applications.

## 2.5 Controls and Indicators

### 2.5.1 DCX S-Series Front Panel

**Figure 2.2** DCX S-Series Front Panel Controls and Indicators

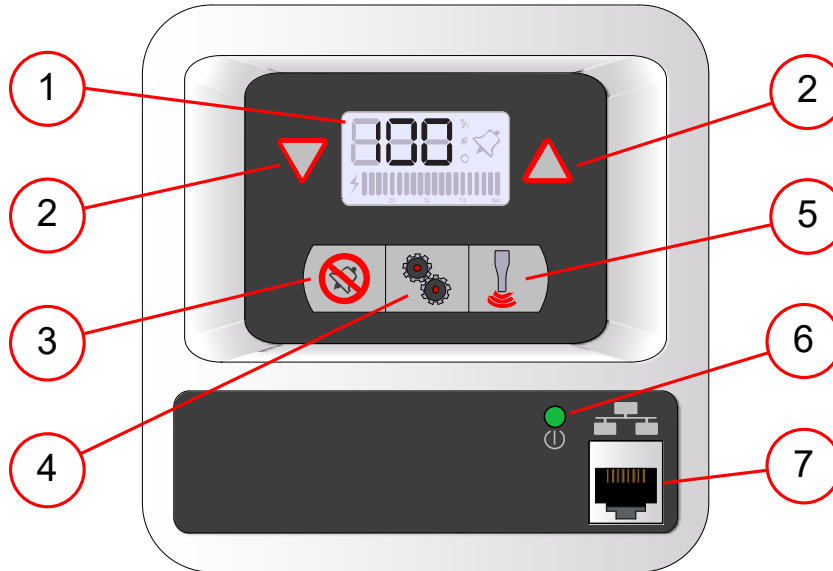

**Table 2.3** DCX S-Series Front Panel Controls and Indicators

Item	Name	Function
1	LCD	For detailed information refer to <a href="#">Figure 2.3 LCD Description</a> and <a href="#">Figure 2.3 LCD Description</a> .
2	Up/Down Arrow Keys	Use to adjust the amplitude of ultrasonic vibrations (10% to 100%). Also used to select registers and edit register values.
3	Alarm Reset Key	Use the Reset key to reset alarms. When changing system registers, use the Reset key to set a register back to its default value.
4	Configuration Key	Use the Configuration key to change system registers. For information on using the Configuration key to set system registers see <a href="#">6.4 Configuring the Power Supply Registers</a> .
5	Ultrasonic Test Key	Use the Test key to turn on Sonics.
6	Power-On indicator	Lights when the power supply is connected to main power and the power switch is on.
7	Ethernet Service Port	Use the Ethernet Service port to connect to the DCX S Power Supply Web Page Interface. For detailed information on using the web page interface refer to the DCX Series Web Page Interface Instruction Manual (4000843).

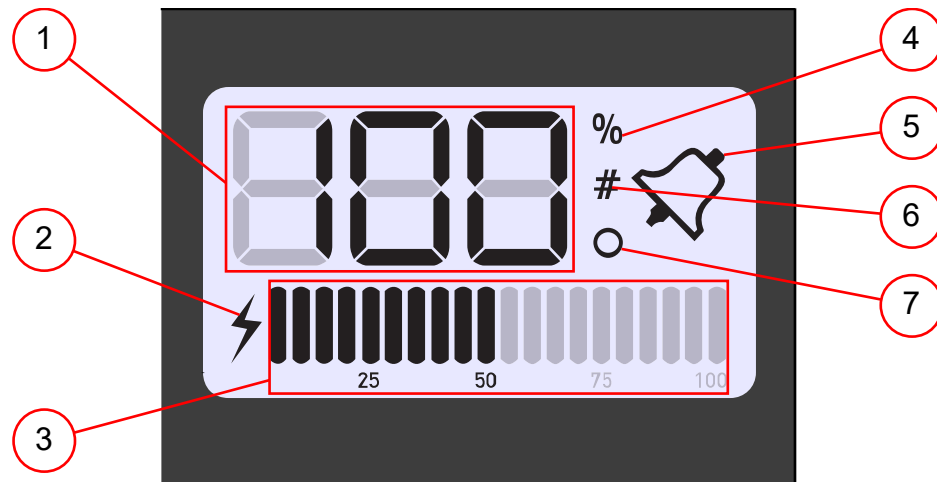
**Figure 2.3** LCD Description**Table 2.4** LCD Description

Item	Name	Function
1	Numeric Display	Displays the power supply amplitude setting, a register number, or a register value.
2	Sonics Active Indicator	Indicates ultrasonics is running.
3	Power/Frequency Bar Graph	Shows the true percentage of ultrasonic power during a weld cycle. The bar graph can be configured to show the peak power or the frequency at the end of each weld or test cycle. For instructions on how to modify this setting see <a href="#">6.4 Configuring the Power Supply Registers</a> .  For a detailed bar graph description, and bar graph reading examples, see <a href="#">6.5.2 Frequency Bar Graph Interpretation</a> .
4	Percentage Icon	Indicates the value shown is the amplitude setting.
5	Alarm Indicator Icon	A flashing Icon which indicates an alarm condition.
6	Number Sign Icon	Indicates that the value shown on the numeric display is a register number. Use Up and Down keys to select a register. For more information see <a href="#">6.4 Configuring the Power Supply Registers</a> .
7	Circle Icon	Indicates that the value shown on the numeric display is a register value. Use Up and Down keys to modify the register value. For more information see <a href="#">6.4 Configuring the Power Supply Registers</a> .

## 2.5.2 DCX S-Series Connections

**Figure 2.4** DCX S-Series Back Panel



**Table 2.5** Connections to the DCX S-Series 120V Power Supply

Item	Name	Function
1	Circuit Breaker / Power Switch	Turns the AC main power on or off.
2	Line Input Connector	Connector block for connecting the input power. For Electrical Connections details refer to <a href="#">Chapter 4: Installation and Setup</a> .
3	User I/O Connector	Provides the necessary input/output signals to interface with user automation or control interfaces. For detailed information on interfacing with the DCX S refer to <a href="#">Chapter 4: Installation and Setup</a> .
4	RF Connector	SHV connector for RF cable, which provides ultrasonic energy to the converter.
5	Ground Screw	Ground screw to serve as a redundant safety measure.

## **2.6 Welding Systems**

### **2.6.1 Principle of Operation**

Thermoplastic parts are welded ultrasonically by applying high frequency vibrations to the parts being assembled. The vibrations, through surface and intermolecular friction, produce a sharp rise in temperature at the welding interface.

When the temperature is high enough to melt the plastic, there is a flow of material between the parts. When the vibrations stop, the material solidifies under pressure and a weld results.

### **2.6.2 Weld System Applications**

DCX S-Series weld systems can be used for the following applications:

- Ultrasonic welding
- Cutting and sealing thermoplastic fabric and film
- Staking, spot welding, swaging, and degating thermoplastic parts
- Other ultrasonic processing applications

DCX S-Series weld systems typically consist of a power supply operated with a fixed converter-booster-horn stack.

## 2.7 Glossary

The following terminology may be encountered when using or operating a DCX S-Series ultrasonic welding system:

**Actuator:** The unit which houses the converter/booster/horn stack assembly in a rigid mounting, allowing the stack to move up and down, either mechanically or pneumatically, applying force to the part at a user-adjustable force and velocity.

**Alarm:** Visual indication of error.

**Amplitude Control:** The ability to set amplitude digitally or by an external control.

**Amplitude:** The peak-to-peak movement at the horn face. Always expressed as a percentage of the maximum.

**Booster:** A one-half-wavelength-long resonant metal section mounted between the converter and horn, sometimes having a change in cross-sectional area between the input and output surfaces. The booster mechanically alters the amplitude of vibrations received from the converter, and imparts the new amplitude to the horn.

**Clamping Force:** The pounds or kilograms exerted by the horn onto the workpiece.

**Converter:** The device that converts electrical energy into mechanical vibrations at a high frequency (an ultrasonic rate).

**Counters:** A record of the number of cycles, general alarms, power-on hours, etc, recorded in the power supply.

**Degating:** Removing a molded part from its runner system.

**Energy Director:** A triangular-shaped projection of plastic material which concentrates the ultrasonic energy at the joint interface of a plastic part.

**External Amplitude Control:** Enables you to access real-time amplitude control directly via the user I/O connector.

**External Frequency Control:** Enables you to access real-time frequency offset control directly via the user I/O connector.

**Fixture:** A device for holding a part in position for assembly.

**Flash:** Material displaced from the joint area.

**Forming:** Reshaping a section of thermoplastic.

**Fretting corrosion:** A black surface condition, that results from friction between metal parts, that appears on the converter-booster-horn stack mating surfaces.

**Frequency:** The operating frequency of the ultrasonic stack. The frequency stored is measured at the end of the ultrasonic portion of the cycle (when ultrasonics are terminated).

**Frequency Offset:** An offset factor applied to the ultrasonic frequency stored in the power supply.

**Gain:** The ratio of output to input amplitude of a horn or booster.

**Horn:** A bar or metal section, usually one half-wavelength-long which transfers vibratory energy to the workpiece.

**Horn Amplitude:** The peak-to-peak displacement of a horn at its work face.

**Horn Scan:** A scan to enhance selection of operating frequency and control parameters.

**Insertion:** The process of embedding a metal component in plastic.

**Interface:** 1. The contact surface of two mating parts. 2. The connection between two pieces of equipment.

**Joint:** The weld surfaces.

**Parameter:** A unique factor or element which affects the welding operation in a particular mode.

**Parameter Range:** Valid range of parameters accepted for a particular setup.

**Power Supply:** The electronic instrument in an ultrasonic assembly system which changes conventional 50/60 Hz electrical power into high frequency electrical power at 20 kHz, or 40 kHz.

**Seek:** The activation of ultrasonics at a low-level (10%) amplitude, for the purpose of finding the resonant frequency of the stack.

**Staking:** The process of melting and reforming a plastic stud to mechanically lock a dissimilar material in place.

**Swaging:** The process of capturing another component of an assembly by melting and reforming a ridge of plastic.

**Thermoplastic:** A polymer which undergoes a reversible change of state when subjected to heat.

**Thermoset:** A polymer which undergoes an irreversible change when subjected to heat.

**Ultrasonic power:** Presence of ultrasonic power at the horn face.

**Ultrasonic Welding:** The use of ultrasonic vibrations to generate heat and subsequently melt the mating surfaces of two thermoplastic parts. When ultrasonic vibrations stop, the molten material resolidifies, and a weld occurs.

**User ID:** A unique number used to keep track of user access to the web page interface.

**Weld system:** A combination of components required to perform an ultrasonic operation. Usually consists of a power supply, converter, booster, and horn, with either an actuator or a handheld device, or in a fixed, mounted location.



---

## **Chapter 3: Delivery and Handling**

---

<b>3.1</b>	<b>Shipping and Handling</b> .....	<b>30</b>
<b>3.2</b>	<b>Receiving</b> .....	<b>31</b>
<b>3.3</b>	<b>Unpacking the Power Supply</b> .....	<b>32</b>
<b>3.4</b>	<b>Take Inventory of Small Parts</b> .....	<b>33</b>
<b>3.5</b>	<b>Returning Equipment</b> .....	<b>34</b>

## 3.1 Shipping and Handling

CAUTION	General Warning
	<p>The power supply may be heavy. Handling, unpacking, and installation may require the assistance of a colleague or the use of lifting platforms or hoists.</p>

### 3.1.1 Environmental Specifications

The DCX S-Series Power Supply is an electronic unit that converts line voltage to ultrasonic energy and responds to user input for regulating the weld process. Its internal components are sensitive to static discharge, and many of its components can be harmed if the unit is dropped, shipped under improper conditions, or otherwise mishandled.

The following environmental guidelines should be respected in the shipping of the power supply.

**Table 3.1** Shipping Specifications

Environmental Condition	Acceptable Range
Storage / Shipping Temperature	-25° C / -13° F to +55° C / +131° F (+70° C / +158° F for 24 hours)
Shock / Vibration (transit)	45 g shock / 0.5 g and (3 to 100 Hz) vibration per ASTM 3332-88 and 3580-90
Drop Test	ISTA Procedure 1 & 2A (while packaged)
Humidity	30% to 95% (non-condensing)

## 3.2 Receiving

The DCX S-Series Power Supply is a sensitive electronic device. Many of its components can be harmed if the unit is dropped or otherwise mishandled.

### Scope of Delivery

Branson equipment is carefully checked and packed before dispatch. It is recommended, however, that you follow the procedure below upon receiving your DCX S-Series Power Supply.

**Inspect the Power Supply when it is delivered, take the following steps.**

**Table 3.2** Power Supply Inspection Procedure

Step	Action
1	Verify that all parts are complete according to the packing slip.
2	Check the packing and the unit for damage (visual inspection).
3	Report any damage claims to your carrier immediately.
4	Determine if any component has become loose during shipping and, if necessary, tighten screws.

NOTICE	
	<p>If the goods delivered have been damaged during shipping, please contact the forwarding agent immediately. Retain packing material (for possible inspection or for sending back the unit).</p>

## 3.3 Unpacking the Power Supply

NOTICE	
	<p>If there are any visible signs of damage to the shipping containers or the product, or you later discover hidden damage, NOTIFY YOUR CARRIER IMMEDIATELY. Save the packing material.</p>

The power supply is fully assembled. It is shipped in a sturdy cardboard box. Some additional items are shipped in the box with the power supply. Note orientation of packaging material in case return/repack is necessary. When unpacking the power supply, take the following steps:

**Table 3.3** Unpacking Procedure

Step	Action
1	Unpack the power supply as soon as it arrives. Save the packing material
2	Verify you have all of the equipment ordered. Some components are packed inside other boxes.
3	Inspect the controls, indicators, and surface for signs of damage.
4	Remove the cover of the power supply to check if any components became loose during shipping.

## 3.4 Take Inventory of Small Parts

**Table 3.4** Small Parts Included: Power Supply Assemblies

Part or Kit	20 kHz	40 kHz
Mylar <sup>®a</sup> plastic film Washer Kit	X	
Silicone Grease		X
Spanners (2)	X	X

a. Mylar is a registered trademark of DuPont Teijin Films.

### 3.4.1 Cables

The RF cable connects the power supply to the converter. For automated systems you will also need a user I/O cable to monitor and control the power supply. Check your invoice for cable types and cable lengths.

**Table 3.5** DCX S-Series

P/N	Description for Manual
100-240-383	Cable, RF 8 ft (2.5 m)
100-240-384	Cable, RF 15 ft (4.5 m)
100-240-385	Cable, RF 25 ft (7.5 m)
100-240-386	Cable, RF 50 ft (15 m)
100-240-387	Cable, RF right angle 8 ft (2.5 m)
100-240-388	Cable, RF right angle 15 ft (4.5 m)
100-240-389	Cable, RF right angle 25 ft (7.5 m)
100-240-390	Cable, RF right angle 50 ft (15 m)
100-240-392	Cable, User I/O 25 ft (7.5 m)
100-240-393	Cable, User I/O 50 ft (15 m)
200-240-396	Cable Ethernet Cat 5e 7 ft (2.1 m)
100-246-1625	Line Cord DCX 120V 15A (NEMA 5-15P)
100-246-1646	Line Cord DCX 120V 20A (NEMA 5-20P)

## 3.5 Returning Equipment

If you are returning equipment to Branson Ultrasonic Corporation, please call your Customer Service Representative to receive approval to return the goods.

If you are returning equipment for repair refer to [Chapter 1: Safety and Support 1.5 Returning Equipment for Repair](#) of this manual, for appropriate procedure.

---

## **Chapter 4: Installation and Setup**

---

<b>4.1</b>	<b>About Installation</b> .....	<b>36</b>
<b>4.2</b>	<b>Installation Requirements</b> .....	<b>37</b>
<b>4.3</b>	<b>Installation Steps</b> .....	<b>39</b>
<b>4.4</b>	<b>Power Supply Configuration</b> .....	<b>50</b>
<b>4.5</b>	<b>Assembling the Acoustic Stack</b> .....	<b>51</b>
<b>4.6</b>	<b>Converter Cooling</b> .....	<b>55</b>
<b>4.7</b>	<b>Testing the Installation</b> .....	<b>56</b>
<b>4.8</b>	<b>Still Need Help?</b> .....	<b>57</b>

## 4.1 About Installation

This chapter is intended to help the installer with the basic installation and setup of your new DCX S-Series 120V Power Supply.

<b>CAUTION</b>	<b>General Warning</b>
	The power supply, and related components are heavy. Handling, unpacking, and installation may require the assistance of a colleague or the use of lifting platforms or hoists.

International safety-related labels are found on the power supply. Those that are of importance during installation of the system are identified in [Figure 1.1](#).

## 4.2 Installation Requirements

This section covers the location requirements, mounting options, power supply dimensions, environmental requirements, and electrical requirements, to help you plan and execute your installation successfully.

### 4.2.1 Location

The power supply should be accessible for parameter changes or settings, and located in an area away from radiators or heating vents and positioned so it does not draw in dust, dirt or material via its cooling fan.

Refer to the illustration on the page that follow for dimensional drawing. All dimensions are approximate and may vary slightly:

**Figure 4.1** DCX S 120V Power Supply Dimensional Drawing

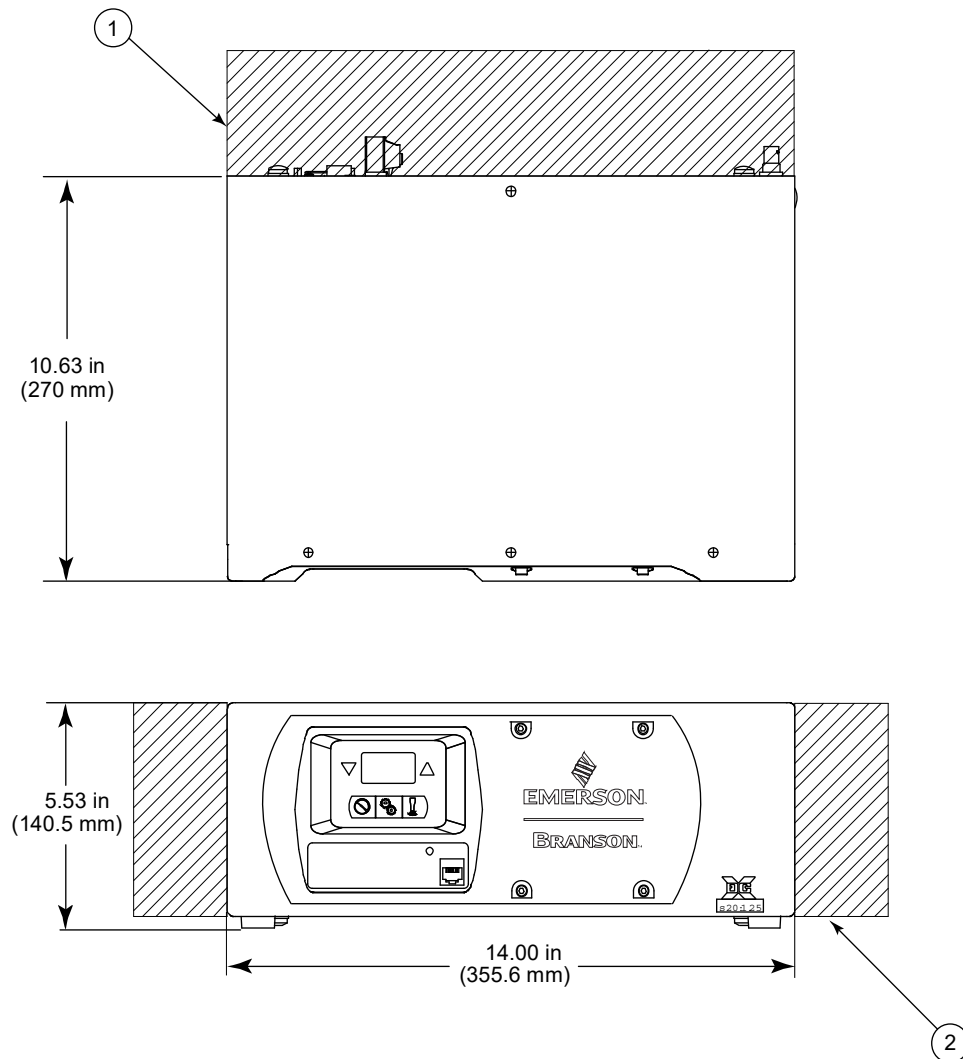

**Table 4.1** DCX S Power Supply Dimensional Drawing

Item	Note
1	5.0 in (127 mm) recommended clearance for cables.
2	3.0 in (76 mm) recommended fan clearance (both sides).

## 4.2.2 Environmental Requirements

Verify the DCX S Power Supply is operated in an environment that meets the temperature and humidity requirements indicated in [Table 4.2](#).

**Table 4.2** Environmental Requirements

Environmental Condition	Acceptable Range
Ambient Operating Temperature	+41° F to +104° F (+5° C to +40° C)
Humidity	30% to 95% (non-condensing)
IP Rating	20 Protected against solid objects larger than 12.5 mm; no protection against water.
Altitude	Up to 6560 ft (2000 m)
Pollution degree	2 Only non-conductive pollution occurs; temporary conductivity caused by condensation may be expected.
Overvoltage category	II Equipment intended to be supplied from the building wiring.

## 4.2.3 Electrical Input Power Ratings

Connect the power supply to a single-phase, grounded, 3-wire, 50 Hz or 60 Hz 100 V to 130 V power source. [Table 4.3](#) lists the current and breaker ratings for the various models.

**Table 4.3** Input Current and Circuit Breaker Specifications

Frequency	Power	Breaker Ratings
For 20 kHz models	1250 W	15 A Max. @ 100 V / 25 A Breaker
For 40 kHz models	400 W	5 A Max. @ 100 V / 15 A Breaker
	800 W	10 A Max. @ 100 V / 15 A Breaker

## 4.2.4 Pneumatic Requirements

Your welding system may require a cooling air stream for the converters. In continuous operations, or applications with longer duty cycles, it may be necessary to cool the horn as well as the converter.

Typically 80 cubic feet (2.26 m<sup>3</sup>) per hour of clean, dry, compressed air are required to cool most welding operations.

To verify the 80 cubic feet (2.26 m<sup>3</sup>) per hour cooling air stream required for your welding system, refer to [4.6 Converter Cooling](#).

## 4.3 Installation Steps

WARNING	General Warning
	<p>To prevent the possibility of an electrical shock:</p> <ul style="list-style-type: none"> <li>• Ensure the power source is disconnected before beginning to work on line connections</li> <li>• Ensure the power switch on the back of the unit is in the OFF position before making any electrical connections</li> <li>• Always plug the power supply into a grounded power source</li> <li>• To prevent the possibility of an electrical shock, ground the power supply by securing an 8 gage grounded conductor to the ground screw located next to the air outlet</li> <li>• Ensure power supply installation is performed by qualified personnel and in accordance with local standards and regulations</li> </ul>

### Basic installation notes:

- To avoid problems associated with EMI, you should route high power lines (AC and Ultrasonic RF) away from low power lines (controls signals)
- You should consider future troubleshooting and repair when installing all wiring. All wiring should be either color coded or tagged with industrial wire tags
- The minimum cable bend radius is 5 times the cable outer diameter for RF cables
- The minimum cable bend radius is 10 times the cable outer diameter for user I/O & Ethernet cables
- Ground wires should not be shared with other equipment
- All inductive coils must be suppressed with appropriate devices, such as diodes or RC networks

### 4.3.1 Mount the Power Supply

The cable lengths are limited based on the operating frequency of the welding system. Performance and results can suffer if the RF cable is crushed, pinched, damaged or modified. Contact your Branson Representative if you have special cable requirements.

Do not place the power supply on the floor or in other locations that will allow dust, dirt or contaminants to be drawn into the power supply.

NOTICE	
	<p>Special fan filter kit is available for use in dusty environments. See <a href="#">Table 7.11 Other Items used with the DCX-S Series Power Supply</a>.</p> <p>Do not block exhaust and intake air circulation, which is needed to maintain a safe operating temperature.</p>

The DCX S Power Supply is designed to be placed on a workbench (rubber feet on bottom) within cable-length limits of the stack. It has one fan which draws cooling air from the left side to the right side, which must be free from obstruction. The controls on the front of the power supply should be accessible and readable for setup changes.

All electrical connections are made to the rear of the power supply, which should be positioned in your workspace with adequate clearance, approximately 3 in (76.2 mm) or

more on either side, and 5 in (127 mm) to the rear for cable access and ventilation. Do not place anything on top of the power supply case.

For a dimensional drawing of the DCX S 120V Power Supply, see [Figure 4.1](#).

### 4.3.1.1 Mounting Considerations

In addition to the considerations mentioned above, the LCD's viewing angle should be taken into account when selecting a location for your DCX S Power Supply. The LCD is designed to be viewed from the top. Please refer to [Figure 4.2](#) below when selecting a location for your DCX S Power Supply.

**Figure 4.2** LCD Viewing Angle

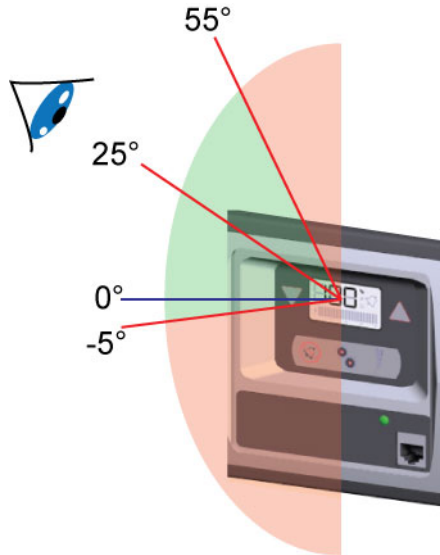

NOTICE	
	Optimal viewing angle is 25° above the normal to the display (indicated by 0°).

## 4.3.2 Electrical Connections

**Figure 4.3** DCX S 120V Power Supply Connections

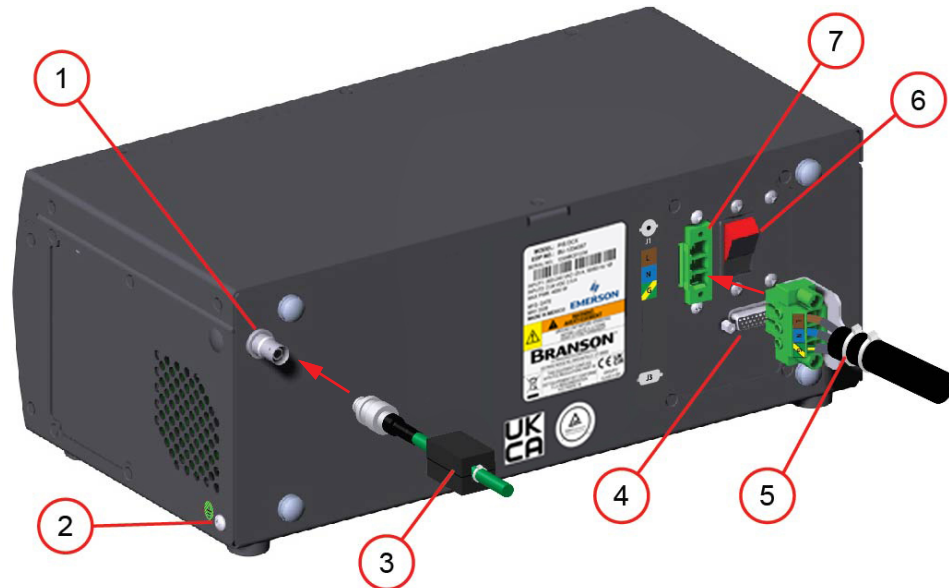

**Table 4.4** DCX S Electrical Connections

Item	Description
1	RF Connector
2	Ground Screw
3	RF Cable (Ferrite End)
4	User I/O Connector
5	Line Cord
6	Circuit Breaker (On/Off) Switch
7	Input Power Connector

### 4.3.2.1 User I/O Connections

The user I/O is a standard interface for automation, provided on the power supply. It provides the ability to make your own interface for your automation, special control, or reporting needs. The interface cable has a 26-pin HD male D-Sub connector on one end, and wires on the other end. Pins are wired to ICEA standard color code (see [Figure 4.4](#) and table [Table 4.6](#)).

#### NOTICE



Ensure all unused wires are properly isolated. Failure to do so may result in a power supply malfunction.

Digital I/O functions can be configured to either active-high or active-low using the DCX S Power Supply web page interface. Tables [Table 4.7](#) to [Table 4.10](#) list the input and output functions available on the DCX S Power Supply. See table [Table 4.11](#) for the default user I/O pin assignments.

[Figure 4.5](#) and [Figure 4.6](#) show typical wiring examples.

For complete instructions detailing the web page interface consult the DCX Series Web Page Interface Instruction Manual (4000843).

**Figure 4.4** User I/O Cable Identification and Wire Color Diagram

User I/O Cable  
 Stripped Jacket one end,  
 HD-26 male connector other end  
 (cable length as ordered)

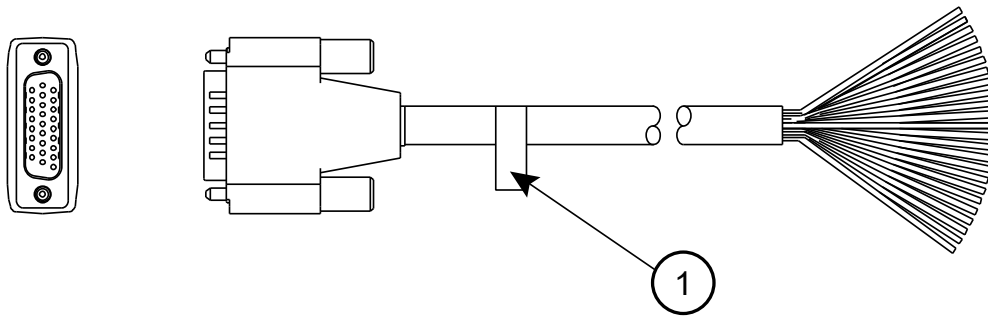

Wire Color Diagram  
 Two Colors = Insulator/Stripe  
 Three Colors = Insulator/Stripe/Dot

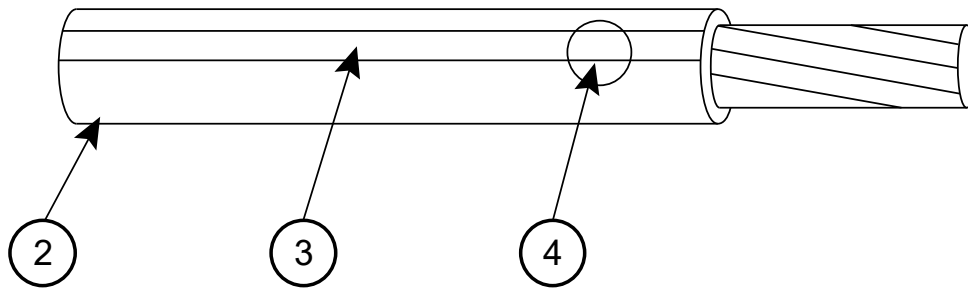

**Table 4.5** User I/O Cable Identification and Wire Color Diagram

Item	Description
1	Part number
2	Insulation
3	Stripe
4	Dot

**Table 4.6** User I/O Cable Pin assignments

Pin <sup>a</sup>	Input/Output (All I/O are user definable)	Available Function	Signal Type	Signal Range	Color
1	Digital in 1	See <a href="#">Table 4.7</a>	Discrete Input	0 V to 24 V +/-10%, 12 mA	Blk
2	Digital in 2				Wht
3	Digital in 3				Red
4	Digital in 4				Grn
5	+24 V Supplied from DCX S	N/A	24 V Source	24 V +/-10%, 250 mA Max	Orn
6					Blu
7	Digital out 1	See <a href="#">Table 4.8</a>	Discrete Output	0 V to 24 V +/-10%, 25 mA Max	Wht/Blk
8	Digital out 2				Red/Blk
9	Digital out 3				Grn/Blk
10	Digital out 4				Orn/Blk
14	GND	N/A	24 V Ground	0 V	Grn/Wht
15					Blu/Wht
17	Analog in 1	See <a href="#">Table 4.9</a>	Analog Input	0 V to +10 V, 2 mA	Wht/Red
18	Analog in 2				Orn/Red
24	Analog out 1	See <a href="#">Table 4.10</a>	Analog Output	0 V to +10 V, 1 mA Max	Red/Blk/Wht
25	Analog out 2				Grn/Blk/Wht
26	Analog GND	N/A	Analog Ground	0 V	Orn/Blk/Wht

a. Pins 11, 12, 13, 16, and 19-23 are not used.

**Table 4.7** Available Digital Input Functions

Function	Description
Cable Detect	Disables ultrasonics if 24V signal is removed when using 0V negative logic (active low) for the external Start input. Used to prevent ultrasonics from coming on if a cable is removed.
Display Lock	Locks the front panel display controls
External Horn Scan	Starts horn scan sequence.
External Reset	Resets alarm conditions.

**Table 4.7** Available Digital Input Functions

Function	Description
External Seek	Activates ultrasonic energy at 10% amplitude for the purpose of finding the ultrasonic stack resonant frequency.
External Start	Activates ultrasonic energy at the currently set amplitude. When using 0V to activate ultrasonics (External Start signal), it is recommended to assign one input as Cable Detect to prevent sonics from activating if 24V is lost by accident.
External Test	Performs a test cycle.
Memory Clear	Centers the power supply start frequency.

**Table 4.8** Available Digital Output Functions

Function	Description
General Alarm	Indicates an alarm occurred.
Overload Alarm	Indicates an overload alarm has occurred.
Ready	Indicates the system is ready.
Seek/Scan Out	Indicates either a seek or a horn scan is in progress.
Sonics Active	Indicates sonics are active.

**Table 4.9** Available Analog Input Functions

Function	Description	Valid Range	
Amplitude In	Controls the amplitude of ultrasonic energy that will be delivered by the power supply.	1 V to 10 V <sup>a</sup> (10% to 100%)	
Frequency Offset	Controls the frequency offset to the power supply operating frequency. Actual offset depends on the power supply operating frequency:	1 V to 9 V* (5 V is zero offset)	
	<b>Frequency</b>		<b>Offset Range</b>
	20 kHz		± 400 Hz
	40 kHz		± 800 Hz

- a. If the input signals are not within their valid range, or if left unconnected, the power supply will use 50% amplitude and zero frequency offset, respectively.

**Table 4.10** Available Analog Output Functions

Function	Description	Valid Range		
Amplitude Out	Provides a 0 V to 10 V output signal proportional to amplitude (0% to 100%).	0 V to 10 V (0% to 100%)		
Power Out	Provides a 0 V to 10 V output signal proportional to ultrasonic power output (0% to 100%).	0 V to 10 V (0% to 100%)		
Frequency Out	Provides a 0 V to 10 V output signal that indicates relative frequency in memory. Actual frequency depends on the power supply operating frequency:	0 V to 10 V (5 V is zero offset)		
	<b>P/S Frequency</b>		<b>Lower Limit (0V)</b>	<b>Upper Limit (10V)</b>
	20 kHz		19 450 Hz	20 450 Hz
	40 kHz		38 900	40 900 Hz

**Table 4.11** Default User I/O Connector Pin Assignments

PIN <sup>a</sup>	Function	I/O Type	Values
1	External Start	Input Digital	Apply +24 VDC to run cycle
2	External Seek	Input Digital	Apply +24 VDC to perform a seek
3	External Reset	Input Digital	Apply +24 VDC to reset alarm
4	Memory Clear	Input Digital	Apply +24 VDC to clear memory
5	+24 VDC Source from DCX S	I/O Signal Source	+24 V, 250 mA max. supplied from DCX S
6			
7	Ready	Output Digital	+24 V indicates the system is ready
8	Sonics Active	Output Digital	+24 V indicates ultrasonics are active
9	General Alarm	Output Digital	+24 V indicates an alarm occurred
10	Seek/Scan Out	Output Digital	+24 V indicates either Seek or a Scan is in progress
14	+24 VDC Return and I/O Return	I/O Signal Return	Return for all pins except pins 17, 18, 24, and 25
15			
17	Amplitude In	Input Analog	1 V to + 10 V (10% to 100%) <sup>b</sup>
18	Frequency Offset	Input Analog	1 V to + 9 V (5 V is zero offset) <sup>**</sup>
24	Power Out	Output Analog	0 V to + 10 V (0% to 100%)
25	Amplitude Out	Output Analog	0 V to + 10 V (0% to 100%)
26	Analog Signal Return	Analog Signal Return	Return for pins 17, 18, 24, and 25

a. Pins 11, 12, 13, 16, and 19-23 are not used.

b. If the input signals are not within their valid range, or if left unconnected, the power supply will use 50% amplitude and zero frequency offset, respectively.

**Figure 4.5** Typical Digital I/O Wiring Examples

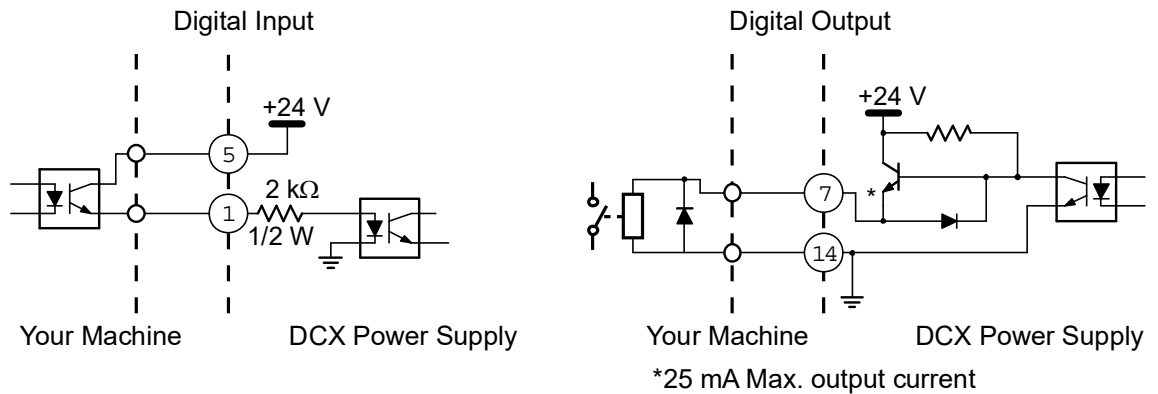

**Figure 4.6** Typical Analog I/O Wiring Examples

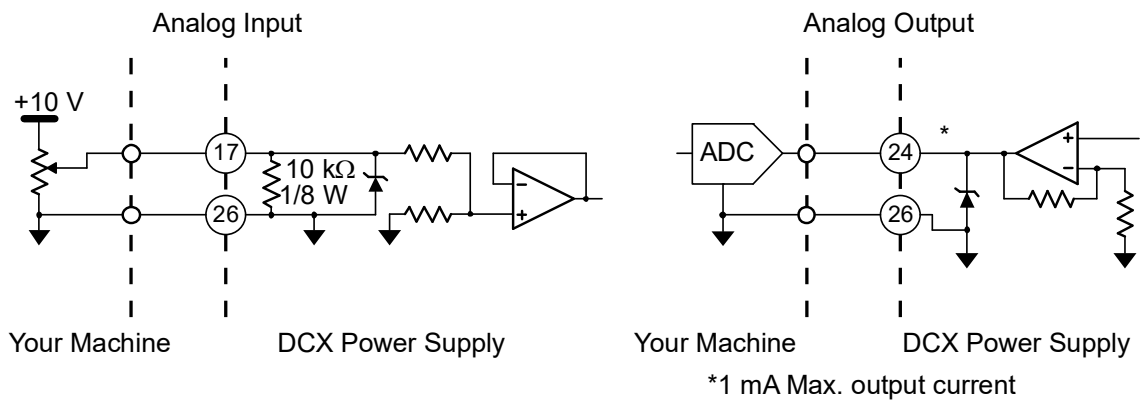

### 4.3.2.2 Output Power (RF Cable) Connection

Ultrasonic energy is delivered to the SHV connector on the power supply, which is then transmitted to the converter via the RF cable. The RF connector position is located on the rear panel of the power supply.

To reduce electromagnetic interference (EMI), RF cables are equipped with a ferrite core (plastic case) on one end. This end is meant to be connected to the power supply.

WARNING	High Voltage Hazard
	<p>Operating the System with the RF Cable disconnected or damaged can present an electrical shock hazard.</p> <p>To avoid the possibility of electrical shock, converters need to be properly grounded.</p>

NOTICE	
	<p>To avoid the possibility of EMI, ensure the RF connection to the power supply is made with the cable end that has the ferrite core box attached (see <a href="#">Figure 4.7</a>).</p>

**Figure 4.7** RF Cable Connection

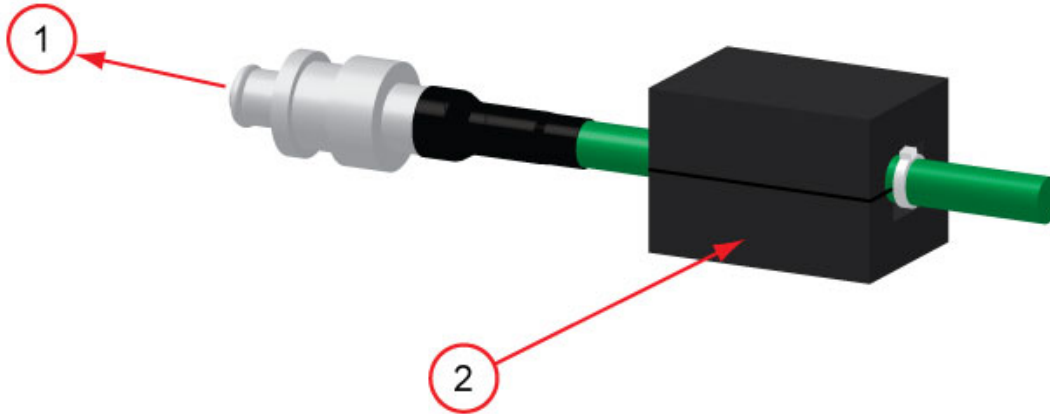

**Table 4.12** RF Cable Connection

Item	Description
1	To Power Supply
2	Ferrite Core Box

### 4.3.2.3 Input Power Connection

WARNING	High Voltage Hazard
	<p>To prevent the possibility of an electrical shock, ground the power supply by securing an 8 gage grounded conductor to the ground screw located next to the air outlet.</p>

NOTICE	
	<p>The power supply can be permanently damaged if it is connected to the incorrect line voltage.</p>

Use the following procedure to connect the power supply to a single-phase, grounded, 3-wire, 50 Hz or 60 Hz 100 V to 130 V power source.

**Table 4.13** Input Power Connection Procedure

Step	Action
1	Secure an 8 gage grounded conductor to the ground screw located next to the air outlet.
2	Connect the converter-booster-horn stack to the power supply using the RF cable. See <a href="#">4.3.2.2 Output Power (RF Cable) Connection</a> .
3	Ensure the power switch on the back of the unit is in the OFF position. Plug the line cord into the power supply. Tighten the two securing screws.
4	Connect the power supply to a single-phase, grounded, 3-wire, 50 Hz or 60 Hz 100 V to 130 V power source.

## 4.4 Power Supply Configuration

### 4.4.1 Selecting the Alarm Mode

The DCX Power Supply activates ultrasonic power after receiving an External Start signal. Ultrasonic power remains on until you turn off the power supply or the External Start signal. The DCX Power Supply response to alarm conditions can be configured to operate in one of two modes:

- **Latching:** In this mode the DCX Power Supply requires alarm conditions to be reset before a new weld cycle can begin. To reset alarm conditions while in this mode, either press the front panel Reset key or send an External Reset signal using the user I/O connector
- **Non-Latching:** In this mode the DCX Power Supply does not require alarm conditions to be reset, and new weld cycle can begin upon receiving an External Start signal

The alarm mode is factory-set to non-latching. For instruction on how to change the alarm mode refer to [6.4 Configuring the Power Supply Registers](#) in [Chapter 6: Operation](#) and to your DCX Series Web Page Interface Instruction Manual (4000843).

### 4.4.2 Configuring the Power Supply



Certain power supply configurations can be modified from the factory setting if needed. Although not usually requiring modifications from the factory setting, the following features are selectable:

- **Amplitude control:** Allows for varying the amplitude (10% to 100%) using the front panel LCD, the web page interface, or by way of external controls (analog signal applied through the user I/O analog input)
- **Latching Alarms:** Provides an option for selecting the power supply alarms to be latching (reset required) or non-latching (reset by reapplying the start signal)
- **Start Ramp Time:** Provides a selection for different start ramp times. This controls how fast the amplitude of the horn rises from zero to the currently set amplitude. Long ramp times may be useful when using large horns or high gain stacks
- **End of Weld Frequency Store:** Provides an option for selecting if the stack frequency is stored at the end of each weld cycle
- **Seek Ramp Time:** Provides a selection for different power supply seek ramp times
- **Timed Seek:** Provides an option for monitoring, and storing the operating frequency at timed intervals (60 seconds). Periodic frequency seeks may be helpful when welder is not used for long periods of time. Seeks are timed from the moment sonics was last activated
- **Seek Time:** Provides an option for selecting seek duration
- **Frequency offset:** Allows for varying the start frequency by way of external controls (analog signal applied through the user I/O analog input) or setting a fixed value using the web page interface. This is useful for certain applications, where the force imparted on the fixture or anvil causes a frequency shift in the stack's operation

For instruction on how to change the power supply settings refer to [6.4 Configuring the Power Supply Registers](#) in [Chapter 6: Operation](#) and to your DCX Series Web Page Interface Instruction Manual (4000843).

NOTICE	
	Consult with Branson before changing any default factory setting.

## 4.5 Assembling the Acoustic Stack

CAUTION	General Warning
	<p>The following procedure must be performed by a trained operator. If necessary, secure the largest portion of a square or rectangular horn in a soft jawed vise. NEVER attempt to assemble or remove a horn by holding the converter housing or the booster clamp ring in a vise.</p> <p>Do not use silicone grease with Mylar® plastic film washers. Use only 1 (one) Mylar® plastic film washer of the correct inside and outside diameters at each interface.</p>
NOTICE	
	<p>The use of a Branson torque wrench or the equivalent is recommended. P/N 101-063-787 for 20 kHz systems and 101-063-618 for 40 kHz systems.</p>

**Figure 4.8** Assembling the Acoustic Stack

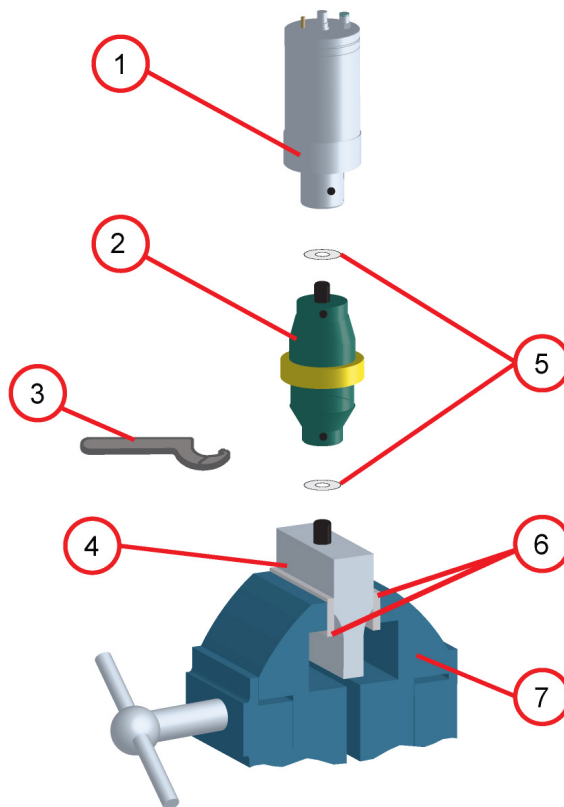

**Table 4.14** Assembling the Acoustic Stack

Item	Description
1	Converter
2	Booster
3	Spanner (provided)
4	Horn
5	See stack assembly procedure
6	Vise Jaw protectors (aluminum or soft metal)
7	Vise

**Table 4.15** Stack Torque Values

Frequency	Torque
20 kHz	220 in·lb (24.85 N·m)
40 kHz	95 in·lb (10.73 N·m)

**Table 4.16** Tools

Tool	EDP Number
20 kHz Torque Wrench Kit	101-063-787
40 kHz Torque Wrench	101-063-618
20 kHz Spanner Wrench	101-118-039
40 kHz Spanner Wrench	201-118-024
Silicone Grease	101-053-002
Mylar <sup>®</sup> Plastic Film Washers (20 kHz)	100-063-357

### 4.5.1 For a 20 kHz System

**Table 4.17** Acoustic Stack Assembly Procedure for 20 kHz

Step	Action
1	Ensure that the mating surfaces of the converter, booster, and horn are clean, and that the threaded holes are free of foreign material.
2	Install a single Mylar® plastic film washer (matching the size of the washer to the stud) to each interface.
3	Assemble the converter to the booster and the booster to the horn.
4	Torque to 220 in·lb (24.85 N·m) at each interface.

### 4.5.2 For a 40 kHz System

**Table 4.18** Acoustic Stack Assembly Procedure for 40 kHz

Step	Action
1	Ensure that the mating surfaces of the converter, booster, and horn are clean, and that the threaded holes are free of foreign material.
2	Coat each interface surface with a thin film of silicon grease - <i>but do not apply silicon grease to a threaded stud or tip.</i>
3	Assemble the converter to the booster and the booster to the horn.
4	Torque to 95 in·lb (10.73 N·m) at each interface.

### 4.5.3 Connecting Tip to Horn

1. Ensure that the mating surfaces of the tip and horn are clean. Remove any foreign matter from the threaded stud and hole.
2. Hand assemble the tip to the horn. Assemble dry. Do not use any silicone grease.
3. Use the spanner wrench and an open-end wrench (refer to [Figure 4.9](#)) and tighten to the following torque tip specifications:

**Figure 4.9** Connecting Tip to Horn

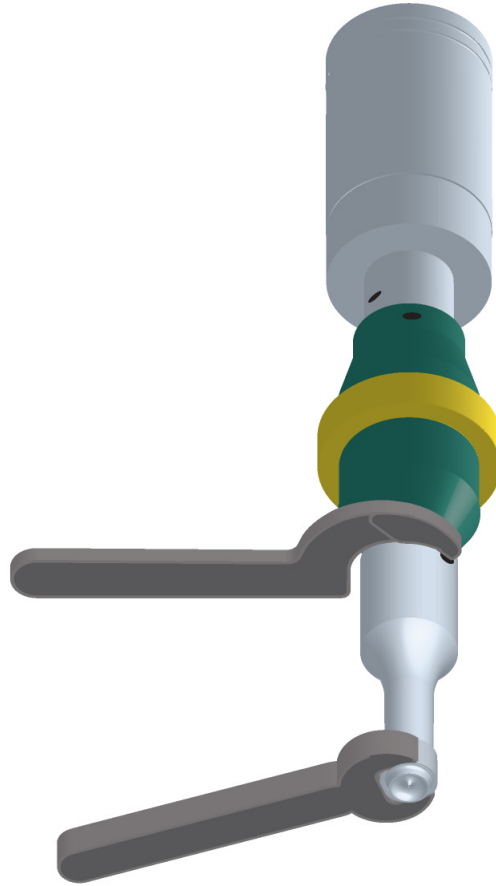

**Table 4.19** Tip to Horn Torque Values

Tip Thread	Torque
1/4 - 28	110 in·lbs (12.42 N·m)
3/8 - 24	180 in·lbs (20.33 N·m)

## 4.6 Converter Cooling

Converter performance and reliability can be adversely affected if the converter ceramics are subjected to temperatures above 140° F (60° C). The converter front driver temperature should not exceed 122° F (50° C).

To prolong converter life and maintain a high degree of system reliability, the converter should be cooled with clean, dry, compressed air, particularly if your application calls for continuous ultrasonic operation. Converter cooling is especially critical in 40 kHz applications.

Use one of the following procedures to determine if a converter is operating close to the maximum allowable temperature. Check converter temperature immediately after substantial machine operation and without power applied to the horn.

- Press a pyrometer probe (or similar temperature measuring device) against the front driver of the converter assembly. Wait for the probe to reach the temperature of the shell. If the temperature is 120° F (49° C) or higher, the converter requires a cooling air stream
- If a temperature measuring device is unavailable, use your hand to feel the shell of the converter. If the converter is hot to touch, the converter requires a cooling air stream

High duty cycles require additional cooling for the converter. System average power must be limited to the specified continuous maximum. Higher peak power, up to the maximum acceptable power limit, with an on time of up to 10 seconds may be obtained, if appropriate off time ensures that, on average, the continuous duty maximum power is not exceeded.

**Table 4.20** Continuous Duty Maximum Power & Full Power Duty Cycle

Configuration	Continuous Duty Max. Power	Full Power Duty Cycle
20 kHz / 1250 W	800 W	10 s on 10 s off (50% Duty Cycle)
40 kHz / 400 W	300 W	10 s on 10 s off (50% Duty Cycle)
40 kHz / 800 W	400 W	10 s on 10 s off (50% Duty Cycle)

If converter cooling is required, use the following steps:

**Table 4.21** Converter Cooling Procedure

Step	Action
1	Start with a 50 psi (345 kPa) air source or higher from a 0.06 in (1.5 mm) I.D. orifice.
2	Perform a run of welding operations.
3	Immediately after completing the welding run, check the converter temperature.
4	If the converter is still too hot, increase the diameter of the orifice in small increments until the temperature falls within the ranges in the chart.

A 0.06 in (1.5 mm) orifice at 50 psi (345 kPa) will result in a reading of 80 ft<sup>3</sup> (2.26 m<sup>3</sup>) per hour. This should be sufficient to cool most operations requiring a cooling air stream. In continuous welding operations, or applications with longer duty cycles, it may be necessary to cool the horn as well as the converter. Horns may require cooling because of the heat transfer from contacting the work piece.

## 4.7 Testing the Installation

To test the power supply follow the procedure described in [6.7 Ultrasonics Test Procedure](#) in [Chapter 6: Operation](#).

## 4.8 Still Need Help?

Branson is pleased that you chose our product and we are here for you! If you need parts or technical assistance with your DCX Series system, call your local Branson representative. Please refer to [Table 1.2 Branson Contacts](#) on [Chapter 1: Safety and Support](#) for a list of Branson key contacts.



---

## **Chapter 5: Technical Specifications**

---

<b>5.1</b>	<b>Technical Specifications . . . . .</b>	<b>60</b>
<b>5.2</b>	<b>Physical Description . . . . .</b>	<b>62</b>
<b>5.3</b>	<b>Standard Modules and Components . . . . .</b>	<b>63</b>

## 5.1 Technical Specifications

NOTICE	
	All specifications are subject to change without notice.

### 5.1.1 Environmental Specifications

The DCX S-Series Power Supply has the following environmental specifications:

**Table 5.1** Environmental Specifications

Environmental Condition	Acceptable Range
Ambient Operating Temperature	+41° F to +104° F (+5° C to +40° C)
Storage / Shipping Temperature	-13° F to +131° F (-25° C to +55° C)
Humidity	30% to 95% (non-condensing)
Altitude	Up to 6560 ft (2000 m)
IP Rating	20 Protected against solid objects larger than 12.5 mm; no protection against water.
Pollution degree	2 Only non-conductive pollution occurs; temporary conductivity caused by condensation may be expected.
Overvoltage category	II Equipment intended to be supplied from the building wiring.

## 5.1.2 Electrical Specifications

The following tables list input voltage and current requirements for the DCX S-Series 120V Power Supply.

**Table 5.2** Electrical Input Operating Voltages

Power Supply Rating	Input Operating Voltage
All Models	100 V to 120 V, 50 Hz or 60 Hz, Single Phase

**Table 5.3** Input Current and Circuit Breaker Specifications

Frequency	Power	Circuit Breaker
For 20 kHz models	1250 W	15 A Max. @ 100 V / 25 A Breaker
For 40 kHz models	400 W	5 A Max. @ 100 V / 15 A Breaker
	800 W	10 A Max. @ 100 V / 15 A Breaker

**Table 5.4** Continuous Duty Maximum Power

Configuration	Continuous Duty Max. Power
20 kHz / 1250 W	800 W
40 kHz / 400 W	300 W
40 kHz / 800 W	400 W

Cycle Rate – up to 200 cpm. Cycle rate including off time is application and stack dependent.

NOTICE	
	<p>High duty cycles require additional cooling for the converter. For information on converter cooling refer to <a href="#">4.6 Converter Cooling</a> in <a href="#">Chapter 4: Installation and Setup</a>.</p> <p>System average power must be limited to the specified continuous maximum. Higher peak power, up to the maximum acceptable power limit, with an on time of up to 10 seconds may be obtained if appropriate off time ensures that, on average, the Continuous Duty Maximum Power is not exceeded.</p>

## 5.2 Physical Description

This section describes the physical dimensions of the DCX S-Series 120V Power Supply.

NOTICE	
	Dimensions are nominal.

**Table 5.5** Dimensions and Weights of DCX S-Series 120V Power Supplies

Dimension / Weight	Value
Height	5.53 in (140.5 mm)
Width	14.00 in (355.6 mm)
Depth	10.63 in (270.0 mm)
Weight	22.00 lb (10.0 kg)

For detailed dimensional information refer to [Chapter 4](#).

## 5.3 Standard Modules and Components

The following sections describe the DCX internal circuits.

### 5.3.1 System Block Diagram

The block diagram for the DCX S-Series Power Supply is shown below.

**Figure 5.1** System Block Diagram

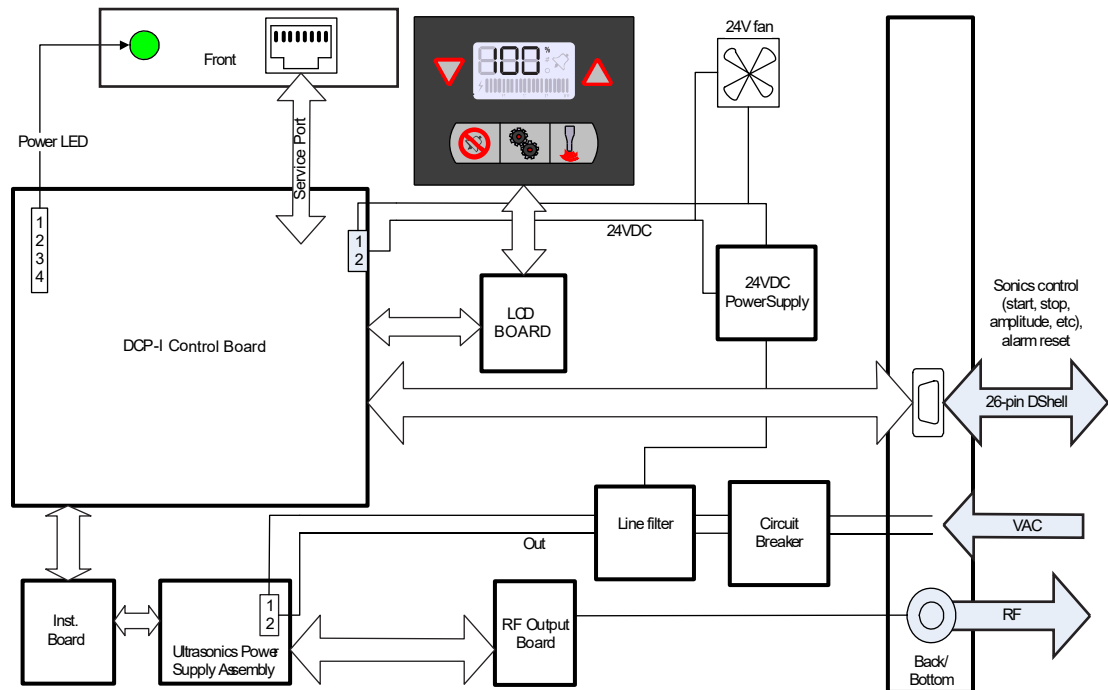

### 5.3.2 Circuit Descriptions

The DCX S-Series Power Supply contains the following subassemblies:

- DCP-I Control Board
- LCD Board
- Ultrasonics Power Supply Assembly
- Line Filter
- 24 VDC Power Supply

#### DCP-I Control Board

The DCP-I Control Board controls the following functions of the power supply:

- Responding to start and stop signals
- Responding to alarm and reset signals
- Responding to user input
- Controlling and monitoring ultrasonics
- Providing information for the Front Panel LCD
- Generating alarms
- Controlling communications
- Storing operating frequency of last weld (frequency memory) and using the stored frequency as a starting point for the next weld

- Checking and updating frequency memory on start-up
- Providing starting ramp times (Start)
- Provide a standard interface for automation (26-pin HD D-Sub Connector)

## LCD Board

The LCD Board controls the Front Panel LCD interface and communicates user input to the DCP-I Control Board.

## Ultrasonic Power Supply Assembly

The ultrasonic power supply assembly generates ultrasonic energy at the resonant frequency of your converter-booster-horn stack. The ultrasonic power supply assembly contains three main circuits.

- **320 VDC Power Supply:** converts AC line voltage to +320 VDC for the output power devices
- **Output circuit:** matches the impedance of the output power device to the converter-booster-horn stack; and provides feedback to the control circuit
- **Interface circuits:** perform the following functions:
  - Provide drive signal to output power device
  - Determine true percentage of ultrasonic power used over a range of amplitudes
  - Allow control of the resonant frequency
  - Control starting amplitude
  - Provide overload protection for the ultrasonic power assembly

## Line Filter

The line filter performs the function of providing RFI filtering for the line voltage input to the power supply. The filtering also blocks ultrasonic signals from entering the AC main line.

## 24 VDC Power Supply

The 24 VDC power supply provides +24 VDC for the DCP-I control board, LCD board, user I/O signals, and DC fan.

### 5.3.3 Converters and Boosters

A variety of converters and boosters available for use with the DCX S-Series Power Supply are illustrated in the following pages.

WARNING	High Voltage Hazard
	<p>To avoid the possibility of electrical shock, converters need to be properly grounded.</p>

**Figure 5.2** 20 kHz typical Converter Dimensions

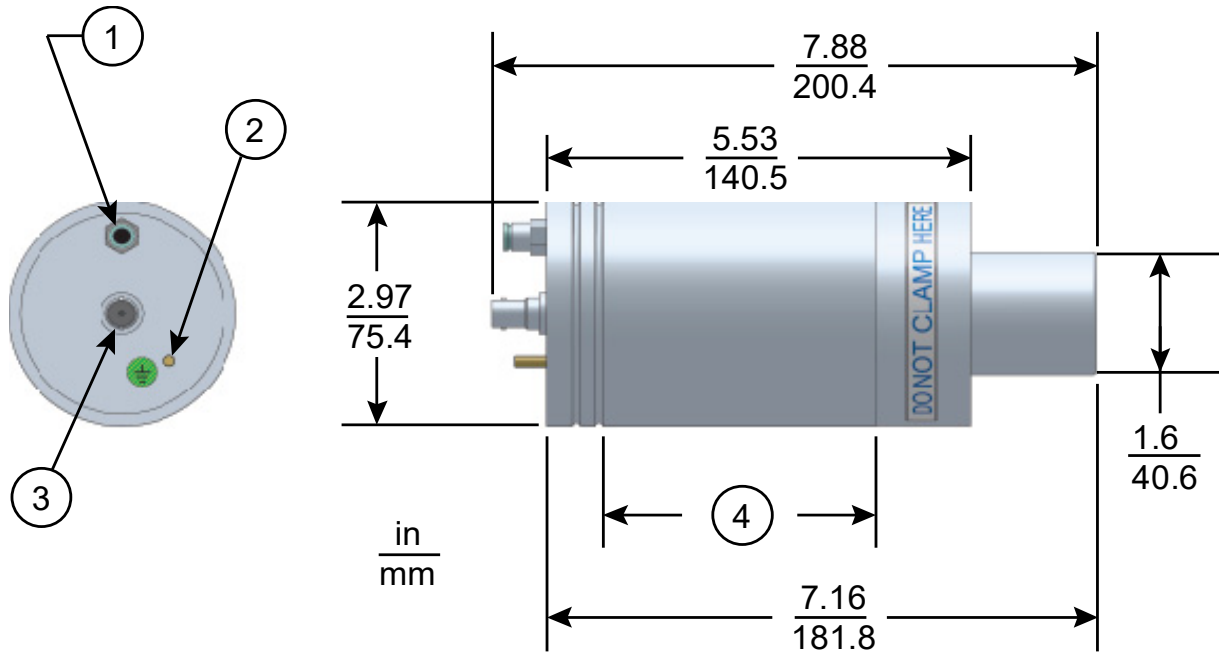

**Table 5.6** 20 kHz Converter

Item	Description
1	Air inlet
2	Ground stud
3	SHV connector
4	Grip area

**Figure 5.3** 20 kHz CH-20S Converter Dimensions

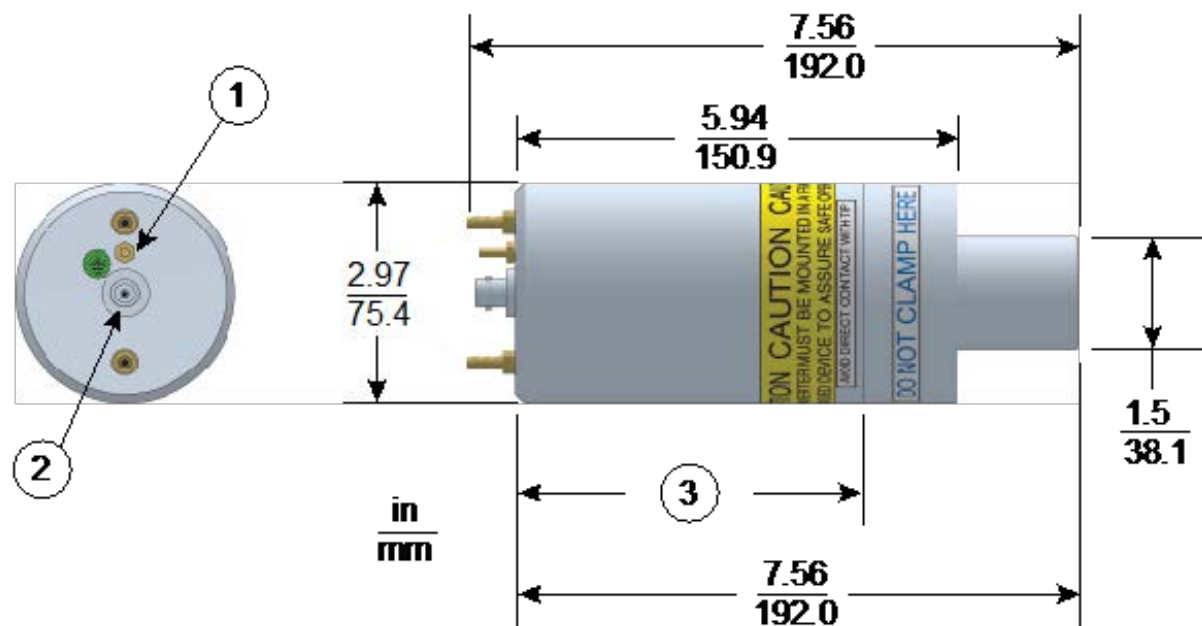

**Table 5.7** 20 kHz CH-20S Converter

Item	Description
1	Ground stud
2	SHV connector
3	Grip area

**Figure 5.4** 20 kHz Booster Dimensions

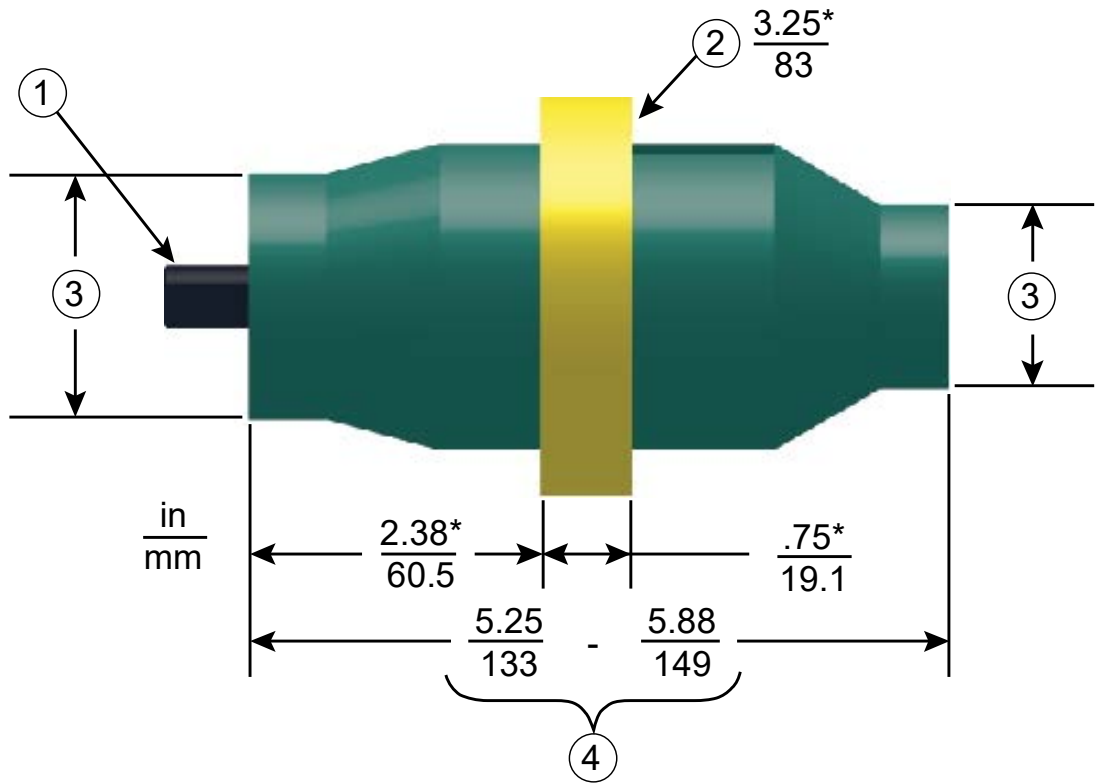
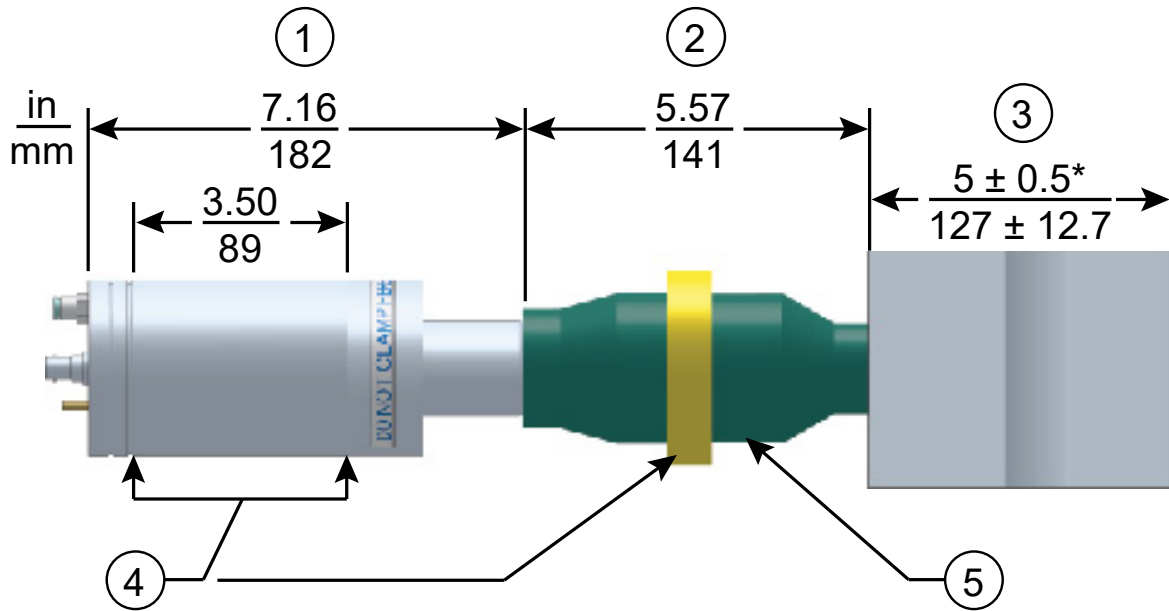

**Table 5.8** 20 kHz Booster

Item	Description
1	1/2 - 20 x 1 - 1/4 stud (Ti boosters) 1/2 - 20 x 1 - 1/2 stud (Al boosters)
2	Grip Ring Diameter
3	Variable
4	Varies with tuning and gain

\*These dimensions do not vary.

**Figure 5.5** 20 kHz Converter/Booster/Horn, Typical Dimensions

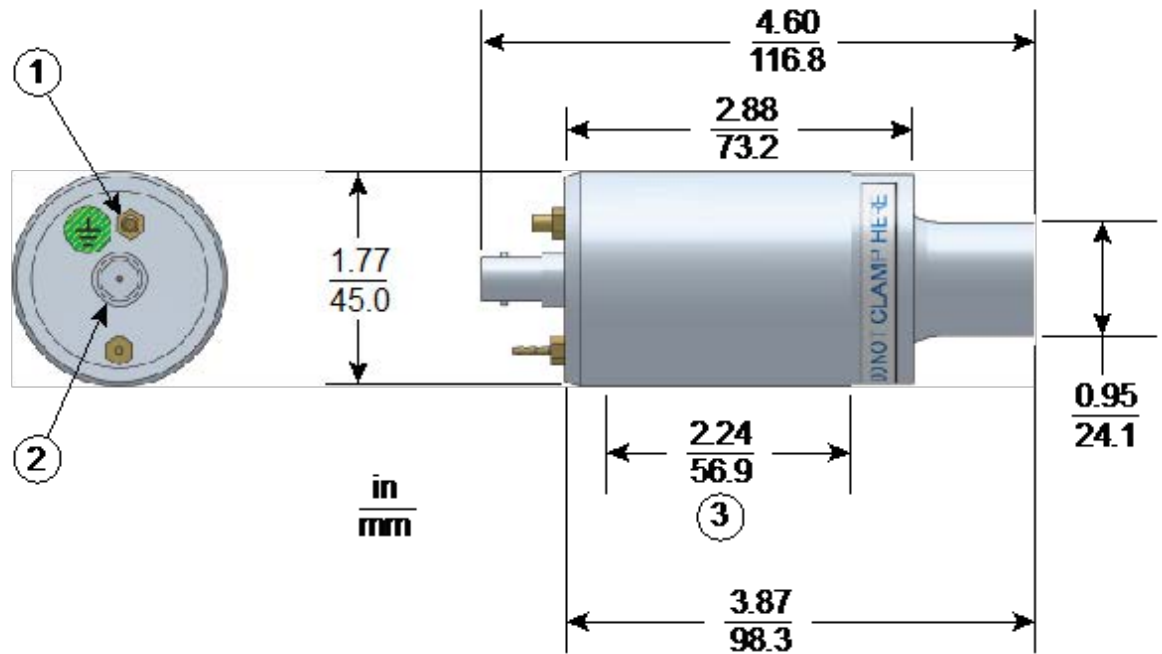

**Table 5.9** 20 kHz Stack

Item	Description
1	Converter
2	Booster
3	One-half wavelength horn
4	Recommended clamping area
5	Booster front end diameter will vary with amplitude

\*Overall horn length can vary beyond these typical dimensions depending on the application.

**Figure 5.6** 40 kHz 4TJ Converter Dimensions



**Table 5.10** 40 kHz 4TJ Converter

Item	Description
1	Ground stud
2	SHV connector
3	Grip area

**Figure 5.7** 40 kHz Booster Dimensions

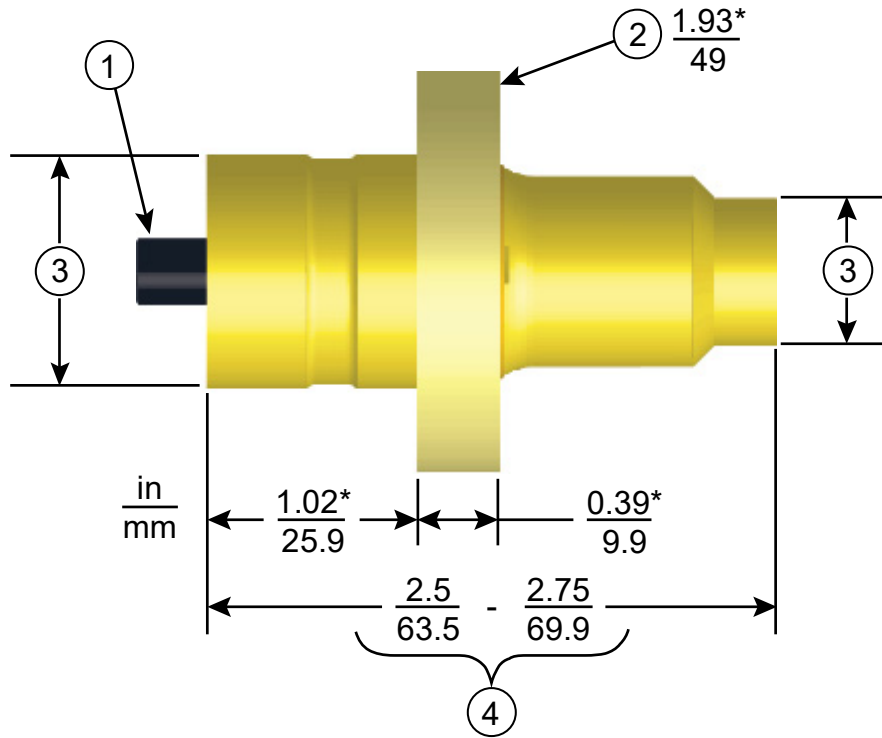

**Table 5.11** 40 kHz Booster

Item	Description
1	M8 x 1 - 1/4 stud (Ti boosters), M8 x 1 - 1/2 stud (Al boosters)
2	Grip ring diameter
3	Variable
4	Varies with tuning and gain

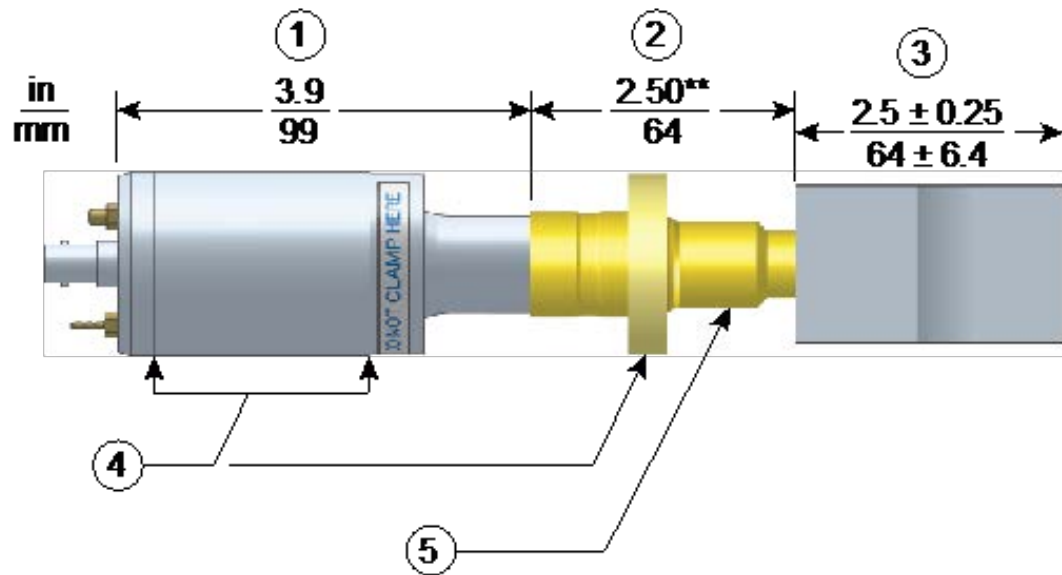
**Figure 5.8** 40 kHz Converter/Booster/Horn, Typical Dimensions**Table 5.12** 40 kHz Stack

Item	Description
1	Converter
2	Booster
3	One-half wavelength horn
4	Recommended clamping area
5	Booster front end diameter will vary with amplitude

\*Overall horn length can vary beyond these typical dimensions depending on the application.

\*\*Dimension varies with tuning and gain.

### 5.3.4 Component Functional Description

## Ultrasonic Stack

### Converter

The converter is mounted in the customer's automation as part of the ultrasonic stack. The ultrasonic electrical energy from the power supply is applied to the converter (sometimes called the transducer). This transforms the high frequency electrical oscillations into mechanical vibrations at the same frequency as the electrical oscillations. The heart of the converter are piezoelectric ceramic elements. When subjected to an alternating voltage, these elements alternately expand and contract, resulting in better than 90% conversion of electrical to mechanical energy.

## Booster

It is important to be able to modify the horn face amplitude for successful ultrasonic assembly. The booster provides a means to modify the amplitude. It is designed to couple different ratios of ultrasonic energy to the horn, which will in turn increase or decrease the amplitude at the face of the horn. This is accomplished by varying the ratios of the masses of the input and output half sections of the booster.

The booster is a resonant half-wave section of aluminum or titanium. It is mounted between the converter and the horn, as part of the ultrasonic stack. It also provides a clamping point for rigid stack mounting.

## Horn

The horn is selected or designed for a specific application. Each horn is tuned typically as a half-wave section that applies the necessary force and vibration uniformly to the parts to be assembled. It transfers ultrasonic vibrations from the converter to the workpiece. The horn is mounted to the booster as part of the ultrasonic stack.

Depending on their profile, horns are referred to as stepped, conical, exponential, bar, or catenoidal. The shape of the horn determines the amplitude at the face of the horn. Depending on the application, horns can be made from titanium alloys, aluminum, or steel. Titanium alloys are the best materials for horn fabrication due to their high level of strength and low loss. Aluminum horns are usually chrome- or nickel-plated or hard-coated to reduce wear. Steel horns are for low amplitude requiring hardness, such as ultrasonic insertion applications.

## Solid Mount Boosters

The solid mount booster is a one-half wave-length resonant section made exclusively of titanium. It is mounted between the converter and the horn, modifying the amplitude of vibration applied to the horn and providing a clamping point.

The solid mount booster is superior to prior versions in that deflection is minimized. This is the result of a redesigned clamp-ring which employs a metal-to-metal press fit rather than an O-ring assembly.

The advantage this booster offers is its improved rigidity. For continuous applications, this means more energy delivered to the product, while in plunge applications, improved alignment is possible. The solid mount provides improved positional alignment and will benefit continuous applications where high force, high side load, or high cycle rates are necessary. In plunge welding applications, overall deflection is reduced by an average of 0.0025 in. (0.064 mm) over a wide variety of materials, joint designs, and operating conditions. The results of this testing in combination with information drawn from field testing indicate that the solid mount will benefit plunge applications where precision alignment is necessary (such as staking, swaging, or insertion) or where concentricity/parallelism is critical.

---

## **Chapter 6: Operation**

---

<b>6.1</b>	<b>Activating Ultrasonic Power</b> .....	<b>74</b>
<b>6.2</b>	<b>Setting the Amplitude</b> .....	<b>75</b>
<b>6.3</b>	<b>Resetting the Power Supply Alarms</b> .....	<b>77</b>
<b>6.4</b>	<b>Configuring the Power Supply Registers</b> .....	<b>78</b>
<b>6.5</b>	<b>LCD Bar Graph</b> .....	<b>81</b>
<b>6.6</b>	<b>Web Page Interface</b> .....	<b>84</b>
<b>6.7</b>	<b>Ultrasonics Test Procedure</b> .....	<b>88</b>

## 6.1 Activating Ultrasonic Power

On DCX Power Supplies, ultrasonic power activates after receiving an External Start signal at the corresponding user I/O. Ultrasonic power remains On until you turn off the power supply or the External Start signal. For default user I/O assignment see [4.3.2.1 User I/O Connections](#) for information on configuring the power supply user I/O refer to your DCX Series Web Page Interface Instruction Manual (4000843).

## 6.2 Setting the Amplitude

### 6.2.1 Using the Front Panel Controls

At power up the DCX S Power Supply will display the last amplitude setting on the LCD.

**Figure 6.1** LCD at Power Up

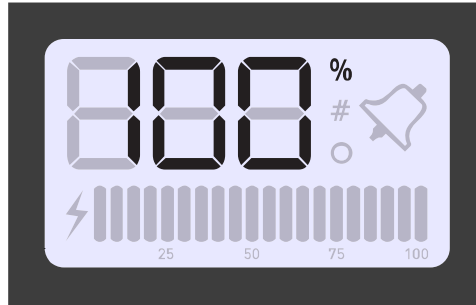

**Table 6.1** Setting the Amplitude Using the Front Panel Controls

Step	Action	Reference
1	Press the Configuration key until the percentage icon (%) appears on the LCD.	
2	<ul style="list-style-type: none"> <li>Press and release the Up or Down arrow keys to select the desired amplitude at 1% increments</li> <li>Press and hold down the Up or Down arrow keys and the Amplitude will auto increment at 1% increments every quarter of a second</li> <li>After holding down an arrow key for four straight seconds, the amplitude will auto increment at 5% increments every quarter of a second</li> </ul>	

## 6.2.2 Using External Amplitude Control

When External Amplitude Control is enabled, the front panel amplitude control is disabled and the LCD displays three dashes (see [Figure 6.2](#) below).

**Figure 6.2** LCD when in External Amplitude Control Mode

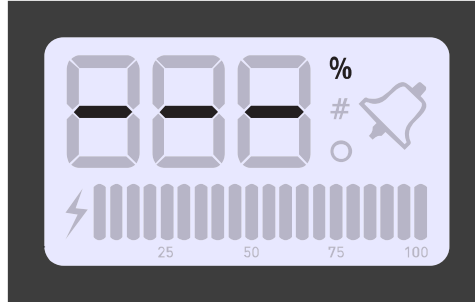

The ultrasonic amplitude can be controlled using one of the two analog input pins on the user I/O connector (pins 17 and 18). For information on configuring the power supply user I/O refer to your DCX Series Web Page Interface Instruction Manual (4000843).

## 6.2.3 Using the Web Page Interface

The ultrasonic amplitude can be set to a user specified value using the web page interface. For more information, refer to your DCX Series Web Page Interface Instruction Manual (4000843).

## 6.3 Resetting the Power Supply Alarms

You need to reset the weld system when you get an overload. When there is an overload, the alarm icon appears on the front panel LCD and the General Alarm output on the user I/O connector becomes active. The procedure for resetting the power supply depends on the power supply alarm settings. Refer to [Table 6.2](#) for reset procedures.

**Table 6.2** Resetting the DCX S Power Supply

Alarm Setting	Reset Procedure
Latching Alarms	Press the front panel Reset key. You can also send an External Reset signal.
Non-Latching Alarms	Remove and re-apply the start signal.

NOTICE	
	Alarm circuitry requires at least 20 ms before restarting ultrasonic power.

For more information on interfacing the DCX S Power Supply using the user I/O connections refer to [4.3.2.1 User I/O Connections](#) in [Chapter 4: Installation and Setup](#).

## 6.4 Configuring the Power Supply Registers

At power up the DCX S-Series Power Supply will display the last amplitude setting, this is indicated by the percentage icon (%) on the LCD. Refer to [Figure 6.1](#).

**Table 6.3** Steps to configure the Power Supply Registers

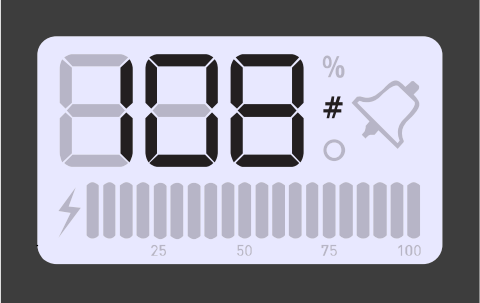
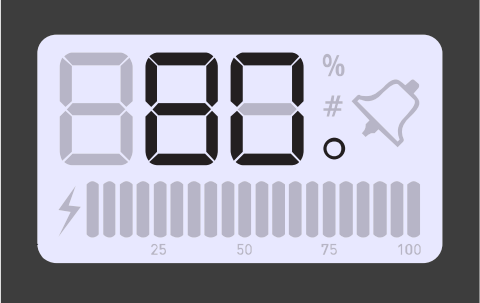
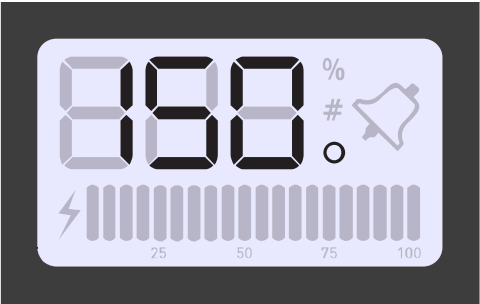
Step	Action	Reference
1	<ul style="list-style-type: none"> <li>Press the Configuration key until the number icon (#) appears on the LCD</li> <li>The power supply will display register 101 the first time you access the registers. (If you access the registers again the last selected register will be displayed)</li> </ul>	
2	<p>Press and release the Up or Down arrow keys to select the desired register. For a detailed description of available registers refer to <a href="#">Table 6.4</a>.</p>	
3	<p>Once you have reached the desired register, press the Configuration key. The register value will be displayed, this is indicated by the circle icon.</p>	
4	<ul style="list-style-type: none"> <li>Press and release the Up or Down arrow keys to enter the desired value at 1 increments</li> <li>Press and hold down the Up or Down arrow keys and the value will auto increment at 1 increments every quarter of a second</li> <li>After holding down an arrow key for four straight seconds, the value will auto increment at 5 increments every quarter of a second</li> <li>Or press the Reset key to enter the default value. For detailed default values of available registers refer to <a href="#">Table 6.4</a></li> </ul>	

**Table 6.3** Steps to configure the Power Supply Registers

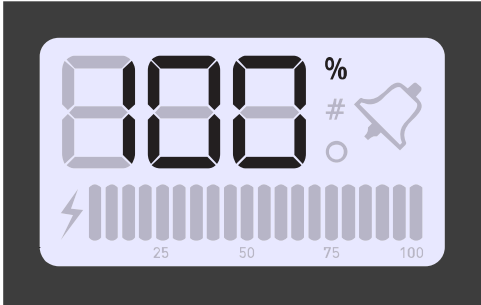
Step	Action	Reference
5	Press the Configuration key to save the value. The current amplitude setting will be displayed.	

**Table 6.4** Power Supply Registers

Register	Description	Read Only	Min. Value	Max. Value	Default Value
0 -100	Unused				
101	LCD Software version	Yes	0	999	N/A
102	Bar graph identification after weld complete		0 (power)	1 (freq)	0 (power)
103	Latching Alarms (reset required)		0 = OFF	1 = ON	0 = OFF
104	External amplitude control - user analog input		0 = OFF	1 = ON	0 = OFF
105	Start ramp time (ms)		1	999	80
106	Store frequency at end of weld		0 = OFF	1 = ON	1 = ON
107	Power-on seek/scan (0 = off, 1 = seek, 2 = scan)		0 = OFF	2	1 = seek
108	Seek ramp time (ms)		1	999	80
109	Timed seek (every 60 seconds)		0 = OFF	1=on	0 = OFF
110	Seek time (ms)		1	999	500
111	Frequency offset		0 = OFF	1 = ON	0 = OFF
112	Reserved	Yes	0	0	0
113	Reserved	Yes	0	0	0
114	Reserved	Yes	0	0	0
115	Restore defaults (0 = off, 1 = Weld Presets Only, 2 = All System Defaults)		0 = OFF	2	0 = OFF
116	IP address - 1	Yes	0	255	192
117	IP address - 2	Yes	0	255	168

**Table 6.4** Power Supply Registers

Register	Description	Read Only	Min. Value	Max. Value	Default Value
118	IP address - 3	Yes	0	255	10
119	IP address - 4	Yes	0	255	100
120	Gateway for IP address 1	Yes	0	255	-
121	Gateway for IP address 2	Yes	0	255	-
122	Gateway for IP address 3	Yes	0	255	-
123	Gateway for IP address 4	Yes	0	255	-
124	Subnet Mask for IP address 1	Yes	0	255	255
125	Subnet Mask for IP address 2	Yes	0	255	255
126	Subnet Mask for IP address 3	Yes	0	255	255
127	Subnet Mask for IP address 4	Yes	0	255	0
128	DHCP Setting (0 = Server; 1 = Client; 2 = Static IP; 3 = Restore Registers 116 - 127 to default values)		0	3	2
129	Amplitude		10	100	100
200	Reserved		0	999	

## 6.5 LCD Bar Graph

While ultrasonic power is active the LCD will always display the power value on the 20-segment LCD bar graph as a percentage of the maximum output power.

At the end of a weld or test cycle, the bar graph is factory set to represent the cycle's peak power as a percentage of the maximum output power.

The power supply can also be configured to show a single bar on the LCD bargraph to represent the stack operating frequency stored at the end of each weld or test cycle. This option can be used to troubleshoot operating frequency changes as a result of heating effects, coupling, tooling wear, etc. When using this feature the option "Store frequency at end of weld" must also be enabled.

For information on how to set the power supply registers see [6.4 Configuring the Power Supply Registers](#).

### 6.5.1 Power Bar Graph Interpretation

The lightning bolt left of the bar graph indicates ultrasonic power is running. Each of the segments represent 5% increments of the maximum output power. The segments will only appear if the output power has exceeded the value represented. For example if the power is 4% only the lightning bolt will be on. When it reaches 5% the first bar graph segment will appear.

**Figure 6.3** Power Bar Graph Interpretation Examples

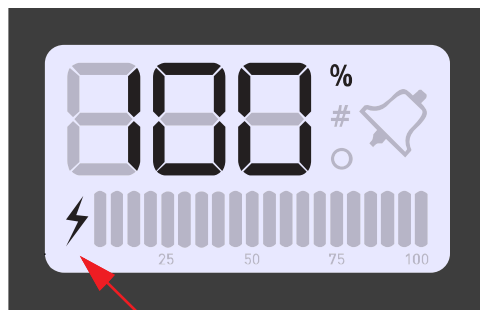

In this example only the lightning bolt appears left of the bargraph. This means power is between 0% and 5%. If the power supply is 800W the actual output power is between 0W and 40W.

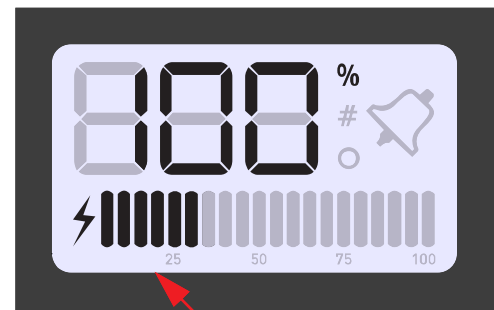

In this example the first six segments appear on the bargraph. This means power is between 30% and 35%. If the power supply is 800W, the actual output power is between 240W and 280W.

## 6.5.2 Frequency Bar Graph Interpretation

The actual frequency depends on the power supply's operating frequency. Use [Table 6.5](#) to [Table 6.6](#) below to interpret frequency bar graph readings.

NOTICE	
	<p>If there is a test overload or an external memory reset signal is received, then the 50% segment will be displayed and blinking.</p>

**Table 6.5** Frequency Bar-Graph Interpretation - 20 kHz (50 Hz Segment)

20 kHz (50 Hz/Segment)	
1	19,475-19,524
2	19,525-19,574
3	19,575-19,624
4	19,625-19,674
5 (25%)	19,675-19,724
6	19,725-19,774
7	19,775-19,824
8	19,825-19,874
9	19,875-19,924
10 (50%)	19,925-19,974
11	19,975-20,024
12	20,025-20,074
13	20,075-20,124
14	20,125-20,174
15 (75%)	20,175-20,224
16	20,225-20,274
17	20,275-20,324
18	20,325-20,374
19	20,375-20,424
20 (100%)	20,425-20,474

**Table 6.6** Frequency Bar-Graph Interpretation - 40 kHz (100 Hz/Segment)

40 kHz (50 Hz/Segment)	
1	38,950-39,049
2	39,050-39,149
3	39,150-39,249
4	39,250-39,339
5 (25%)	39,350-39,449
6	39,450-39,549
7	39,550-39,649
8	39,650-39,749
9	39,750-39,849
10 (50%)	39,850-39,949
11	39,950-40,049
12	40,050-40,149
13	40,150-40,249
14	40,250-40,349
15 (75%)	40,350-40,449
16	40,450-40,549
17	40,550-40,649
18	40,650-40,749
19	40,750-40,849
20 (100%)	40,850-40,949

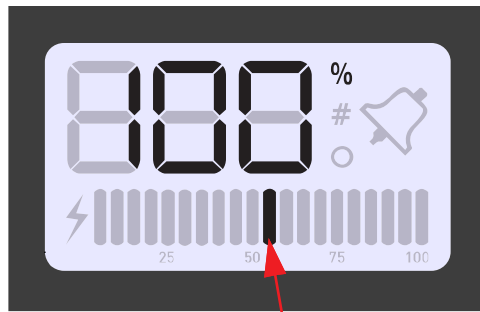
**Figure 6.4** Frequency Bar Graph Interpretation Examples

In this example the bar is located in the 11<sup>th</sup> segment. If the power supply is a 20 kHz unit, the stack is running in the frequency range of 19975 Hz to 20024 Hz.

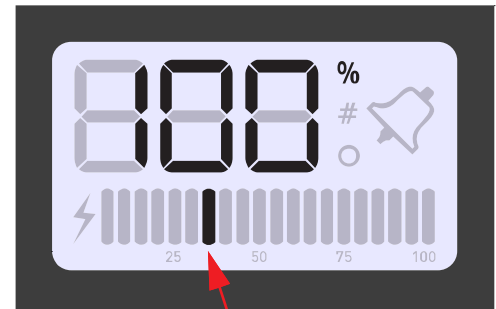

In this example the bar is located in the 7<sup>th</sup> segment. If the power supply is a 20 kHz unit, the stack is running in the frequency range of 19775 Hz to 19824 Hz.

## 6.6 Web Page Interface

The DCX S Power Supply web page interface provides access, via Ethernet connection, to power supply information, diagnostics, and configuration web pages. Communication can be established point-to-point or through a local area network.

### 6.6.1 System Requirements

To connect to the DCX WebPage Interface you will need a PC running a Windows<sup>®1</sup> operating system with a Google Chrome<sup>™2</sup> or Microsoft Edge<sup>®1</sup> web browser software.

### 6.6.2 Connecting to the Web Page Interface

NOTICE	
	The DCX Power Supply is not compatible with network scanning software. If your local network uses these types of programs, the DCX Power Supply IP address must be placed in an exclusion list.

NOTICE	
	A shielded Ethernet cable should be used to connect to the DCX Power Supply Web Page Interface to prevent possible EMI (Electromagnetic Interference) issues.

#### 6.6.2.1 Point to Point Connection (Windows 10<sup>®</sup> or Windows 11<sup>®</sup>)

To connect directly to the DCX Power Supply Web Page Interface using a PC with Windows 10<sup>®1</sup> or Windows 11<sup>®1</sup> operating system, complete the following steps:

1. Connect the power supply to a computer via the Ethernet port.
2. Turn on the power supply.
3. On your PC, click the Start button on the taskbar and search for the **Control Panel**.
4. Select **View Large Icons** on the top right corner.
5. Select **Network and Sharing Center**.

---

1. Windows10, Windows 11, and Microsoft Edge are registered trademarks of Microsoft Corporation.  
2. Google Chrome is a trademark of Google LLC..

6. Select **Change adapter settings**.

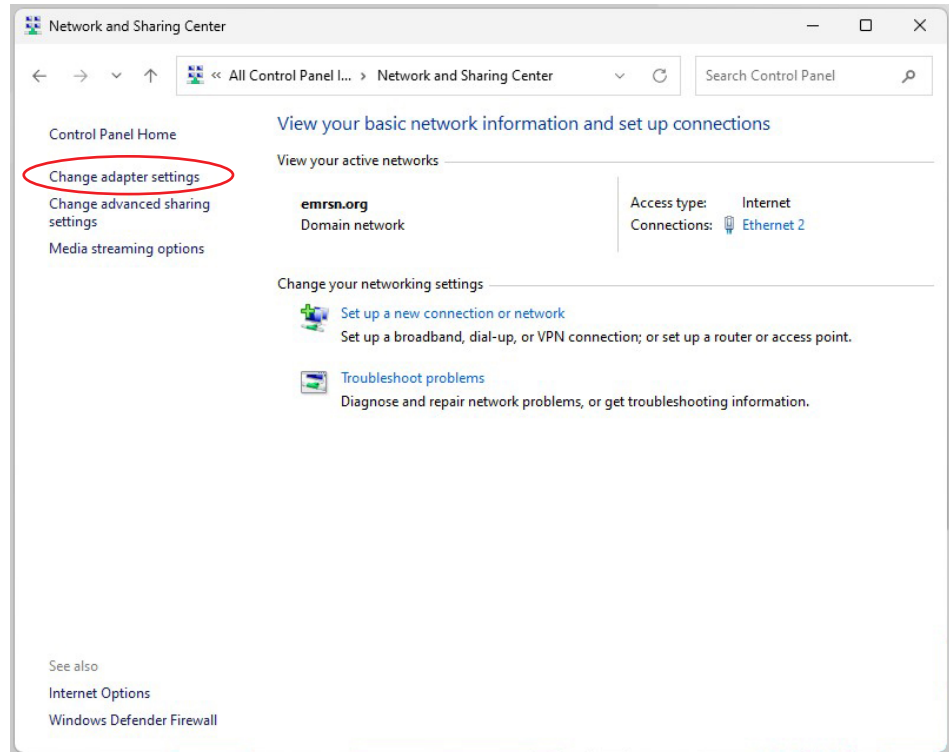

7. Right click on **Ethernet 2** and select **Properties** to bring up the **Networking** tab. You might be prompted to elevate rights.

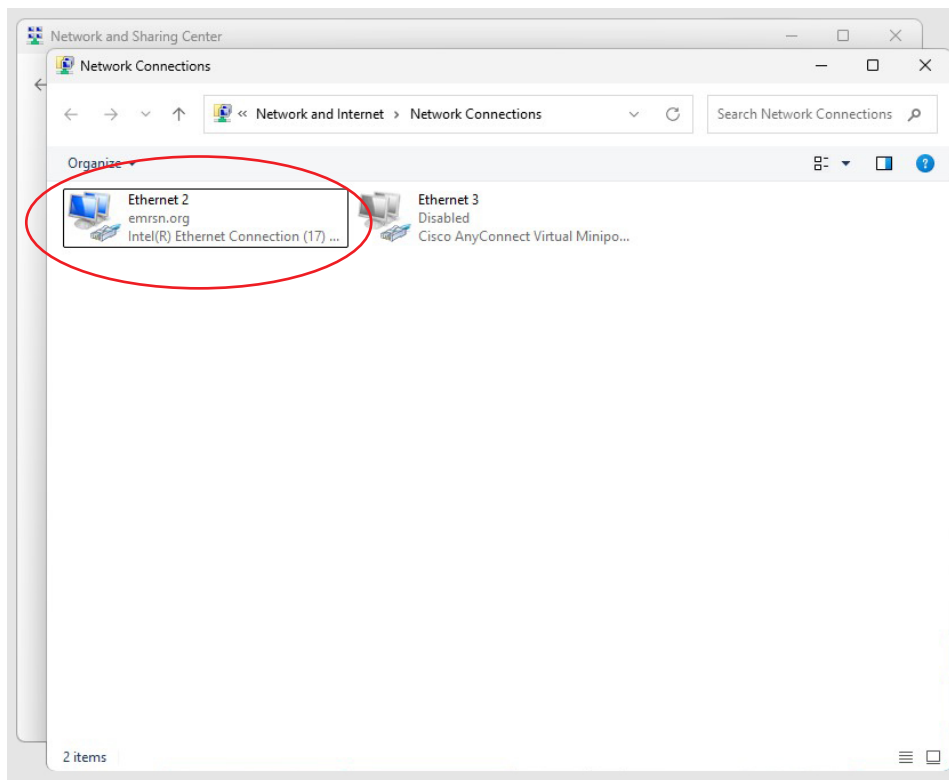

8. Highlight **Internet Protocol Version 4 (TCP/IPv4)** from the list and click on **Properties**.

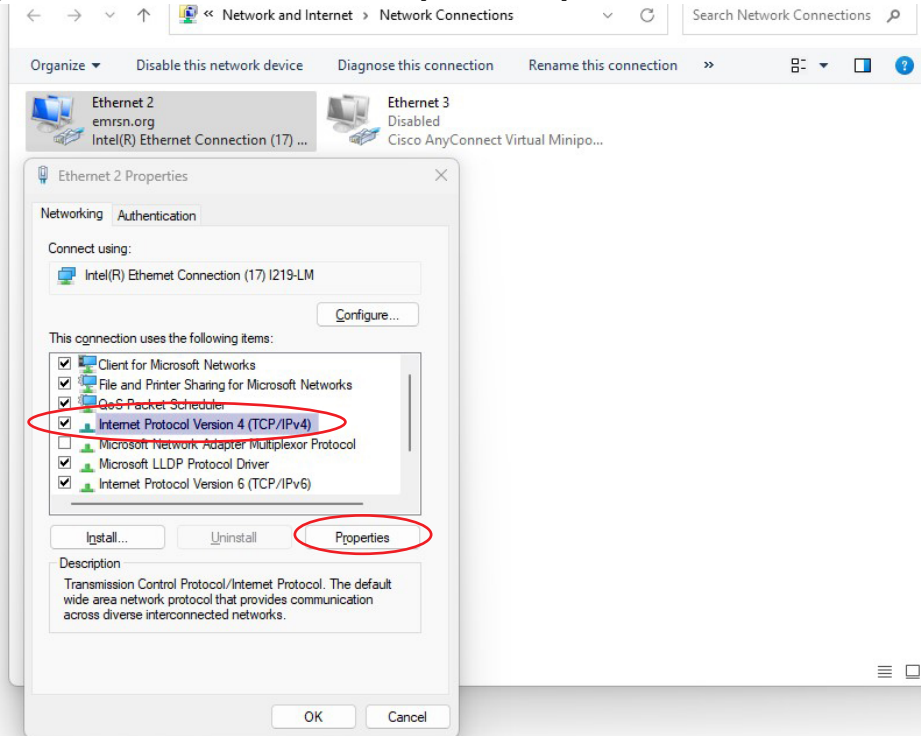

9. Use the following IP address:

**IP address:** 192.168.10.101      **Subnet mask:** 255.255.255.0

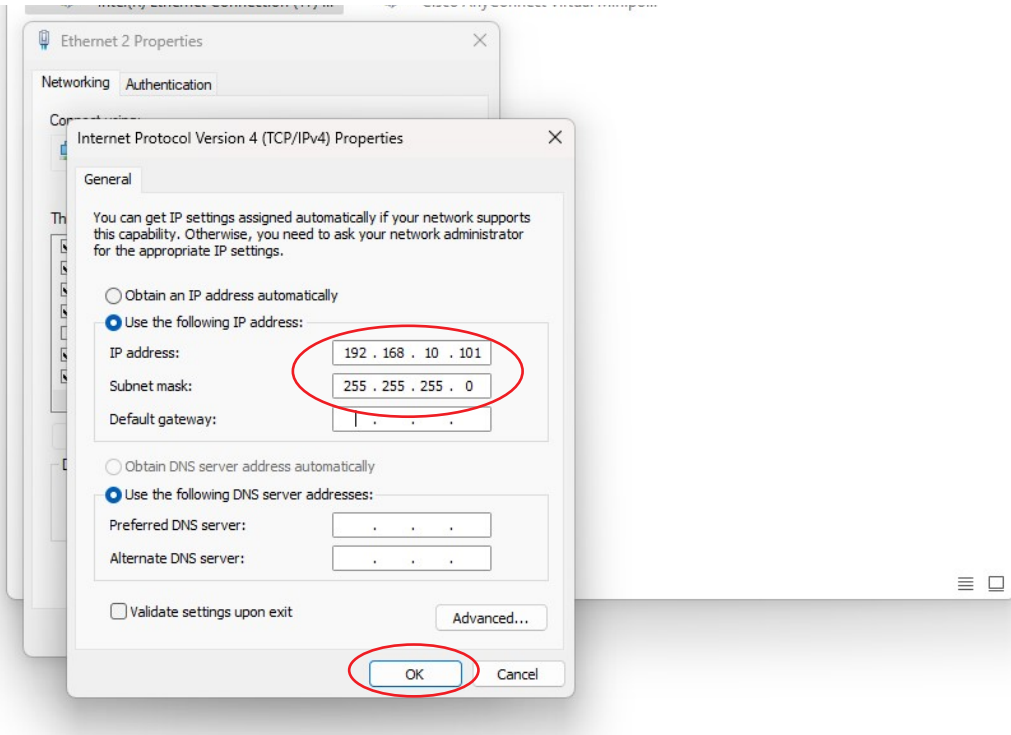

10. Click OK. Close the rest of the dialog boxes.  
11. Open the Chrome™ or Edge® web browser.  
12. In the address bar type the following address: <http://192.168.10.100>. Press Enter.

13. This will bring up the DCX Web Page interface.
14. Enter a user ID number (any number up to 9 digits long).

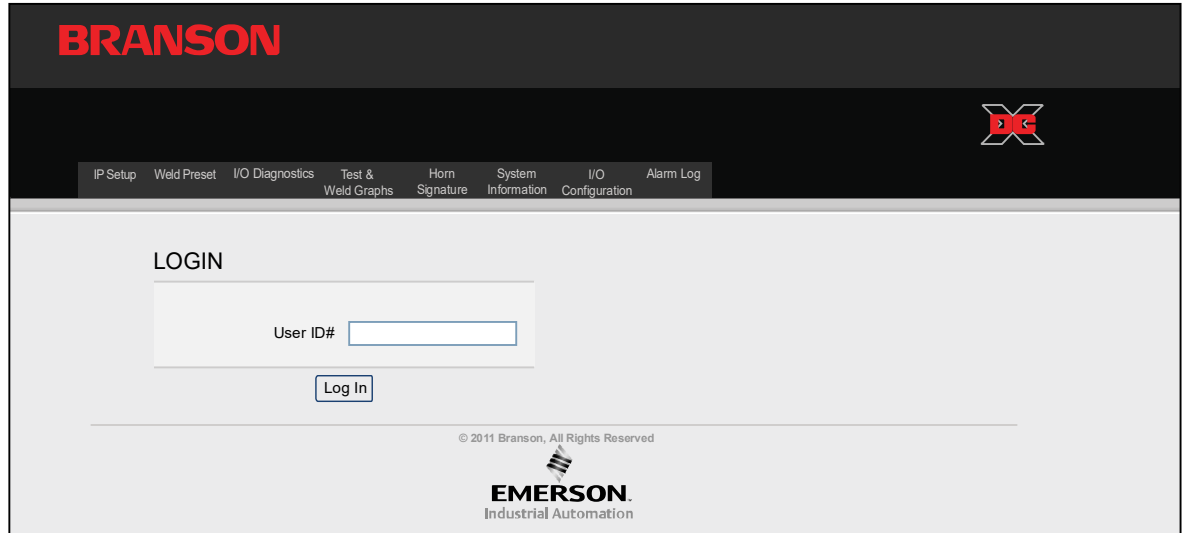



### 6.6.3 Using the Web Page Interface

For complete instructions detailing the web page interface consult the DCX Series Web Page Interface Instruction Manual (4000843).

## 6.7 Ultrasonics Test Procedure

The Ultrasonics Test function measures ultrasonic power dissipated by the ultrasonic stack with no load. Autotune with Memory (ATM) function ensures that the power supply does not require any manual adjustments. The ultrasonics test procedure involves an automatic matching of the frequency of the power supply to the frequency of the converter-booster-horn (stack).

WARNING	General Warning
	<ul style="list-style-type: none"> <li>• Ensure that no one is in contact with the horn when testing the power supply</li> <li>• Do not cycle the welding system if either the RF cable or converter is disconnected</li> </ul>

CAUTION	General Warning
	<p>Ensure the power supply is properly connected, as indicated in <a href="#">4.3 Installation Steps</a>.</p>

### 6.7.1 Using the Front Panel Controls

**Table 6.7** Power Supply Ultrasonic Test Procedure (Front Panel)

Step	Action	Reference
1	Turn on the power supply. The front panel Power LED and LCD turn on.	 <p>Power On LED</p>

**Table 6.7** Power Supply Ultrasonic Test Procedure (Front Panel)

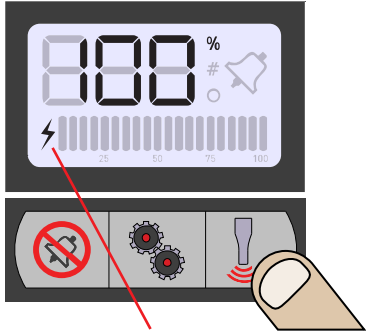
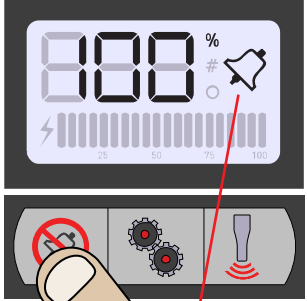
Step	Action	Reference
2	Press the Test key for 1-2 seconds, then release. The Sonics Active indicator appears while the Test key is pressed. If the power supply alarm indicator does not appear, the test procedure is finished.	 <p>Sonics Active Indicator</p>
3	If the alarm indicator appears, press the Alarm Reset key and repeat step 2 one time only. If the alarm persists, refer to <a href="#">7.6 Troubleshooting</a> .	 <p>Alarm Indicator</p>

## 6.7.2 Using the I/O Connections

**Table 6.8** Power Supply Ultrasonic Test Procedure (User I/O)

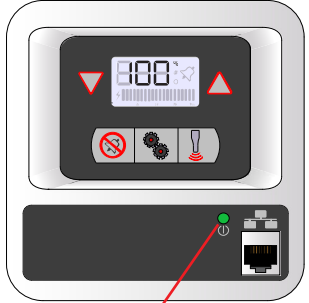
Step	Action	Reference
1	Wire the necessary I/O signals as shown on <a href="#">Figure 6.5</a> , or using a similar setup.	Refer to <a href="#">Figure 6.5</a> below.
2	Turn on the power supply. The front panel Power LED should turn on. Ready Signal should become active.	 <p>Power On LED</p>

**Table 6.8** Power Supply Ultrasonic Test Procedure (User I/O)

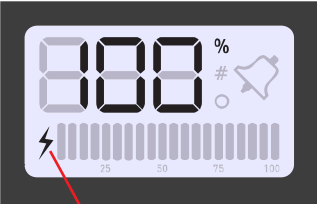
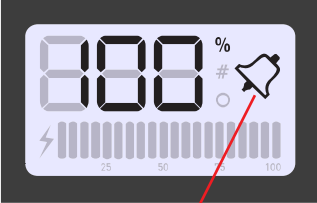
Step	Action	Reference
3	Send an External Start signal for 1-2 seconds. The Sonics Active output will become active and the Sonics Active indicator appears while the External Start Signal is present. If the General Alarm output/ alarm indicator do not become active, the test procedure is finished.	 <p data-bbox="1073 520 1344 548">Sonics Active Indicator</p>
4	If the General Alarm output/alarm indicator become active, send an External Reset signal and repeat step 2 one time only. If the alarm persists, refer to <a href="#">7.6 Troubleshooting</a> .	 <p data-bbox="1117 802 1300 829">Alarm Indicator</p>

**Figure 6.5** Test Connections.

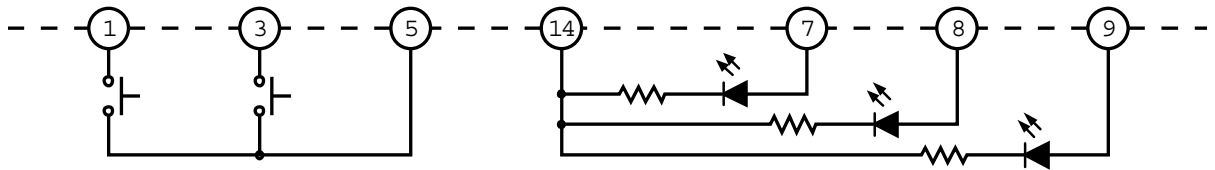

**Table 6.9** Test Connections

Item	Description
1	External Start
3	External Reset
5	+ 24 VDC
7	Ready Signal
8	Sonics On
9	General Alarm
14	+ 24 V Return

### 6.7.3 Using the Web page interface

**Table 6.10** Power Supply Ultrasonic Test Procedure

Step	Action
1	Turn on the power supply. The front panel Power LED should turn on.
2	Connect to the DCX Web Page Interface. See <a href="#">6.6.2 Connecting to the Web Page Interface</a> .
3	Go to the <b>Test &amp; Weld Graphs</b> tab. Press the <b>Start Test</b> button to start the test. Sonics will become active and the button will change to <b>Stop Test</b> . Press the button again to stop the test.  If the <b>OK - Memory Stored</b> indicator becomes active the test procedure is finished.  Low level ultrasonic energy will remain active until the <b>Stop Test</b> button is pressed. If you close the web browser, ultrasonic energy will turn off automatically after 5 seconds.
4	If the <b>Overload - Memory Cleared</b> indicator becomes active the test will be interrupted, press the <b>Reset Overload</b> button and repeat step 3 one time only. If the alarm persists, refer to <a href="#">7.6 Troubleshooting</a> .



---

## **Chapter 7: Maintenance**

---

<b>7.1</b>	<b>General Maintenance Considerations . . . . .</b>	<b>94</b>
<b>7.2</b>	<b>DCX S-Series Preventive Maintenance . . . . .</b>	<b>95</b>
<b>7.3</b>	<b>Calibration . . . . .</b>	<b>100</b>
<b>7.4</b>	<b>Recommended Spare Stock . . . . .</b>	<b>101</b>
<b>7.5</b>	<b>Circuit Diagram. . . . .</b>	<b>105</b>
<b>7.6</b>	<b>Troubleshooting . . . . .</b>	<b>106</b>
<b>7.7</b>	<b>Cold Start Procedure . . . . .</b>	<b>110</b>

## 7.1 General Maintenance Considerations

WARNING	General Warning
	<p>Power supplies produce high voltage. To avoid the possibility of an electrical shock, you should always power down your system prior to repairing any portion of it.</p>

CAUTION	General Warning
	<p>When performing maintenance on the welder, make sure that no other automated systems are active.</p>

NOTICE	
	<p>There are no customer replaceable components inside the power supply. Have all servicing done by a qualified Branson technician.</p> <p>When returning printed circuit boards, make sure to enclose them in an anti-static package.</p> <p>Connectors may not be keyed and wires may not be color-coded. Therefore, when disconnecting cables and wires, label them so you can reconnect them properly.</p> <p>To prevent circuit damage from electrostatic discharge, always service the power supply on a static-dissipative surface, while wearing a properly grounded wrist strap.</p>

NOTICE	
	<p>When the battery is worn out, dispose it under the ordinance of each local government.</p>

## 7.2 DCX S-Series Preventive Maintenance

The following preventive measures help assure long term operation of your Branson DCX S-Series equipment.

### 7.2.1 Periodically Clean the Equipment

NOTICE	
	<p>Use only antistatic vacuum cleaners to prevent damage from electrostatic discharge to your power supply.</p>

Air is continuously drawn into the power supply. Periodically disconnect the unit from power, remove the cover and vacuum out any accumulated dust and debris. Remove material adhering to:

- the fan blades and motor
- power supply heat sink cooling fins
- transformers
- circuit boards
- cooling intake vents
- exhaust ports

External covers may be cleaned with a damp sponge or cloth using a solution of mild soap and water. Do not allow cleaning solution to enter the unit.

To prevent rust in areas of high humidity, exposed steel surfaces, may require a very light film of rust preventing oil, such as WD-40<sup>®1</sup>.

### 7.2.2 Recondition the Stack (Converter, Booster, and Horn)

NOTICE	
	<p>Never clean the converter-booster-horn stack mating surfaces by using a buffing wheel or by filing.</p>

Welding system components work most efficiently when the converter-booster-horn stack mating surfaces are flat, in solid contact, and free from fretting corrosion. Poor contact between mating surfaces wastes power output, makes tuning difficult, increases noise and heat, and may cause damage to the converter.

1. WD-40 is a registered trademark of WD-40 Manufacturing Company.

For standard 20 kHz products, a Branson Mylar® polyester film washer should be installed between the horn and booster, and horn and converter. Replace the washer if torn or perforated. Stacks using Mylar® plastic film washers should be inspected every three months.

Stacks used with silicone grease, as with certain 20 kHz, and all 40 kHz products, should be periodically reconditioned to eliminate fretting corrosion. A stack using silicone grease should be inspected every two weeks for corrosion. When experience is gained for specific stacks, the inspection interval can be adjusted to a longer or shorter period as required.

### 7.2.2.1 Stack Reconditioning Procedure

To recondition stack mating surfaces, take the following steps.

**Table 7.1** Stack Reconditioning Procedure

Step	Action
1	Disassemble the converter-booster-horn stack and wipe the mating surfaces with a clean cloth or paper towel.
2	Examine all mating surfaces. If any mating surface shows corrosion or a hard, dark deposit, recondition it.
3	If necessary, remove the threaded stud from the part.
4	Tape a clean sheet of #400 (or finer) grit emery cloth to a clean, smooth, flat surface (such as a sheet of plate glass), as in <a href="#">Figure 7.1</a> .
5	Place the interface surface on the emery cloth. Grasp the part at the lower end, with your thumb over the spanner-wrench hole, and lap the part in a straight line across the emery cloth. Do not apply downward pressure — the weight of the part alone provides sufficient pressure.
6	Lap the part, two or three times, in the same direction against the emery cloth. (See <a href="#">Figure 7.1</a> ).
7	Rotate the part 120 degrees, placing your thumb over the spanner-wrench hole, and repeat the lapping procedure in step 6.
8	Rotate the part another 120 degrees to the next spanner-wrench hole, and repeat the lapping procedure in step 6.
9	Re-examine the mating surface. If necessary, repeat steps 2-5 until you remove most of the contaminant. Remember, this should not require more than two to three complete rotations for an aluminum horn or booster; a titanium component may require more rotations.
10	<p>Before re-inserting a threaded stud in an aluminum booster or horn:</p> <ul style="list-style-type: none"> <li>Using a file card or wire brush, clean any aluminum bits from the knurled end of the stud</li> <li>Using a clean cloth or towel, clean the threaded hole</li> <li>Examine the knurled end of the stud. If worn, replace the stud. Also, examine the stud and threaded hole for stripped threads</li> </ul> <p>Threaded studs cannot be reused in titanium horns or boosters. Replace all studs in these components.</p>
11	Assemble and install the stack.

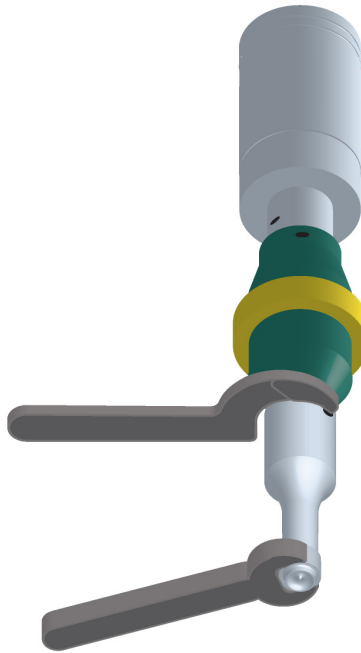
**Figure 7.1** Reconditioning Stack Mating Surfaces**Table 7.2** Reconditioning Stack

Item	Description
1	Tape
2	#400 Emery Cloth

### 7.2.2.2 Stack Reassembly Process

**Table 7.3** Stack Torque Values

Frequency	Torque
20 kHz	220 in·lb (24.85 N·m)
40 kHz	95 in·lb (10.73 N·m)

## For a 20 kHz System

**Table 7.4** Stack Reassembly Steps for a 20 kHz System

Step	Action
1	Clean the mating surfaces of the converter, booster, and horn. Remove any foreign material from the threaded holes.
2	Install the threaded stud into the top of the booster. Torque to 450 in·lb (50.84 N·m). If the stud is dry, apply 1 or 2 drops of a light lubricating oil before installing.
3	Install the threaded stud into the top of the horn. Torque to 450 in·lb (50.84 N·m). If the stud is dry, apply 1 or 2 drops of a light lubricating oil before installing.
4	Install a single Mylar <sup>®</sup> plastic film washer (matching the size of the washer to the stud) to each interface.
5	Assemble the converter to the booster and the booster to the horn.
6	Torque to 220 in·lb (24.85 N·m) at each interface.

## For a 40 kHz System

**Table 7.5** Stack Reassembly Steps for a 40 kHz System

Step	Action
1	Clean the mating surfaces of the converter, booster, and horn. Remove any foreign material from the threaded holes.
2	Apply a drop of Loctite <sup>®a</sup> 290 threadlocker (or equivalent) to the studs for the booster and horn.
3	Install the threaded stud into the top of the booster. Torque to 70 in·lb (7.91 N·m). Remove excess Loctite 290 threadlocker from the booster face and let cure for 30 minutes.
4	Install the threaded stud into the top of the horn. Torque to 70 in·lb (7.91 N·m). Remove excess Loctite 290 threadlocker from the horn face and let cure for 30 minutes.
5	Coat each interface surface with a thin film of silicon grease - <i>but do not apply silicon grease to a threaded stud or tip.</i>
6	Torque to 95 in·lb (10.73 N·m) at each interface.

a. Loctite is a registered trademark of Henkel Corporation, U.S.A.

**Table 7.6** Stud Torque Values

Used on	Stud Size	Torque	EDP #
20 kHz	1/2 in x 20 x 1-1/4 in	450 in·lb, 50.84 N·m	100-098-370
	1/2 in x 20 x 1-1/2 in		100-098-123
40 kHz <sup>a</sup>	M8 x 1.25	70 in·lb, 7.91 N·m	100-098-790

a. Add a drop of Loctite 290 threadlocker to the stud. Torque and let cure for 30 minutes before using.

### 7.2.3 Routine Component Replacement

The lifetime of certain parts is based on the number of cycles the unit has completed, or on hours of operation. Change cooling fans at 20,000 hours, and filter kits as required.

## **7.3 Calibration**

This product does not normally require scheduled calibration. However, if you are operating under any type of regulatory requirements, you may need to calibrate the equipment according to that schedule and set of standards. Contact Branson for details.

## 7.4 Recommended Spare Stock

This section provides lists of replacement parts, system cables, and suggested spares.

### 7.4.1 System Cables

You can order the following cables:

**Table 7.7** DCX S-Series System Cables

P/N	Description for Manual
100-240-383	Cable, RF 8 ft (2.5 m)
100-240-384	Cable, RF 15 ft (4.5 m)
100-240-385	Cable, RF 25 ft (7.5 m)
100-240-386	Cable, RF 50 ft (15 m)
100-240-387	Cable, RF right angle 8 ft (2.5 m)
100-240-388	Cable, RF right angle 15 ft (4.5 m)
100-240-389	Cable, RF right angle 25 ft (7.5 m)
100-240-390	Cable, RF right angle 50 ft (15 m)
100-240-392	Cable, User I/O 25 ft (7.5 m)
100-240-393	Cable, User I/O 50 ft (15 m)
200-240-396	Cable Ethernet Cat 5e 7 ft (2.1 m)
100-246-1625	Line Cord DCX 120V 15A (NEMA 5-15P)
100-246-1646	Line Cord DCX 120V 20A (NEMA 5-20P)

### 7.4.2 Suggested Spares

**Table 7.8** Suggested Spares

Description	EDP#	1-4 Units	6-12 Units	14+ Units
Converter	Refer to <a href="#">Table 7.9</a>	0	1	2
Booster	Refer to <a href="#">Table 7.10</a>	0	1	2
Horn	As Ordered	1	1	2
Studs	Refer to <a href="#">Table 7.11</a>	4	6	8
Mylar <sup>®</sup> Plastic Film Washer Kit	Refer to <a href="#">Table 7.11</a>	1	1	1

**Table 7.9** Converters Compatible with the DCX S-Series 120V Power Supply

Where Used	Model	Connector	Part Number
20 kHz / 1250 W	CR-20S	SHV connector	125-135-115R
	CR-20C	SHV connector with 3 ft (0.9 m) cable	159-135-210R
	CH-20 (932 AH SPL)	SHV connector	159-135-075R
	CH-20C	SHV connector with 3 ft (0.9 m) cable	159-135-211R
	CS-20S	SHV connector	159-135-138R
	CS-20C	SHV connector with 3 ft (0.9 m) cable	159-135-209R
40 kHz / 400 W 40 kHz / 800 W	4TP	SHV connector (platen mount)	101-135-068R
	CR-40S (4TH)	SHV connector	101-135-067R
	CR-40C	SHV connector with 3 ft (0.9 m) cable	159-135-215R

**Table 7.10** DCX S-Series Compatible Boosters

Type of Booster	Description	Part Number
Solid Mount (1/2-20 horn stud) 20 kHz	Titanium, 1:0.6 (Purple)	101-149-095
	Titanium, 1:1 (Green)	101-149-096
	Titanium, 1:1.5 (Gold)	101-149-097
	Titanium, 1:2 (Silver)	101-149-098
	Titanium, 1:2.5 (Black)	101-149-099
Solid Mount (M8 x 1.25 horn stud) 40 kHz	Titanium, 1:0.6 (Purple)	109-041-178
	Titanium, 1:1 (Green)	109-041-177
	Titanium, 1:1.5 (Gold)	109-041-176
	Titanium, 1:2 (Silver)	109-041-175
	Titanium, 1:2.5 (Black)	109-041-174

**Table 7.10** DCX S-Series Compatible Boosters

Type of Booster	Description	Part Number
Standard Series (1/2-20 horn stud) 20 kHz	Aluminum, 1:0.6 (Purple)	101-149-055
	Aluminum, 1:1 (Green)	101-149-051
	Aluminum, 1:1.5 (Gold)	101-149-052
	Aluminum, 1:2 (Silver)	101-149-053
	Titanium, 1:0.6 (Purple)	101-149-060
	Titanium, 1:1 (Green)	101-149-056
	Titanium, 1:1.5 (Gold)	101-149-057
	Titanium, 1:2 (Silver)	101-149-058
	Titanium, 1:2.5 (Black)	101-149-059
Standard Series (M8 x 1.25 horn stud) 40 kHz	Aluminum, 1:0.6 (Purple)	101-149-087
	Aluminum, 1:1 (Green)	101-149-079
	Aluminum, 1:1.5 (Gold)	101-149-080
	Aluminum, 1:2 (Silver)	101-149-081R
	Aluminum, 1:2.5 (Black)	101-149-082
	Titanium, 1:1 (Green)	101-149-085
	Titanium, 1:1.5 (Gold)	101-149-086
	Titanium, 1:2 (Silver)	101-149-083
	Titanium, 1:2.5 (Black)	101-149-084

**Table 7.11** Other Items used with the DCX-S Series Power Supply

Product	Description	Part No.
Silicone grease	For use with 40 kHz systems	101-053-002
Mylar® Plastic Film Washers (for 20 kHz systems)	Kit, 10 each (1/2 in. and 3/8 in.)	100-063-357
	Kit, 150 each (1/2 in.)	100-063-471
	Kit, 150 each (3/8 in.)	100-063-472
Tool Kit	20 kHz (spanner wrench and 10 pc washer kit)	101-063-208R
	40 kHz (spanner wrench and silicone grease)	101-063-176R
Spanner wrench	20 kHz	101-118-039
	40 kHz	201-118-024

**Table 7.11** Other Items used with the DCX-S Series Power Supply

<b>Product</b>	<b>Description</b>	<b>Part No.</b>
Studs	1/2-20 x 1-1/4 (titanium horns)	100-098-370
	1/2-20 x 1-1/2 (aluminum horns, 20 kHz boosters)	100-098-123
	M-8 x 1.25 (40 kHz horns and boosters)	100-098-790
Fan Filter <sup>a</sup>	Kit Fan Filter 92mm	101-063-934

a. When using a fan filter on DCX power supplies, the maximum output power must be derated by 10%.

## 7.5 Circuit Diagram

Figure 7.2 Interconnect Diagram, Power Supply

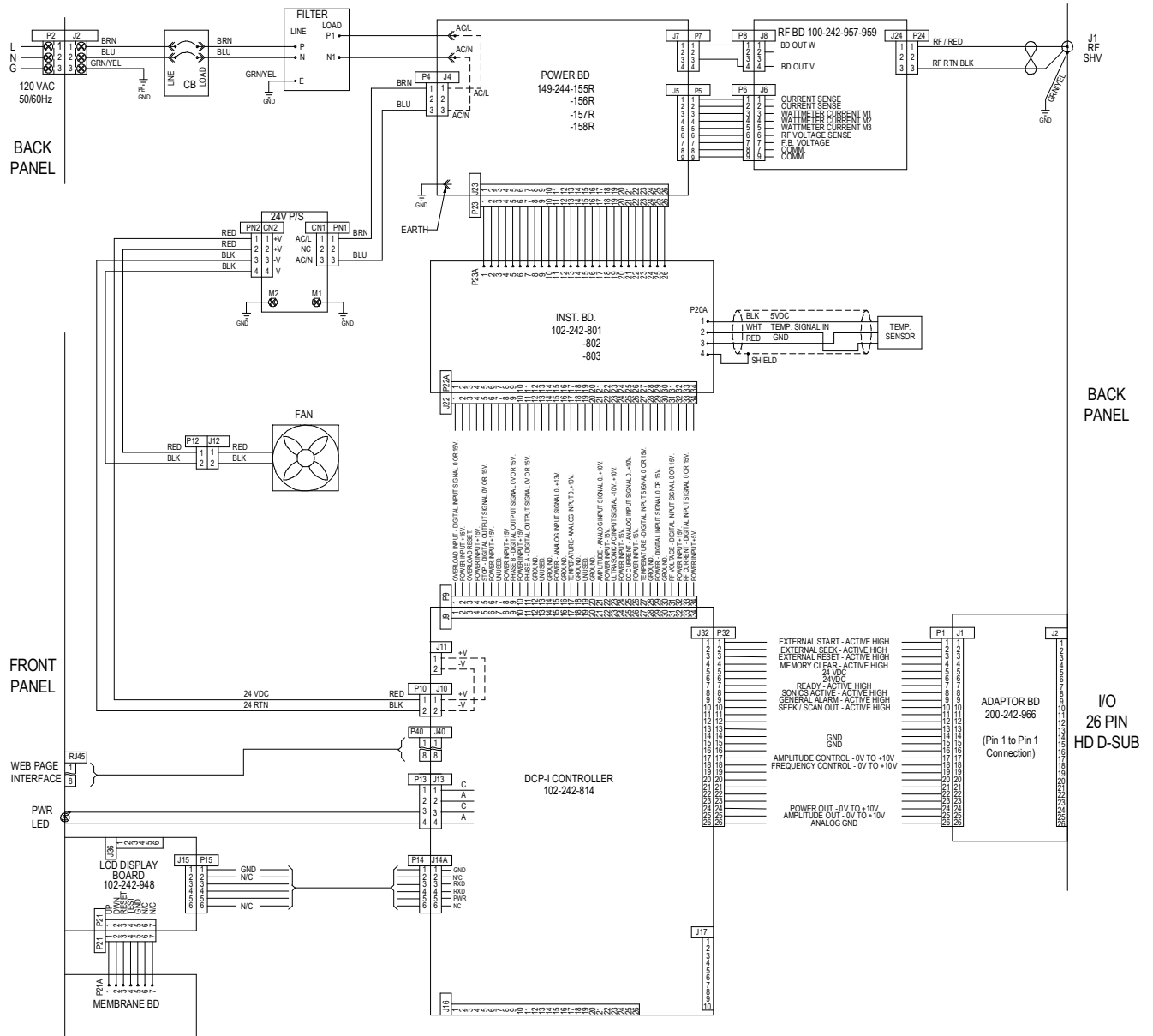

## 7.6 Troubleshooting

If you have a problem operating the DCX S-Series Power Supply, take the following steps:

**Table 7.12** Troubleshooting

Step	Action
1	Make sure the converter-booster-horn stack is properly assembled and installed.
2	For instructions on reconditioning stack component surfaces, refer to <a href="#">7.2.2 Recondition the Stack (Converter, Booster, and Horn)</a> .
3	If you need additional help, refer to <a href="#">Chapter 1: Safety and Support 1.4 How to Contact Branson</a> which lists procedures for contacting Branson, obtaining replacement parts, and returning equipment.

NOTICE	
	DCX S-Series Power Supplies should be serviced only by qualified technicians using Branson-approved test and repair equipment, repair procedures, and replacement parts. Unauthorized attempts at repair or modification of the power supply will void the warranty.

### 7.6.1 Common Electrical Problems

NOTICE	
	If the circuit breaker fails more than once, this usually indicates that another component has failed. Continue troubleshooting other components.

**Table 7.13** Troubleshooting Common Electrical Problems

Problem	Check	Solution
Main circuit breaker trips when plugging the power supply into an electrical outlet.	Inspect line connection cables.	If failed, replace.
Main circuit breaker trips during weld cycle.	Check current rating of the main circuit breaker.	If failed, replace.
Main circuit breaker fails during power up.	Check main circuit breaker current rating.	If incompatible, replace main circuit breaker.

**Table 7.13** Troubleshooting Common Electrical Problems

Problem	Check	Solution
When touching a component of the weld system, you get a slight electrical shock.	Ensure the Ground cable is connected properly.	N/A
	Inspect the line cables.	If failed, repair or replace.

## 7.6.2 Fan/Power Switch Problems

NOTICE	
	If the circuit breaker fails more than once, this usually indicates that another component has failed. Continue troubleshooting other components.

**Table 7.14** Troubleshooting Fan/Power Switch Problem

Problem	Check	Solution
Fan does not work; power indicator light is on.		Send unit for repair.
Fan does not work; Power indicator does not light when Power switch is on.	Make sure power supply is plugged into main power.	If power is available and unit fails to work, send the unit for repair.
	Test Power On/Off Switch (power supply circuit breaker).	Send unit for repair.

## 7.6.3 Ultrasonic Power Problems

**Table 7.15** Troubleshooting Ultrasonic Power Problems

Problem	Check	Solution
Ultrasonic power delivered to horn; no indication on bar graph.	Check connector cables, replace if failed.	Replace defective cables.
	Test power supply.	See <a href="#">Chapter 6: Operation 6.7 Ultrasonics Test Procedure</a> .

**Table 7.15** Troubleshooting Ultrasonic Power Problems

Problem	Check	Solution
No ultrasonic power generated when Test key pressed; no Alarm indicator.	Failed or missing stack.	Replace.
	RF cable unplugged or failed; replace if failed.	Plug in or replace.
	Test power supply ( <a href="#">Chapter 6: Operation 6.7 Ultrasonics Test Procedure</a> ).	If defective, send unit for repair.
Unable to adjust amplitude using the front panel keypad.	Register setting configured to "External Amplitude Control".	Reset if required. See <a href="#">Chapter 6: Operation 6.4 Configuring the Power Supply Registers</a> .
Unable to remote control.	User I/O cable.	Repair or replace.
	Customer's switching device.	Test/inspect/repair/replace.

## 7.6.4 Weld Cycle Problems

**Table 7.16** Troubleshooting Weld Cycle Problems

Problem	Check	Solution
Full ultrasonic power not delivered.	Unsuitable horn or booster selection.	Contact Branson Applications Lab
	Plastic part material varies.	
	Mold release lubricant in weld area.	
	Unsuitable joint design.	
	Unsuitable or misaligned part fixture.	
	Amplitude setting.	Adjust if required.
No ultrasonic power passed to horn.	Power supply overheating; check fan and vents.	Replace improperly operating fan. Remove dust and debris.

**Table 7.16** Troubleshooting Weld Cycle Problems

Problem	Check	Solution
Alarm indicator illuminates when you press the Test key or during the weld cycle.	Check converter-booster-horn stack interface for fretting corrosion.	See <a href="#">7.2.2 Recondition the Stack (Converter, Booster, and Horn)</a> .
	Check for loose or failed horn converter or booster.	Tighten or replace as needed.
	Check for loose or failed horn or booster stud.	
	Failed RF cable.	Replace if failed.
Excessively warm horn, booster, and converter; occasional overloads.	Check converter-booster-horn stack mating surfaces for fretting corrosion.	See <a href="#">7.2.2 Recondition the Stack (Converter, Booster, and Horn)</a> .
	Be certain proper cooling has been provided.	Replace fan if required.

## 7.7 Cold Start Procedure

The power supply internal memory stores the system default settings and the registers that you set. It also provides temporary storage to support the power supply internal functions. A cold start clears the Amplitude Setting, the user I/O configuration, the IP address, and restores them to original factory defaults. It is not necessary to perform a cold start during normal operation and servicing, but you might find a cold start helpful when:

- You suspect the system is not operating properly
- You want to make a new setup

Some system memory registers, such as Software version, will not be cleared by this Cold Start procedure.

### 7.7.1 Performing a Cold Start

NOTICE	
	<p>Using the Cold Start procedure will erase the current Amplitude Setting, the IP address and some of the Registers that you set. Be sure you have a record of your setup if you want to retain it.</p>

**Table 7.17** Steps to Perform a Cold Start.

Step	Action
1	Turn off the power supply.
2	Connect together pins 4 and 10 on the 26-pin User I/O Connector.
3	Turn on the power supply.
4	After the power up sequence ends, turn off the power supply.
5	Disconnect pins 4 and 10 of the 26-pin on User I/O Connector.

---

# **Appendix A: Signal Diagrams**

---

**A.1 Signal Diagrams ..... 112**

## A.1 Signal Diagrams

Figure A.1 Continuous Mode

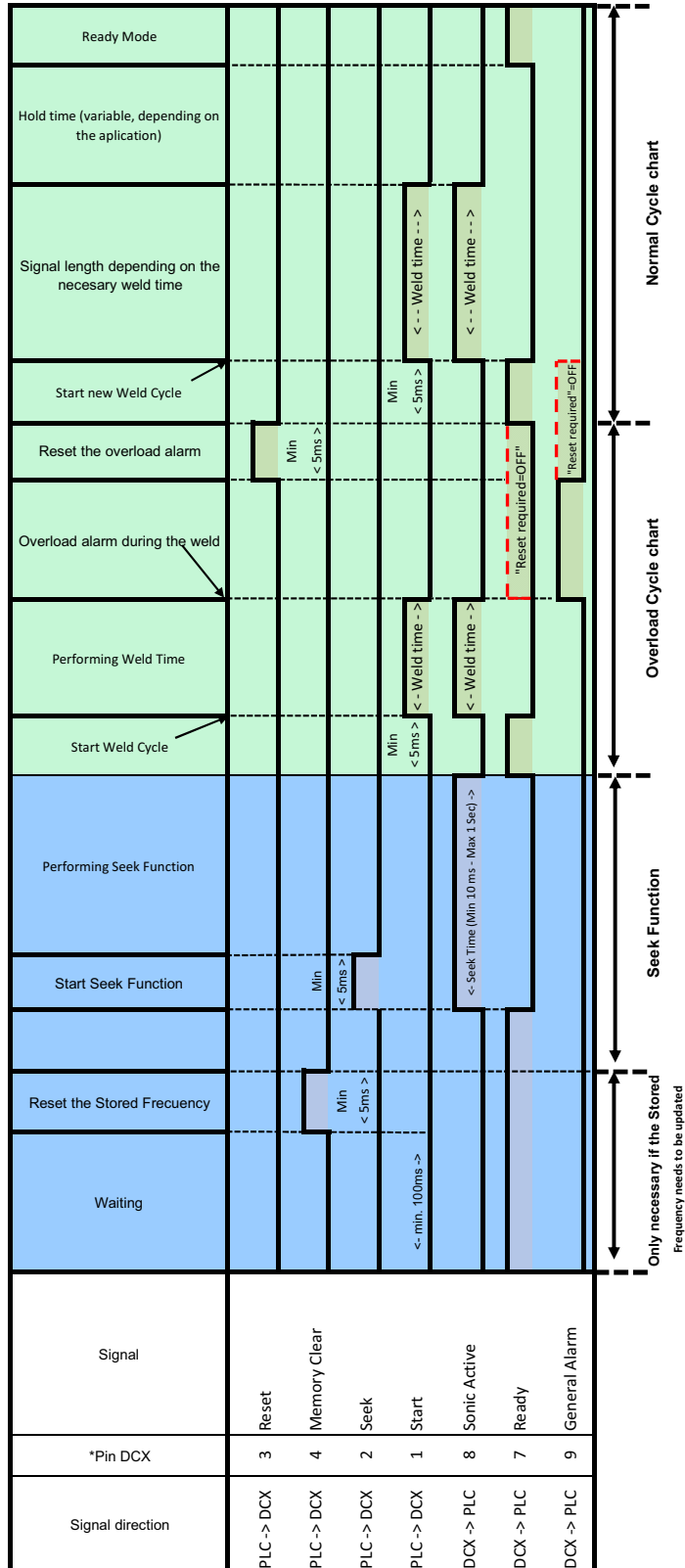

\*Inputs/Outputs are configurable on the User I/O Configuration webpage.

--- If Reset Required is unchecked for Overload in Alarm Webpage interface, Ready signal will be enabled after Start switch is released.

---

## **Appendix B: Manual's Revisions**

---

**B.1 Manual's Revisions . . . . . 114**

## B.1 Manual's Revisions

Refer to the table below for the appropriate manual revision depending on your Power Supply's manufacturing date.

**Table B.1** Manual's Revisions

Manual's Revisions	Power Supply's Manufacturing Date	
	From	To
00	April 2022	July 2022
01	August 2022	March 2026
02	April 2026	To date

**Figure B.1** Manufacturing date on the Information label



**MODEL: 4.00DCXv20HOR**  
**EDP NO.: 101-132-1838**  
 SERIAL NO.: DJD21064185F



INPUT1:200-240VAC~25A, 50/60Hz 1Ø  
 INPUT 2:24VDC 2.5A  
 MAX PWR: 4000W

MFG. DATE  
June 2021

**MADE IN MEXICO**  **EMERSON**

SERIAL NUMBER: XXXXXYYMM#####



1. Prefix
2. Year of Manufacture
3. Month of Manufacture
4. Incremental Serial Number

**Figure B.2** Location of the Information label on the back of the DCX S Power Supply Horizontal

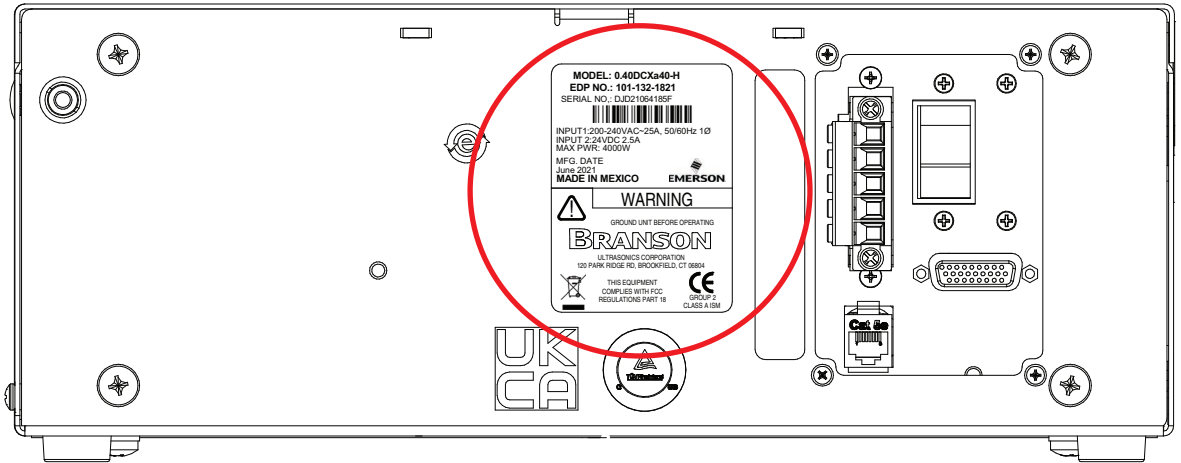

**Figure B.3** Location of the Information label on the top of the DCX S Power Supply Vertical

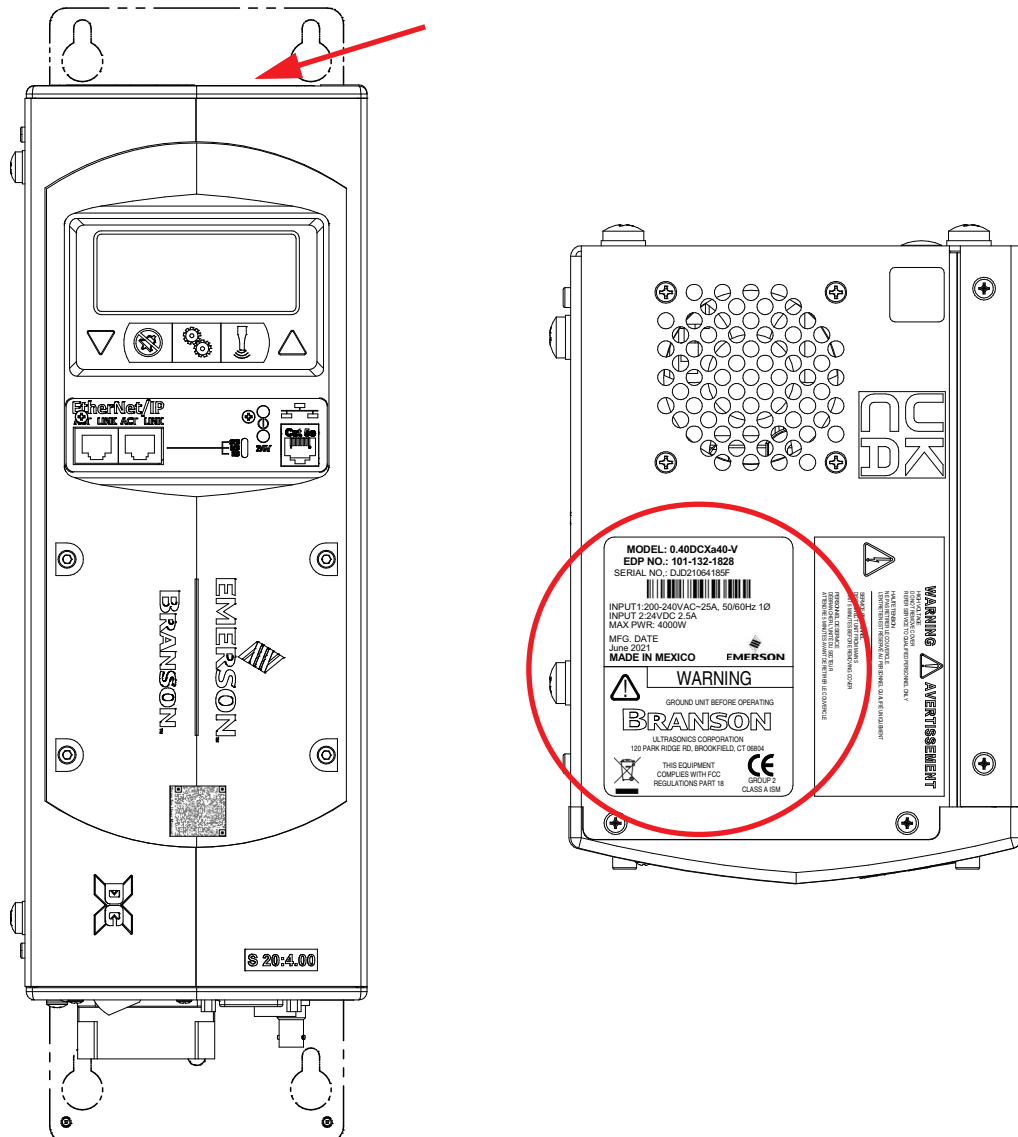



---

# Index

---

## A

- about Installation 36
- actuator 26
- alarm 26
  - configuring 50
  - latching 50
  - modes 50
- alarms
  - latching 79
- amplitude 80
  - controlling 50
  - definition 26
  - external control 26
  - start ramp 20, 50, 79
- amplitude control 50
- applications 25
- autotune with memory (AT/M) 16

## B

- bar graph 23, 81
  - frequency interpretation 82
  - power interpretation 81
  - setup 79
- bend radius 39
- booster 21, 26
  - clamp ring 51
  - dimensions 64
- Branson
  - how to contact 10

## C

- cables
  - bend radius 39
  - RF 47
  - user I/O 41
- clamping force 26
- cold start 110
- components
  - functional description 71
- connecting tip to horn 53
- connection
  - input power 48
  - user I/O 41
- connector
  - line 24
  - RF 24
  - user I/O 24
- controls, front panel 22
- converter 21, 26, 71

- cooling 55
- dimensions 64
- counters 26
- D**
- degating 26
- DHCP setting 80
- drop test 30
- E**
- energy director 26
- environmental
  - requirements 38
  - specifications 30
- external
  - amplitude control 26
  - frequency control 26
- F**
- fixture 26
- flash 26
- force 26
- forming 26
- frequency 26
  - end of weld store 50, 79
  - external control 26
  - offset 17, 26, 79
  - seek 27
- frequency offset
  - definition 20
  - setup 50
- G**
- gain 26
- ground screw 24
- H**
- handling and unpacking 34
- horn 21, 26
  - amplitude 26
  - scan 26
  - scan, power-on 79
  - signature, definition 20
- how to contact Branson 10
- humidity 30, 38, 60
- I**
- indicators 22
- input
  - connection examples 47
- input power 47, 48
  - plug 48
  - ratings 38, 61
- inputs
  - analog 44
  - digital 43
- insertion 26
- installation 35
  - requirements 37
  - stack 56

- steps 39
- testing 56
- interface 26
- inventory of small parts 33
- IP address 79
- J**
- joint 27
- L**
- LCD
  - bar graph 81
    - frequency interpretation 82
    - power interpretation 81
    - setup 79
  - board 64
  - description 23
  - software version 79
  - viewing angle 40
- line input
  - connector 24
- line regulation 16
- load regulation 16
- M**
- maintenance 93
  - general considerations 94
- manual set 17
- Mylar plastic washers 51
- O**
- operation 73
  - principle of 25
- output
  - connection examples 47
- output circuit 64
- output power cable 47
- outputs
  - analog 45
  - digital 44
- P**
- parameter 27
- parts lists 101
- periodic and preventive maintenance
  - periodically clean the equipment 95
  - recondition the stack 95
  - routine component replacement 101
- Point to Point Connection
  - Windows 10 or Windows 11 84
- power
  - switch 24
- power supply
  - amplitude control 26
  - block diagram 63
  - circuit diagram 105
  - configuring 78
  - connections 24
  - continuous duty max. power 61

- cycle rate 61
- default settings (cold start) 110
- front panel controls 22
- manual set 16, 17
- models 16
- mounting 39
- power-on actions 79
- PVC materials, safety 7
- R**
- receiving the equipment 31
- restoring defaults 79
- returning equipment 34
- S**
- safety
  - cable detect 44
  - general precautions 5
  - maintenance 94
  - PVC materials 7
  - symbols, meaning 2
- seek 27
  - definition 20
  - power-on 79
  - ramp time 50
  - time 50, 79
  - timed 16, 50
- shipping and handling 30
- shock 30
- silicone grease 51
- solid mount boosters 72
- special cable requirements 39
- stack 21, 71, 72
- stack assembly 51
  - 20 kHz 53, 98
  - 30 kHz 53
  - 40 kHz 53
- staking 27
- support 57
- swaging 27
- system requirements, web page interface 84
- T**
- technical specifications 59
- temperature
  - ambient operating temperature 38, 60
  - shipping and storage 30, 60
- test, ultrasonic 22
- thermoplastic 27
- thermoset 27
- timed seek 16
- troubleshooting 106
  - electrical problems 106
  - fan/power switch problems 107
  - ultrasonic power 107
  - weld cycle problems 108

## **U**

- ultrasonic power 27
- ultrasonic stack 71
- ultrasonic welding 27
- unpacking 32

## **V**

- vibration 30

## **W**

- warranty 8
- Web Page Interface
  - Point to Point Connection
    - Windows 10 or Windows 11 84
- web page interface 17, 20, 84
- weld system 27
  - applications 25
- welding systems 25

