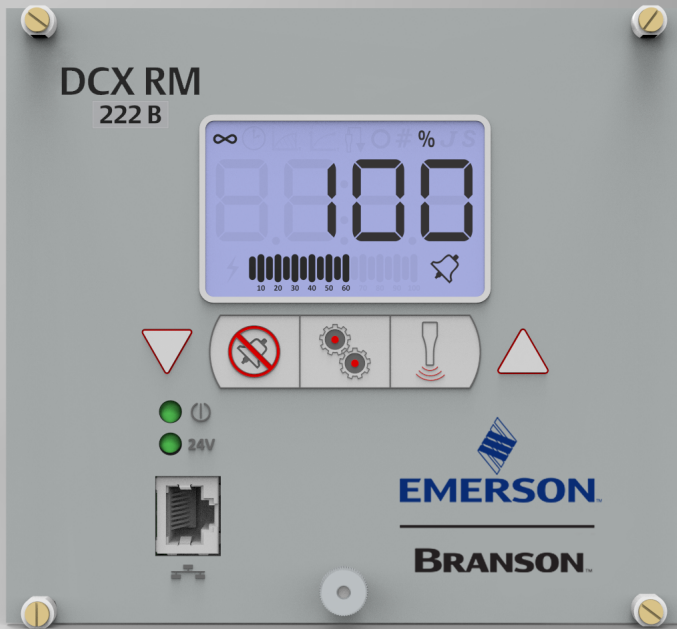




**EMERSON**<sup>TM</sup>

Original Instructions  
4000855 - REV. 01



# DCX RM B Power Supply

Digital Compact Basic Replacement

# Operating Manual

**Branson Ultrasonics Corp.**  
120 Park Ridge Road  
Brookfield, CT 06804  
(203) 796-0400  
<http://www.bransonultrasonics.com>

**BRANSON**

## Manual Change Information

At Branson, we strive to maintain our position as the leader in ultrasonics plastics joining, metal welding, cleaning and related technologies by continually improving our circuits and components in our equipment. These improvements are incorporated as soon as they are developed and thoroughly tested.

Information concerning any improvements will be added to the appropriate technical documentation at its next revision and printing. Therefore, when requesting service assistance for specific units, note the Revision information found on this document, and refer to the printing date which appears on this page.

## Copyright and Trademark Notice

Copyright © 2026 Branson Ultrasonics Corporation. All rights reserved. Contents of this publication may not be reproduced in any form without the written permission of Branson Ultrasonics Corporation.

Mylar is a registered trademark of DuPont Teijin Films.

Loctite is a registered trademark of Loctite Corporation.

WD-40 is a registered trademark of WD-40 Company.

Windows 10, Windows 11, and Microsoft Edge are registered trademarks of Microsoft Corporation.

Google Chrome is a trademark of Google LLC.

Other trademarks and service marks mentioned herein are held by their respective owners.

## Foreword

Congratulations on your choice of a Branson Ultrasonics Corporation system!

The Branson DCX RM B Power Supply system is process equipment for the joining of plastic parts using ultrasonic energy. It is the newest generation of product using this sophisticated technology for a variety of customer applications. This Operating Manual is part of the documentation set for this system, and should be kept with the equipment.

Thank you for choosing Branson!

## Introduction

This manual is arranged into several structured chapters which will help you find the information you may need to know to safely handle, install, set up, program, operate, and/or maintain this product. Please refer to the [Table of Contents](#) and/or the [Index](#) of this manual to find the information you may be looking for. In the event you require additional assistance or information, please contact our Product Support department (see [1.3 How to Contact Branson](#) for information on how to contact them) or your local Branson representative.



---

# Table of Contents

---

**Chapter 1: Safety and Support**

1.1 Safety Requirements and Warnings . . . . .	2
1.2 General Precautions . . . . .	6
1.3 How to Contact Branson . . . . .	9

**Chapter 2: Introduction**

2.1 Models Covered . . . . .	16
2.2 Compatibility with other Branson Products . . . . .	18
2.3 Features . . . . .	19
2.4 Controls and Indicators . . . . .	22
2.5 Welding Systems . . . . .	27
2.6 Glossary . . . . .	28

**Chapter 3: Delivery and Handling**

3.1 Shipping and Handling . . . . .	32
3.2 Receiving . . . . .	33
3.3 Unpacking the Power Supply . . . . .	34
3.4 Take Inventory of Small Parts . . . . .	35
3.5 Returning Equipment . . . . .	36

**Chapter 4: Technical Specifications**

4.1 Technical Specifications . . . . .	38
4.2 Physical Description . . . . .	40
4.3 EU Declaration of Conformity . . . . .	41
4.4 UK Declaration of Conformity . . . . .	42

**Chapter 5: Installation and Setup**

5.1 About Installation . . . . .	44
5.2 Installation Requirements . . . . .	45
5.3 Installation Steps . . . . .	50
5.4 Power Supply Configuration . . . . .	63
5.5 Assembling the Acoustic Stack . . . . .	64
5.6 Converter Cooling . . . . .	69
5.7 Testing the Installation . . . . .	71
5.8 Still Need Help? . . . . .	72

**Chapter 6: Converters and Boosters**

6.1 Converters and Boosters . . . . .	74
---------------------------------------	----

**Chapter 7: Operation**

7.1 Activating Ultrasonic Power . . . . .	86
7.2 Setting the Amplitude . . . . .	87
7.3 Resetting the Power Supply Alarms . . . . .	89
7.4 Configuring the Power Supply Registers . . . . .	90
7.5 LCD Bar-Graph . . . . .	94
7.6 Web Page Interface . . . . .	97
7.7 Ultrasonics Test Procedure . . . . .	101

## **Chapter 8: Maintenance**

8.1	General Maintenance Considerations . . . . .	106
8.2	Preventive Maintenance . . . . .	108
8.3	Calibration . . . . .	114
8.4	Recommended Spare Stock . . . . .	115
8.5	Troubleshooting . . . . .	121

## **Appendix A: Signal Diagrams**

A.1	Signal Diagrams . . . . .	126
-----	---------------------------	-----

## **Appendix B: Manual's Revisions**

B.1	Manual's Revisions . . . . .	130
-----	------------------------------	-----

# List of Figures

## Chapter 1: Safety and Support

Figure 1.1	Safety-related Labels found on the DCX RM B Power Supply. . . . .	4
Figure 1.2	Safety-related Labels found on the DCX RM B Power Supply. . . . .	5

## Chapter 2: Introduction

Figure 2.1	The DCX RM B Power Supply . . . . .	17
Figure 2.2	DCX RM B Power Supply Front Panel Controls and Indicators . . . . .	22
Figure 2.3	LCD Description . . . . .	24
Figure 2.4	DCX RM B Power Supply Back Panel . . . . .	26

## Chapter 3: Delivery and Handling

## Chapter 4: Technical Specifications

Figure 4.1	Declaration of Conformity. . . . .	41
Figure 4.2	UK Declaration of Conformity . . . . .	42

## Chapter 5: Installation and Setup

Figure 5.1	DCX RM B Power Supply Dimensional Drawing (Small) . . . . .	46
Figure 5.2	DCX RM B Power Supply Dimensional Drawing (Medium) . . . . .	47
Figure 5.3	DCX RM B Power Supply Dimensional Drawing (Large) . . . . .	48
Figure 5.4	LCD Viewing Angle . . . . .	51
Figure 5.5	DCX RM B Power Supply Connections . . . . .	52
Figure 5.6	User I/O Cable Identification and Wire Color Diagram . . . . .	54
Figure 5.7	Typical Digital I/O Wiring Examples . . . . .	60
Figure 5.8	Typical Analog I/O Wiring Examples. . . . .	60
Figure 5.9	RF Cable Connection . . . . .	61
Figure 5.10	Assembling the Acoustic Stack . . . . .	65
Figure 5.11	Connecting Tip to Horn . . . . .	68

## Chapter 6: Converters and Boosters

Figure 6.1	20 kHz typical Converter Dimensions. . . . .	75
Figure 6.2	20 kHz Booster Dimensions . . . . .	76
Figure 6.3	20 kHz Converter/Booster/Horn, Typical Dimensions . . . . .	77
Figure 6.4	30 kHz Converter Dimensions . . . . .	78
Figure 6.5	30 kHz Booster Dimensions . . . . .	79
Figure 6.6	30 kHz Converter/Booster/Horn, Typical Dimensions . . . . .	80
Figure 6.7	40 kHz Booster Dimensions . . . . .	81
Figure 6.8	40 kHz Converter/Booster/Horn, Typical Dimensions . . . . .	82

## Chapter 7: Operation

Figure 7.1	LCD at Power Up . . . . .	87
Figure 7.2	LCD when in External Amplitude Control Mode . . . . .	88
Figure 7.3	Test Connections. . . . .	103

## Chapter 8: Maintenance

Figure 8.1	Reconditioning Stack Mating Surfaces . . . . .	110
------------	--	-----

## Appendix A: Signal Diagrams

Figure A.1	Continuous . . . . .	126
------------	----------------------	-----

Figure A.2	Continuous, Overload Error . . . . .	127
<b>Appendix B: Manual's Revisions</b>		
Figure B.1	Manufacturing date on the Information label . . . . .	130
Figure B.2	Location of the Information label on the back of the DCX RM B Power Supply . . . .	131

# List of Tables

## Chapter 1: Safety and Support

Table 1.1	Authorized Service Center (North America)	9
Table 1.2	Authorized Service Centers (South America)	9
Table 1.3	Authorized Service Centers (Asia)	10
Table 1.4	Authorized Service Centers (Europe)	12

## Chapter 2: Introduction

Table 2.1	Models Covered in this manual	16
Table 2.2	Power Supply Compatibility with Branson Converters	18
Table 2.3	Control Features	19
Table 2.4	DCX RM B Power Supply Front Panel Controls and Indicators	22
Table 2.5	LCD Description	24
Table 2.6	Connections to the DCX RM B Power Supply	26
Table 2.7	Glossary	28

## Chapter 3: Delivery and Handling

Table 3.1	Shipping Specifications	32
Table 3.2	Inspect the power supply	33
Table 3.3	Unpacking the power supply	34
Table 3.4	Small Parts included (=x) Power Supply Assemblies	35
Table 3.5	DCX RM B Power Supply System Cables	35

## Chapter 4: Technical Specifications

Table 4.1	Environmental Specifications	38
Table 4.2	Electrical Input Operating Voltages	38
Table 4.3	Input Current and Fuse Specifications	39
Table 4.4	Continuous Duty Max. Power	39
Table 4.5	Dimensions and Weights of DCX RM B Power Supply	40

## Chapter 5: Installation and Setup

Table 5.1	Environmental Requirements	49
Table 5.2	Input Current and Circuit Breaker Specifications	49
Table 5.3	DCX RM B Power Supply Connections	52
Table 5.4	User I/O Cable Pin Assignments	55
Table 5.5	To Enable Frequency Out on pin 1	56
Table 5.6	Available Digital Input Functions	57
Table 5.7	Available Digital Output Functions	58
Table 5.8	Available Analog Input Functions	58
Table 5.9	Available Analog Output Functions	59
Table 5.10	RF Cable Connection	61
Table 5.11	Acoustic Stack Description	65
Table 5.12	Stack Torque Values	65
Table 5.13	Tools	66
Table 5.14	20 kHz System	67
Table 5.15	30 kHz System	67
Table 5.16	40 kHz System	67
Table 5.17	Tip to horn torque values	68
Table 5.18	Continuous Duty Max. Power & Full Power Duty Cycle	69
Table 5.19	Converter Cooling Procedure	70

## Chapter 6: Converters and Boosters

Table 6.1	20 kHz Converter . . . . .	75
Table 6.2	20 kHz Booster. . . . .	76
Table 6.3	20 kHz Converter/Booster/Horn . . . . .	77
Table 6.4	30 kHz Converter . . . . .	78
Table 6.5	30 kHz Booster. . . . .	79
Table 6.6	30 kHz Converter/Booster/Horn . . . . .	80
Table 6.7	40 kHz Booster. . . . .	81
Table 6.8	40 kHz Converter/Booster/Horn . . . . .	82

## Chapter 7: Operation

Table 7.1	Setting the Amplitude Using the Front Panel Controls . . . . .	87
Table 7.2	Resetting the DCX RM B Power Supply . . . . .	89
Table 7.3	Steps to Configure the Power Supply Registers . . . . .	90
Table 7.4	Power Supply Registers . . . . .	92
Table 7.5	Power Bar-Graph Interpretation Examples . . . . .	94
Table 7.6	Frequency Bar-Graph Interpretation - 20 kHz (50 Hz Segment) . . . . .	95
Table 7.7	Frequency Bar-Graph Interpretation - 30 kHz (76 Hz Segment) . . . . .	95
Table 7.8	Frequency Bar-Graph Interpretation - 40 kHz (100 Hz/Segment) . . . . .	96
Table 7.9	Frequency Bar-Graph Interpretation Examples. . . . .	96
Table 7.10	Power Supply Ultrasonic Test Procedure (Front Panel). . . . .	102
Table 7.11	Power Supply Ultrasonic Test Procedure (User I/O). . . . .	103

## Chapter 8: Maintenance

Table 8.1	Stack Reconditioning Procedure . . . . .	109
Table 8.2	Reconditioning Stack Mating Surfaces . . . . .	110
Table 8.3	Stack Torque Values . . . . .	111
Table 8.4	Stack Reassembly for a 20 kHz System. . . . .	111
Table 8.5	Stack Reassembly for a 30 kHz System. . . . .	112
Table 8.6	Stack Reassembly for a 40 kHz System. . . . .	112
Table 8.7	Stud Torque Values. . . . .	113
Table 8.8	DCX RM B Power Supply System Cables . . . . .	115
Table 8.9	Suggested Spares. . . . .	116
Table 8.10	Converters Compatible with the DCX RM B Power Supply . . . . .	117
Table 8.11	DCX RM B Power Supply Compatible Boosters . . . . .	118
Table 8.12	Other Items used with the DCX RM B Power Supply . . . . .	120
Table 8.13	Troubleshooting . . . . .	121
Table 8.14	Troubleshooting Common Electrical Problems. . . . .	122
Table 8.15	Troubleshooting Ultrasonic Power Problems . . . . .	123
Table 8.16	Troubleshooting Weld Cycle Problems . . . . .	124

## Appendix A: Signal Diagrams

## Appendix B: Manual's Revisions

Table B.1	Manual's Revisions . . . . .	130
-----------	------------------------------	-----

---

# Chapter 1: Safety and Support

---





<b>1.1</b>	<b>Safety Requirements and Warnings</b> .....	<b>2</b>
<b>1.2</b>	<b>General Precautions</b> .....	<b>6</b>
<b>1.3</b>	<b>How to Contact Branson</b> .....	<b>9</b>




## 1.1 Safety Requirements and Warnings

This chapter contains an explanation of the different Safety Notice symbols and icons found both in this manual and on the product itself and provides additional safety information for ultrasonic welding. This chapter also describes how to contact Branson for assistance.

### 1.1.1 Symbols Found in this Manual

These symbols used throughout this manual warrant special attention:

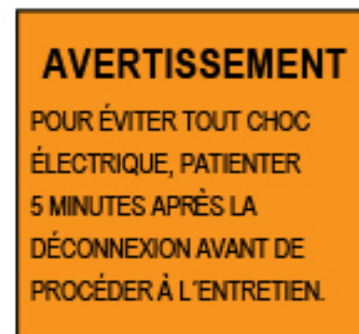
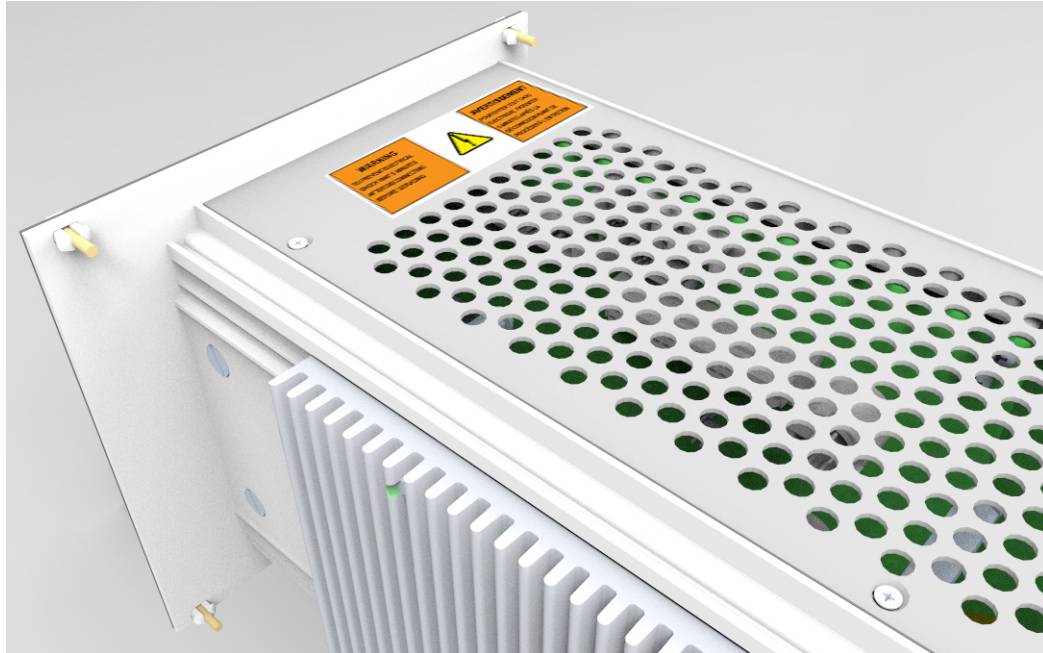
<b>WARNING</b>	<b>Indicates a possible danger</b>
	If these risks are not avoided, death or severe injury might result.
<b>WARNING</b>	<b>High Voltage Hazard</b>
	High voltage. Turn power off before servicing.
<b>WARNING</b>	<b>Corrosive Material Hazard</b>
	Corrosive material. Avoid contact with eyes and skin. Wear proper protection.
<b>CAUTION</b>	<b>Indicates a possible danger</b>
	If these risks are not avoided, slight or minor injury might result.

CAUTION	Loud Noise Hazard
	Loud noise hazard. Ear protection must be worn.
CAUTION	Heavy Object
	Heavy object. To avoid muscle strain or back injury, use lifting aids and proper lifting techniques.
NOTICE	Indicates a possible damaging situation
	<p>If this situation is not avoided, the system or something in its vicinity might get damaged.</p> <p>Application types and other important or useful information are emphasized.</p>

## 1.1.2 Symbols Found on the Product

The DCX RM B Power Supply has several safety-related labels on it to indicate the presence of hazardous voltages inside the unit.

**Figure 1.1** Safety-related Labels found on the DCX RM B Power Supply




**Figure 1.2** Safety-related Labels found on the DCX RM B Power Supply





## 1.2 General Precautions

Take the following precautions before servicing the power supply:

- To prevent the possibility of an electrical shock, always plug the power supply into a grounded power source
- To prevent the possibility of an electrical shock, ground the power supply by securing an AWG #8 grounded conductor to the ground screw located next to the air outlet
- Power supplies produce high voltage. Before working on the power supply assembly, do the following:
  - Turn off the power supply
  - Unplug main power
  - Allow at least 5 minutes for capacitors to discharge
- High voltage is present in the power supply. Do not operate with the cover removed
- High line voltages exist in the ultrasonic power supply assembly. Common points are tied to circuit reference, not chassis ground. Therefore, use only non-grounded, battery-powered multimeters when testing the power supply assembly. Using other types of test equipment can present a shock hazard
- Keep hands from under the horn. Down force (pressure) and ultrasonic vibrations can cause injury
- Do not cycle the welding system if either the RF cable or converter is disconnected
- When using larger horns, avoid situations where fingers could be pinched between the horn and the fixture
- Ensure power supply installation is performed by qualified personnel and in accordance with local standards and regulations

CAUTION	Loud Noise Hazard
	<p>Sound level and frequency of the noise emitted during the ultrasonic assembly process may depend upon <b>a.</b> type of application, <b>b.</b> size, shape and composition of the material being assembled, <b>c.</b> shape and material of the holding fixture, <b>d.</b> welder setup parameters and <b>e.</b> tool design.</p> <p>Some parts vibrate at an audible frequency during the process. Some or all of these factors may result in an uncomfortable noise being emitted during the process.</p> <p>In such cases operators may need to be provided with personal protective equipment. See 29 CFR (Code of Federal Regulations) 1910.95 Occupational Noise Exposure.</p>

NOTICE	
	<p>When the battery is worn out, dispose it under the ordinance of each local government.</p>

WARNING	Corrosive Material Hazard
	<p>First aid measures (in case of electrolyte leakage from the battery)</p> <p><b>Eye Contact:</b> Flush the eyes with plenty of clean water for at least 15 minutes immediately, without rubbing. Get immediate medical treatment. If appropriate procedures are not taken, this may cause eye injury.</p> <p><b>Skin Contact:</b> Wash the affected area under tepid running water using a mild soap. If appropriate procedures are not taken, this may cause sores on the skin. Get medical attention if irritation develops or persists.</p> <p><b>Inhalation:</b> Remove to fresh air immediately. Get medical treatment immediately.</p>

## 1.2.1 Intended Use of the System


The DCX RM B Power Supply and components are designed to be used as part of an ultrasonic welding system. These are designed for a wide variety of welding or processing applications.

If the equipment is used in a manner not specified by Branson, the protection provided by the equipment may be impaired.

Branson Ultrasonics Corp. designs and manufactures machines giving the first priority to safety precautions, to allow customers to use the machines safely and effectively. Only trained operators should run and service the equipment. Untrained operators can misuse the equipment or ignore safety instructions that can result in personal injury or equipment damage. It is most essential that all operators and service personnel pay attention to safety instructions when operating and servicing the equipment.

## 1.2.2 Emissions

Because of the various types of toxic or injurious gases that may be liberated during the welding based on the material being processed, sufficient ventilation should be provided to prevent a concentration of these gases in excess of 0.1 ppm. Check with your materials suppliers for recommended protection when processing their materials.

WARNING	Corrosive Material Hazard
	Processing of many materials, such as PVC, can be hazardous to an operator's health and could cause corrosion/damage to the equipment. Use proper ventilation and take protective measures.

## 1.2.3 Setting up the Workplace

Measures for setting up a workplace for safe operation of the ultrasonic welder are outlined in [Chapter 5: Installation and Setup](#).

## 1.2.4 Regulatory Compliance

This product meets electrical safety requirements and EMC (Electromagnetic Compliance) requirements for North America, Great Britain and the European Union.

## 1.3 How to Contact Branson

Branson is here to help you. We appreciate your business and are interested in helping you successfully use our products. To contact Branson for help, use the following telephone numbers, or contact the office nearest you.

### 1.3.1 Authorized Service Center (North America)

**Table 1.1** Authorized Service Center (North America)

Name	Address	Tel/Fax Number
Branson Ultrasonics Corp. Global Headquarters United States	120 Park Ridge Road, Brookfield, CT 06804	Tel: 1-203-796-0400 Fax: 1-203-796-0593 <a href="mailto:info@bransonultrasonics.com">info@bransonultrasonics.com</a>

### 1.3.2 Authorized Service Centers (South America)

**Table 1.2** Authorized Service Centers (South America)

Name	Address	Tel/Fax Number
Intersonic Argentina	Av. Cramer 2361 1C Buenos Aires 1428	Tel: 011-54-11-4781-2327 Fax: 011-54-11-4782-2412
Branson do Brasil Brasil	Rua Goiatuba, 81 06465-300 – Barueri / SP	Tel: 55-11-4208-1652

## 1.3.3 Authorized Service Centers (Asia)

**Table 1.3** Authorized Service Centers (Asia)

Name	Address	Tel/Fax Number
Branson Ultrasonics (Shanghai) Co. Ltd. – China Headquarters China	758 East Rong Le Road, Songjiang Songjiang Industry Zone CN-Shanghai, 201613 PRC	Tel: 86-21-3781-0588 Fax: 86-21-5774-5100 <a href="mailto:c.service@emerson.com">c.service@emerson.com</a>
Branson Ultrasonics Co. Ltd. Beijing Office	Room 216, Flat B, 12 Hong Da North Road, Chuangxin Technological Mansion Beijing Department Area. Beijing 100176 PRC	Tel: 86-10-6787-7806 Fax: 86-10-6787-3378
Branson Ultrasonics Co. Ltd. Tianjin Office		Tel: 86-22-2732-5233 Fax: 86-22-2732-3581
Branson Ultrasonics Co. Ltd. Dongguan Office		Tel: 86-769-8541-0736 Fax: 86-769-8541-0735
Branson Ultrasonics Co. Ltd. Suzhou Office		Tel: 86-512-6295-3652 Fax: 86-512-6295-3651
Branson Ultrasonics Asia Pacific Co. Ltd. Hong Kong Office	Flat A, 5/F Pioneer Building 213 Wai Yip Street, Kwung Tong Kowloon, Hong Kong	Tel: 852-2790-3393 Fax: 852-2341-2716 <a href="mailto:info@emerson.com">info@emerson.com</a>
Branson Ultrasonics Div. of Emerson Electric Co. P. Ltd. "Ajanta House" India	8/35, Marol Co-Op Industrial Estate M.V. Road, Andheri (East) Mumbai 400 059, India	Tel: 91-22-2850-5570 Fax: 91-22-2850-8681
Branson Ultrasonics Japan Headquarters Division of Emerson Japan Ltd.	4-3-14 Okada, Atsugi-Shi Kanagawa 243-0021 Japan	Tel: 81-46-228-2881 Fax: 81-46-288-8892
Branson Korea Co., Ltd. Korea	#803, 8F Dongil Techno Town 823, Kwan Yang-2dong, Dong An-gu An Yang-si, Kyung Ki-do, 431-062 Korea	Tel: 82-1577-0631 Fax: 82-31-422-9572

**Table 1.3** Authorized Service Centers (Asia)

Name	Address	Tel/Fax Number
Branson Ultrasonics Div. of Emerson Elec (M) Sdn Bhd. Malaysia	No. 20, Jalan Rajawali 3, Puchong Jaya Industrial Park Batu 8, Jalang Puchong 47170 Puchong, Selangor Malaysia	Tel: 603-8076-8608 Fax: 603-8076-8302
Branson Ultrasonics Philippines	Emerson Building 104 Laguna Blvd. Laguna Technopark Inc. Sta. Rosa, Laguna, 4026 Philippines	Tel: 63-49-502-8860 Fax: 63-49-502-8860 Mobile: 63-917-5372072
Branson Ultrasonics Singapore	10 Pandan Crescent #03-06 UE Tech Park LL3 Singapore 128466	Tel: 65-6891-7600 Fax: 65-6873-7882
Branson Ultraschall Taiwan	Div. of Emerson Electric (Taiwan) Co. Ltd. 5F-3, No. 1, Wu-Chiuan First Road Wu-Ku Ind Zone, Hsin- Chuang City Taipei Hsien 24892, Taiwan	Tel: 886-2-2298-0828 Fax: 886-2-2298-9985
Emerson Limited Thailand	662/39-40 Rama 3 Road Bangpongpan, Yannawa Bangkok 10120, Thailand	Tel: 66-2-293-01217 Fax: 66-2-293-0129

## 1.3.4 Authorized Service Centers (Europe)

**Table 1.4** Authorized Service Centers (Europe)

Name	Address	Tel/Fax Number
Branson Ultraschall Czech Republic		Tel: 420-374-625-620 Fax: 420-374-625-617
Branson Ultrasons France	1 Rue des Pyrenees Silic 404 94573 Rungis Cedex France	Tel: 33-1-4180-2550 Fax: 33-1-4687-8729
Branson Ultraschall European Headquarters Germany	Niederlassung der EMERSON Technologies GmbH & Co. OHG Waldstraße 53-55 63128 Dietzenbach, Germany	Tel: 49 (0)6074/497-0 Tel: 49 (0)6074/497-784 Fax: 49 (0)6074/497-199 <a href="mailto:info@branson.de">info@branson.de</a>
Branson Ultrasuoni, S.r.l. Italy	Via Dei Lavoratori, 25 20092 Cinisello Balsamo Milano, Italy	Tel: 39-02-660-8171 Fax: 39-02-660-10480
Branson Ultrasonics B.V. Netherlands	P.O. Box 9, 3760 Soest The Netherlands	Tel: 31-35-60-98101
Branson Ultrasonidos S.A.E. Portugal	Rua General Orlando Barbosa 74, RC-NP 4490-640 Póvoa de Varzim Portugal	Tel: 351-936-059-080 Mobil: 351-252-101-754
Emerson a.s., division Branson Slovakia	Piestandska 1202/44 91528 Nove Mesto Nad Vahom Slovak Republic	Tel: 421-32-7700-501 Fax: 421-32-7700-470
Branson Ultrasonidos S.A.E. Spain	Edificio Emerson C/Can Pi, 15 1ª Planta (Antigua Carretera del Prat) Polígono Industrial Gran Vía Sur 08908 HOSPITALET DE LLOBREGAT (BARCELONA) Spain	Tel: 34-93-586-0500 Fax: 34-93-588-2258

**Table 1.4** Authorized Service Centers (Europe)

Name	Address	Tel/Fax Number
Branson Ultrasonics S.A. Switzerland	Sonifers: Case Postale 1031 Bransonics: Chemin du Faubourg-de-Cruseilles 9 CH 1227, Carouge, Switzerland	Tel: 41-22-304-8340 Tel: 41-58-611-1222 Fax: 41-22-304-8359
Branson Ultrasonics United Kingdom	158 Edinburgh Avenue Slough, Berkshire England SL1 4UE	Tel: 44-1753-756675 Fax: 44-1753-551270
Branson Ultraschall Russia	Torfyanaya road, 7F 197374, Saint-Petersburg Russia	Tel: 7-812-449-35-24 Mobile: 7-962-693-77-12



---

## **Chapter 2: Introduction**

---

<b>2.1</b>	<b>Models Covered . . . . .</b>	<b>16</b>
<b>2.2</b>	<b>Compatibility with other Branson Products . . . . .</b>	<b>18</b>
<b>2.3</b>	<b>Features . . . . .</b>	<b>19</b>
<b>2.4</b>	<b>Controls and Indicators. . . . .</b>	<b>22</b>
<b>2.5</b>	<b>Welding Systems. . . . .</b>	<b>27</b>
<b>2.6</b>	<b>Glossary. . . . .</b>	<b>28</b>

## 2.1 Models Covered

This manual covers all models of the DCX RM B Power Supply.

**Table 2.1** Models Covered in this manual

Frequency	Power	EDP
20 kHz	1100 W	101-132-2087
	2200 W	101-132-2088
	4000 W	101-132-2089
30 kHz	1500 W	101-132-2086
40 kHz	800 W	101-132-2085

### 2.1.1 Overview of these Models

**Figure 2.1** The DCX RM B Power Supply



The DCX RM B Power Supply generates ultrasonic energy through an ultrasonic converter for welding plastics. Several models are available, depending on the desired frequency (for example, 20 kHz) and the desired power range (for example, 4.0 kW). The power supply also contains a microprocessor-based controller module that provides for control and monitoring of welding operations.

The power supply provides the following features:

**End of Weld Store:** Allows the power supply to track and store the frequency of the last weld.

**Timed Seek:** Tracks and starts the stack on the correct frequency. It does this by running the horn at a low-level amplitude (10%) to find and lock on to the stack operating frequency. Seeks are timed from the moment sonics was last activated.

**Line Regulation:** Maintains converter amplitude by regulating for variances in the line voltages.

**Load Regulation:** Maintains converter amplitude over the full range of rated power.

**System Protection:** Protects the power supply by providing five levels of protection.

- Voltage
- Current
- Phase
- Temperature
- Power
- Frequency

**Web Page Interface:** Provides access, via Ethernet connection, to power supply information, diagnostics, and configuration web pages.

**Frequency Offset:** Provides for applying an external frequency offset to the operating frequency.

**Amplitude Control:** Provides complete control of amplitude throughout the weld cycle: programmable starting ramp, and digital setting of weld amplitude.

## 2.2 Compatibility with other Branson Products

**Table 2.2** Power Supply Compatibility with Branson Converters

DCX RM B Models	Converter
20 kHz	CR-20S
	CR-20C
	CH-20S (932 AH SPL)
	CH-20C
	CS-20S
	CS-20C
	902*
30 kHz	CR-30S
	CR-30C
	CH-30S
	CH-30C
	CS-30S
	CS-30C
40 kHz	CR-40S (4TH)
	CR-40C
	4TP

\*Only for 20 kHz/1100 W power supplies.

## 2.3 Features

### 2.3.1 The Welding System

The welding system consists of a DCX RM B Power Supply and a converter-booster-horn stack. The system can perform ultrasonic welding, inserting, staking, spot welding, swaging, degating, and continuous ultrasonic operations. It is designed for automated, semi-automated and/or manual production operations.

### 2.3.2 The Power Supply

The DCX RM B Power Supply consists of an ultrasonic power supply assembly with a system controller and user interfaces. The ultrasonic power supply assembly converts conventional 50/60 Hz line current to 20 kHz, 30 kHz or 40 kHz electrical energy. The system controller controls the welding system.

Listed below are the control features of the DCX RM B Power Supply ultrasonic welding system:

**Table 2.3** Control Features

Name	Description
Autotuning	Branson power supply tuning ensures that the system is running at peak efficiency.
Digital Amplitude Setting	This feature allows you to set the exact amplitude necessary for your application, allowing increased range and setting repeatability over analog systems.
Frequency Offset	This process feature allows a user to set an offset relative to the starting frequency, for certain specific applications, where the force imparted on the fixture or anvil causes a frequency shift in the stack's operation. You should only use this feature when advised to do so by Branson.
Horn Signature	Using the DCX RM B Power Supply Web Page Interface, you may scan your ultrasonic stack to view its operating frequency on your computer, using digital readouts to give you the best picture of the stack's operation.
LCD (Liquid Crystal Display)	Provides a clear visual interface to monitor and configure the system.
Line Regulation	Maintains converter amplitude by regulating for variances in the line voltages.
Load Regulation	Maintains converter amplitude over the full range of rated power.
Membrane Keys	Front panel controls are designed for high reliability and immunity from factory dust and oils.
User ID and Passcodes	Allows for keeping track of user access to the DCX RM B Power Supply Web Page Interface.
Ramp Starting	The starting of the DCX RM B Power Supply and horn is done at a rate that helps reduce electrical and mechanical stress on the system. The horn start rate may be adjusted for some tough-to-start applications.

**Table 2.3** Control Features

Name	Description
Seek	Ensures operation at resonance; minimizes tuning errors; and operates the stack at low amplitude (10%), then provides a means of sensing and storing the resonant operating frequency value.
Start-up Diagnostics	At start-up, the controls test the major internal components.
System Protection	Protects the power supply by providing six levels of protection: voltage, current, phase, temperature, power, and frequency.
Timed Seek	When enabled, will do a Seek once every minute to update horn resonant frequency to memory. This is especially useful when the welding process affects the actual temperature of the horn, causing a resonant frequency shift.
True Watt-meter	The controls on the power supply include a true watt-meter for accurate measurement of power and energy.
Web Page Interface	Provides access, via Ethernet connection, to power supply information, diagnostics, and configuration web pages.

### **2.3.3 The Actuator**

The DCX RM B Power Supply does not provide actuator control functions, and does not interface with actuator signals.

### **2.3.4 Converter/Booster/Horn Assembly**

#### **The Converter**

The ultrasonic electrical energy from the power supply is applied to the converter (sometimes called the transducer). This transforms the high frequency electrical oscillations into mechanical vibrations at the same frequency as the electrical oscillations. The heart of the converter is piezoelectric ceramic elements. When subjected to an alternating voltage, these elements alternately expand and contract, resulting in better than 90% conversion of electrical to mechanical energy.

#### **The Booster**

Success in ultrasonic assembly depends on the right amplitude of movement at the horn face. Amplitude is a function of horn shape, which is largely determined by the size and form of the parts to be assembled. The booster can be used as a mechanical transformer to increase or decrease the amplitude of vibrations applied to the parts through the horn.

The booster is a resonant half-wave section of aluminum or titanium. It is mounted between the converter and the horn, as part of the ultrasonic stack. It also provides a clamping point for rigid stack mounting.

Boosters are designed to resonate at the same frequency as the converter with which they are used. Boosters are usually mounted at a nodal (minimum vibration) point of axial motion. This minimizes the loss of energy and prevents vibration from being transmitted to the stack supporting structure.

#### **The Horn**

The horn is selected or designed for a specific application. Each horn is tuned typically as a half-wave section that applies the necessary force and vibration uniformly to the parts to be assembled. It transfers ultrasonic vibrations from the converter to the workpiece. The horn is mounted to the booster as part of the ultrasonic stack.

Depending on their profile, horns are referred to as stepped, conical, exponential, bar, or catenoidal. The shape of the horn determines the amplitude at the face of the horn. Depending on the application, horns can be made from titanium alloys, aluminum, or steel. Titanium alloys are the best materials for horn fabrication due to their high level of strength and low loss. Aluminum horns are usually chrome- or nickel-plated or hard-coated to reduce wear. Steel horns are for low amplitude requiring hardness, such as ultrasonic insertion applications.

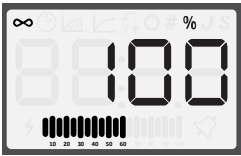


## 2.4 Controls and Indicators

### 2.4.1 DCX RM B Power Supply Front Panel

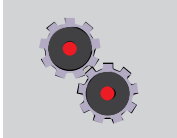
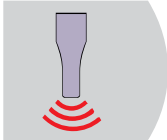
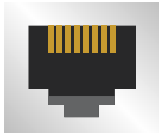


**Figure 2.2** DCX RM B Power Supply Front Panel Controls and Indicators



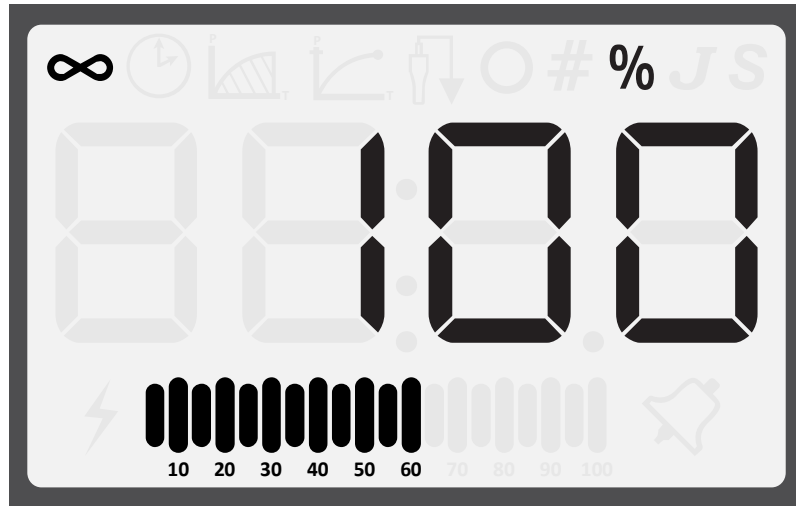
**Table 2.4** DCX RM B Power Supply Front Panel Controls and Indicators

Reference	Description
	<p><b>LCD</b></p> <p>For detailed information refer to <a href="#">Figure 2.3 LCD Description</a> and <a href="#">Table 2.5 LCD Description</a>.</p>
	<p><b>Up/Down Keys</b></p> <p>Use to adjust the amplitude of ultrasonic vibrations (10% to 100%). Also used to adjust weld mode parameters, select registers and edit register values.</p>
	<p><b>Alarm Reset Key</b></p> <p>Use the Reset key to reset alarms.</p> <p>When changing system registers, use the Reset key to set a register back to its default value after entering the register and before editing the value.</p>



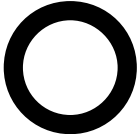


**Table 2.4** DCX RM B Power Supply Front Panel Controls and Indicators

Reference	Description
	<p><b>Configuration Key</b></p> <p>Use the Configuration key to change system registers. Registers are used to change system parameters. For information on using the Configuration key to set system registers see <a href="#">7.4 Configuring the Power Supply Registers</a>.</p>
	<p><b>Ultrasonics Test Key</b></p> <p>Use the Test key to perform an ultrasonic test. Test performs a seek and then ramps the amplitude to the current setting.</p>
	<p><b>Ethernet Port</b></p> <p>Use the Ethernet Port to connect to the DCX RM B Power Supply Web Page Interface.</p>
	<p><b>Power-On Indicator</b></p> <p>Lights when the power supply is connected to main power.</p>
	<p><b>24 V Indicator</b></p> <p>Lights when 24 V DC are supplied to the DCX RM B Power Supply.</p>




**Figure 2.3** LCD Description



**Table 2.5** LCD Description

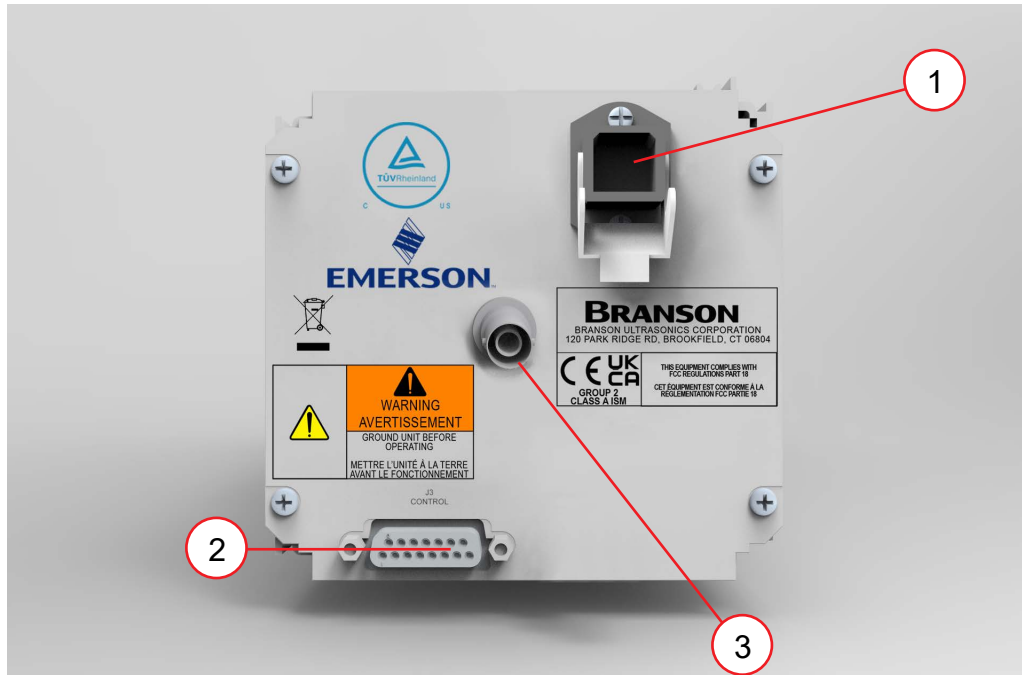
Reference	Description
	<p><b>Numeric Display</b></p> <p>Displays the Power Supply amplitude settings, register numbers, register values or alarm numbers.</p>
	<p><b>Continuous Mode Icon</b></p> <p>Indicates the power supply is running in Continuous mode. When in Continuous mode, the amplitude setting is shown on the numeric display in conjunction with the % icon. The amplitude setting may range from 10% to 100%. For more information see <a href="#">Chapter 7: Operation</a>.</p>
	<p><b>Circle Icon</b></p> <p>Indicates that the value shown on the numeric display is a register value. Use up and down keys to modify the register value. For more information see <a href="#">7.4 Configuring the Power Supply Registers</a>.</p>
	<p><b>Number Sign Icon</b></p> <p>Indicates that the value shown on the numeric display is a register number. Use up and down keys to select a register. For more information see <a href="#">7.4 Configuring the Power Supply Registers</a>.</p>
	<p><b>Percentage Icon</b></p> <p>Indicates that the value shown on the numeric display represents a percentage. When in Peak Power mode, the value shown on the numeric display represents a percentage of the power supply rated power. If not in Peak Power mode, the value shown on the numeric represents the amplitude setting.</p>

**Table 2.5** LCD Description

Reference	Description
	<p><b>Sonics Active Indicator</b> Indicates ultrasonics is running.</p>
	<p><b>Power/Frequency Bar-Graph</b> Shows the true percentage of ultrasonic power during a weld cycle. The bar-graph can be configured to show the peak power or the memory frequency at the end of each weld or test cycle. For instructions on how to modify this setting see <a href="#">7.4 Configuring the Power Supply Registers</a>. For detailed bar-graph description and bar-graph reading examples, see <a href="#">7.5.1 Power Bar-Graph Interpretation</a> and <a href="#">7.5.2 Frequency Bar-Graph Interpretation</a>.</p>
	<p><b>Alarm Icon</b> A flashing icon which indicates and alarm condition.</p>

## 2.4.2 DCX RM B Power Supply Connections

**Figure 2.4** DCX RM B Power Supply Back Panel



**Table 2.6** Connections to the DCX RM B Power Supply

Item	Name	Function
1	Line Input Connector	Power connector for connecting the line voltage. For wiring details refer to <a href="#">Chapter 5: Installation and Setup</a> .
2	User I/O Connector	Provides the necessary input/output signals to interface with user automation or control interfaces. For detailed information on interfacing with the DCX RM B Power Supply refer to <a href="#">Chapter 5: Installation and Setup</a> .
3	RF Connector	SHV connector for RF cable, which provides ultrasonic energy to the converter.

## **2.5 Welding Systems**

### **2.5.1 Principle of Operation**

Thermoplastic parts are welded ultrasonically by applying high frequency vibrations to the parts being assembled. The vibrations, through surface and intermolecular friction, produce a sharp rise in temperature at the welding interface.

When the temperature is high enough to melt the plastic, there is a flow of material between the parts. When the vibrations stop, the material solidifies under pressure and a weld results.

### **2.5.2 Weld System Applications**

DCX RM B Power Supply weld systems can be used for the following applications:

- Ultrasonic welding
- Cutting and sealing thermoplastic fabric and film
- Staking, spot welding, swaging, and degating thermoplastic parts
- Other ultrasonic processing applications

DCX RM B Power Supply weld systems typically consist of a power supply operated with a fixed converter-booster-horn stack.

## 2.6 Glossary

The following terminology may be encountered when using or operating a DCX RM B Power Supply ultrasonic welding system:

**Table 2.7** Glossary

Name	Description
Actuator	The unit which houses the converter/booster/horn stack assembly in a rigid mounting, allowing the stack to move up and down, either mechanically or pneumatically, applying force to the part at a user-adjustable force and velocity.
Alarm	Visual indication of error.
Amplitude Control	The ability to set amplitude digitally or by an external control.
Amplitude	The peak-to-peak movement at the horn face. Always expressed as a percentage of the maximum.
Booster	A one-half-wavelength-long resonant metal section mounted between the converter and horn, sometimes having a change in cross-sectional area between the input and output surfaces. The booster mechanically alters the amplitude of vibrations received from the converter, and imparts the new amplitude to the horn.
Clamping Force	The pounds or kilograms exerted by the horn onto the workpiece.
Cold Start	Restores the settings of the power supply back to its original condition.
Converter	The device that converts electrical energy into mechanical vibrations at a high frequency (an ultrasonic rate).
Counters	A record of the number of preset cycles recorded in the power supply.
Degating	Removing a molded part from its runner system.
Energy Director	A triangular-shaped projection of plastic material which concentrates the ultrasonic energy at the joint interface of a plastic part.
External Amplitude Control	Enables you to access real-time amplitude control directly via the user I/O connector.
External Frequency Control	Enables you to access real-time frequency offset control directly via the user I/O connector.
Fixture	A device for holding a part in position for assembly.
Flash	Material displaced from the joint area.
Forming	Reshaping a section of thermoplastic.
Fretting Corrosion	A black surface condition, that results from friction between metal parts, that appears on the converter-booster-horn stack mating surfaces.
Frequency	The operating frequency of the ultrasonic stack. The frequency stored is measured at the end of the ultrasonic portion of the cycle (when ultrasonics are terminated).

**Table 2.7** Glossary

Name	Description
Frequency Offset	An offset factor applied to the ultrasonic frequency stored in the power supply.
Gain	The ratio of output to input amplitude of a horn or booster.
Horn	A bar or metal section, usually one half-wavelength-long which transfers vibratory energy to the workpiece.
Horn Amplitude	The peak-to-peak displacement of a horn at its work face.
Horn Signature	A scan to enhance selection of operating frequency and control parameters.
Insertion	The process of embedding a metal component in plastic.
Interface	<ol style="list-style-type: none"> <li>1. The contact surface of two mating parts.</li> <li>2. The connection between two pieces of equipment.</li> </ol>
Joint	The weld surfaces.
Parameter	A unique factor or element which affects the welding operation in a particular mode.
Parameter Range	Valid range of parameters accepted for a particular setup.
Power Supply	The electronic instrument in an ultrasonic assembly system which changes conventional 50/60 Hz electrical power into high frequency electrical power at 20 kHz, 30 kHz or 40 kHz.
Seek	The activation of ultrasonics at a low-level (10%) amplitude, for the purpose of finding the resonant frequency of the stack.
Staking	The process of melting and reforming a plastic stud to mechanically lock a dissimilar material in place.
Swaging	The process of capturing another component of an assembly by melting and reforming a ridge of plastic.
Thermoplastic	A polymer which undergoes a reversible change of state when subjected to heat.
Thermoset	A polymer which undergoes an irreversible change when subjected to heat.
Ultrasonic Power	Presence of ultrasonic power at the horn face.
Ultrasonic Welding	The use of ultrasonic vibrations to generate heat and subsequently melt the mating surfaces of two thermoplastic parts. When ultrasonic vibrations stop, the molten material resolidifies, and a weld occurs.
User ID	A unique 12 character long alphanumeric ID used to keep track of user access to the web page interface.
Weld System	A combination of components required to perform an ultrasonic operation. Usually consists of a power supply, converter, booster, and horn, with either an actuator or a handheld device, or in a fixed, mounted location.




---

## **Chapter 3: Delivery and Handling**

---

<b>3.1</b>	<b>Shipping and Handling</b> .....	<b>32</b>
<b>3.2</b>	<b>Receiving</b> .....	<b>33</b>
<b>3.3</b>	<b>Unpacking the Power Supply</b> .....	<b>34</b>
<b>3.4</b>	<b>Take Inventory of Small Parts</b> .....	<b>35</b>
<b>3.5</b>	<b>Returning Equipment</b> .....	<b>36</b>

## 3.1 Shipping and Handling

CAUTION	Heavy Object
	<p>The power supply may be heavy. Handling, unpacking, and installation may require the assistance of a colleague or the use of lifting platforms or hoists.</p>

### 3.1.1 Environmental Specifications

The DCX RM B Power Supply is an electronic unit that converts line voltage to ultrasonic energy and responds to user input for regulating the weld process. Its internal components are sensitive to static discharge, and many of its components can be harmed if the unit is dropped, shipped under improper conditions, or otherwise mishandled.

The following environmental guidelines should be respected in the shipping of the power supply.

**Table 3.1** Shipping Specifications

Environmental Condition	Acceptable Range
Storage / Shipping Temperature	-25° C / -13° F to +55° C / +131° F (+70° C / +158° F for 24 hours)
Shock / Vibration (transit)	45 g shock / 0.5 g and (3 to 100 Hz) vibration per ASTM 3332-88 and 3580-90
Drop Test	ISTA Procedure 1 & 2A (while packaged)
Humidity	Maximum 95%, non-condensing

## 3.2 Receiving

The DCX RM B Power Supply is a sensitive electronic device. Many of its components can be harmed if the unit is dropped or otherwise mishandled.


### Scope of Delivery

Branson equipment is carefully checked and packed before dispatch. It is recommended, however, that you follow the procedure below upon receiving your DCX RM B Power Supply.


### Inspect the Power Supply when it is delivered, take the following steps:

**Table 3.2** Inspect the power supply

Step	Action
1	Verify that all parts are complete according to the packing slip.
2	Check the packing and the unit for damage (visual inspection).
3	Report any damage claims to your carrier immediately.
4	Determine if any component has become loose during shipping and, if necessary, tighten screws.

NOTICE	
	<p>If the goods delivered have been damaged during shipping, please contact the forwarding agent immediately. Retain packing material (for possible inspection or for sending back the unit).</p>

## 3.3 Unpacking the Power Supply

NOTICE	
	<p>If there are any visible signs of damage to the shipping containers or the product, or you later discover hidden damage, NOTIFY YOUR CARRIER IMMEDIATELY. Save the packing material.</p>

The power supply is fully assembled. It is shipped in a sturdy cardboard box. Some additional items are shipped in the box with the power supply. Note orientation of packaging material in case return/repack is necessary. When unpacking the power supply, take the following steps:

**Table 3.3** Unpacking the power supply

Step	Action
1	Unpack the power supply as soon as it arrives. Save the packing material
2	Verify you have all of the equipment ordered. Some components are packed inside other boxes.
3	Inspect the controls, indicators, and surface for signs of damage.
4	Remove the cover of the power supply to check if any components became loose during shipping.

## 3.4 Take Inventory of Small Parts

**Table 3.4** Small Parts included (=x) Power Supply Assemblies

Part or Kit	20 kHz	30 kHz	40 kHz
Mylar <sup>®</sup> plastic film Washer Kit	X	X	
Silicone Grease			X
Spanners (2)	X	X	X

\* Mylar is a registered trademark of DuPont Teijin Films.

### 3.4.1 Cables

The RF cable connects the power supply to the converter. For automated systems you will also need a user I/O cable to monitor and control the power supply. Check your invoice for cable types and cable lengths.

**Table 3.5** DCX RM B Power Supply System Cables

P/N	Description
100-240-383	Cable, RF 8 ft (2.5 m)
100-240-384	Cable, RF 15 ft (4.5 m)
100-240-385	Cable, RF 25 ft (7.5 m)
100-240-387	Cable, RF right angle 8 ft (2.5 m)
100-240-388	Cable, RF right angle 15 ft (4.5 m)
100-240-389	Cable, RF right angle 25 ft (7.5 m)
011-003-515	Cable, JDC 3 control
200-240-396	Cable Ethernet Cat 5e 7 ft (2.1 m)

## 3.5 Returning Equipment

If you are returning equipment to Branson Ultrasonic Corporation, please call your Customer Service Representative to receive approval to return the goods. Refer to [1.3 How to Contact Branson](#).


---

## **Chapter 4: Technical Specifications**

---

<b>4.1</b>	<b>Technical Specifications</b> .....	<b>38</b>
<b>4.2</b>	<b>Physical Description</b> .....	<b>40</b>
<b>4.3</b>	<b>EU Declaration of Conformity</b> .....	<b>41</b>
<b>4.4</b>	<b>UK Declaration of Conformity</b> .....	<b>42</b>

## 4.1 Technical Specifications

NOTICE	
	All specifications are subject to change without notice.

### 4.1.1 Environmental Specifications

The DCX RM B Power Supply has the following environmental specifications:

**Table 4.1** Environmental Specifications

Environmental Condition	Acceptable Range
Ambient Operating Temperature	+41° F to +104° F (+5° C to +40° C)
Storage / Shipping Temperature	-13° F to +131° F (-25° C to +55° C)
Operating Altitude	Up to 6560 ft (2000 m)
Humidity	Maximum 95%, non-condensing
IP Rating	20 Protected against solid objects larger than 12.5 mm; no protection against water.
Pollution degree	2 Only non-conductive pollution occurs; temporary conductivity caused by condensation may be expected.
Overvoltage category	II Equipment intended to be supplied from the building wiring.

### 4.1.2 Electrical Specifications

The following tables list input voltage and current requirements for the DCX RM B Power Supply.

**Table 4.2** Electrical Input Operating Voltages

Power Supply Rating	Input Operating Voltage
All Models	200 V to 230 V Nominal (180 V Min.* to 253 V Max.), 50 Hz or 60 Hz, Single Phase
	24 VDC, 2.5 A.

\* 200 V Min. for 4 kW units.

**Table 4.3** Input Current and Fuse Specifications

Model	Power	Current Rating
20 kHz	1100 W	10 A Max. @ 200 V / 15 A Fuse
	2200 W	14 A Max. @ 200 V / 15 A Fuse
	4000 W	25 A Max. @ 200 V / 25 A Fuse
30 kHz	1500 W	10 A Max. @ 200 V / 15 A Fuse
40 kHz	800 W	5 A Max. @ 200 V / 15 A Fuse

**Table 4.4** Continuous Duty Max. Power

Model	Power	Continuous Duty. Max. Power
20 kHz	1100 W	330 W
	2200 W	660 W
	4000 W	1200 W
30 kHz	1500 W	460 W
40 kHz	800 W	240 W

**NOTICE**


High duty cycles require additional cooling for the converter. For information on converter cooling refer to [5.6 Converter Cooling](#) in [Chapter 5: Installation and Setup](#).

**NOTICE**

System average power must be limited to the specified continuous maximum. Higher peak power, up to the maximum acceptable power limit, with an on time of up to 10 seconds may be obtained if appropriate off time ensures that, on average, the Continuous Duty Maximum Power is not exceeded.

## 4.2 Physical Description

This section describes the physical dimensions of the DCX RM B Power Supply.

NOTICE	
	Dimensions are nominal.

**Table 4.5** Dimensions and Weights of DCX RM B Power Supply

Size	Width	Height	Depth	Weight
Small	4.2" 106 mm	5.07" 128 mm	22" 560 mm	8 lb 3.6 kg
Medium	5.6" 142 mm			12 lb 5.4 kg
Large	8.4" 213 mm			15 lb 6.8 kg

For detailed dimensional information refer to [Chapter 5: Installation and Setup](#).

## 4.3 EU Declaration of Conformity

Figure 4.1 Declaration of Conformity

**EU DECLARATION OF CONFORMITY**

CE

We, the manufacturer

**BRANSON ULTRASONICS CORPORATION**  
120 Park Ridge Rd.  
Brookfield, CT 06804  
USA

represented in the community by

BRANSON ULTRASONICS, a.s.  
Piestanska 1202  
91501 Nove Mesto nad Vahom  
Slovak Republic

expressly declare under our sole responsibility that the following electrical equipment product:

Ultrasonic Assembly System consisting of an Ultrasonic Power Supply, model:

0.80 DCX(S, A, f-EIP, f-DP or f-pfn) 40 RACKMT 1.50 DCX(S, A, f-EIP, f-DP or f-pfn) 30 RACKMT 1.25 DCX(S, A, f-EIP, f-DP or f-pfn) 20 RACKMT 2.50 DCX(S, A, f-EIP, f-DP or f-pfn) 20 RACKMT 4.00 DCX(S, A, f-EIP, f-DP or f-pfn) 20 RACKMT DCX RM 222 STD DCX RM 240 STD DCX RM 222 B DCX RM 240 B DCX RM 480 STD DCX RM 315 STD DCX RM 211 STD DCX RM 480 B DCX RM 315 B DCX RM 211 B P/S 2.20 DCX STD 20 SIG	0.40DCX(s, v, a, f-dp, f-eip or f-pfn)40(VRT, V, H or HOR) 0.80DCX(s, v, a, f-dp, f-eip or f-pfn)40(VRT, V, H or HOR) 0.75DCX(s, v, a, f-dp, f-eip or f-pfn)30(VRT, V, H or HOR) 1.50DCX(s, v, a, f-dp, f-eip or f-pfn)30(VRT, V, H or HOR) 1.25DCX(s, v, a, f-dp, f-eip or f-pfn)20(VRT, V, H or HOR) 2.50DCX(S+, s, v, a, f-dp, f-eip or f-pfn)20(VRT, V, H or HOR) 4.00DCX(S+, s, v, a, f-dp, f-eip or f-pfn)20(VRT, V, H or HOR) 4.00DCXs20HD -V P/S 0.8 DCX S HD 40 VRT 1.50 DCX-S HD 30 (HOR or VRT) 1.50 DCX-S HD 30 VRT 4.00DCXs20HD -H P/S 0.8 DCX S HD 40 HOR P/S 4.0KW 20KHZ DCX S LIM RES 1.6DCX(a, f-dp, f-eip or f-pfn)40(B2H or B2V)
---	---

used with converter model: CR-20S, CR-20C, CH-20C, CS-20S, CS-20C, CR-30, CR-30C, CH-30, CH-30C, CS-30S, CS-30C, CR-40C, 4TH, 4TP or 932, and associated cables.

in the state in which it was placed on the market, fulfills all the relevant provisions and their amendments of:

Low Voltage Directive **2014/35/EU**  
EMC Directive **2014/30/EU**  
RoHS Directive **2011/65/EU**

The object of this declaration is in conformity with relevant Union harmonization legislation. The electrical equipment product, to which this declaration relates, is in conformity with the following standards:

EN 61010-1:2010+A1:2019  
EN 55011:2016/A11:2020  
EN 61000-6-2:2005/AC:2005

Brookfield, CT, USA

*Luis Benavides*

Luis Benavides (Feb 17, 2026 14:02:32 CST)

Director of Engineering, Systems / Product Safety Officer

## 4.4 UK Declaration of Conformity

Figure 4.2 UK Declaration of Conformity



### UK DECLARATION OF CONFORMITY

We, the manufacturer

**BRANSON ULTRASONICS CORPORATION**  
120 Park Ridge Rd.  
Brookfield, CT 06804  
USA

expressly declare under our sole responsibility that the following electrical equipment product:

Ultrasonic Assembly System consisting of an Ultrasonic Power Supply, model:

0.80 DCX(S, A, f-EIP, f-DP or f-pfn) 40 RACKMT	0.40DCX(s, v, a, f-dp, f-eip or f-pfn)40(VRT, V, H or HOR)
1.50 DCX(S, A, f-EIP, f-DP or f-pfn) 30 RACKMT	0.80DCX(s, v, a, f-dp, f-eip or f-pfn)40(VRT, V, H or HOR)
1.25 DCX(S, A, f-EIP, f-DP or f-pfn) 20 RACKMT	0.75DCX(s, v, a, f-dp, f-eip or f-pfn)30(VRT, V, H or HOR)
2.50 DCX(S, A, f-EIP, f-DP or f-pfn) 20 RACKMT	1.50DCX(s, v, a, f-dp, f-eip or f-pfn)30(VRT, V, H or HOR)
4.00 DCX(S, A, f-EIP, f-DP or f-pfn) 20 RACKMT	1.25DCX(s, v, a, f-dp, f-eip or f-pfn)20(VRT, V, H or HOR)
DCX RM 222 STD	2.50DCX(S+, s, v, a, f-dp, f-eip or f-pfn)20(VRT, V, H or HOR)
DCX RM 240 STD	4.00DCX(S+, s, v, a, f-dp, f-eip or f-pfn)20(VRT, V, H or HOR)
DCX RM 222 B	4.00DCXs20HD -V
DCX RM 240 B	P/S 0.8 DCX S HD 40 VRT
DCX RM 480 STD	1.50 DCX-S HD 30 (HOR or VRT)
DCX RM 315 STD	1.50 DCX-S HD 30 VRT
DCX RM 211 STD	4.00DCXs20HD -H
DCX RM 480 B	P/S 0.8 DCX S HD 40 HOR
DCX RM 315 B	P/S 4.0K W 20KHZ DCX S LIM RES
DCX RM 211 B	1.6DCX(a, f-dp, f-eip or f-pfn)40(B2H or B2V)
P/S 2.20 DCX STD 20 SIG	

used with converter model: CR-20S, CR-20C, CH-20C, CS-20S, CS-20C, CR-30, CR-30C, CH-30, CH-30C, CS-30S, CS-30C, CR-40C, 4TH, 4TP or 932, and associated cables.

in the state in which it was placed on the market, fulfills all the relevant provisions and their amendments of:

Electrical Equipment (Safety) Regulations **2016**  
Electromagnetic Compatibility Regulations **2016**  
Restriction of the Use of Certain Hazardous Substances in Electrical and Electronic Equipment Regulations **2012**.

The electrical equipment product, to which this declaration relates, is in conformity with the following designated standards:

EN 61010-1:2010+A1:2019  
EN 55011:2016/A11:2020  
EN 61000-6-2:2005/AC:2005

Brookfield, CT, USA

*Luis Benavides*

[Luis Benavides \(Feb 17, 2026 14:02:48 CST\)](#)

Director of Engineering, Systems / Product Safety Officer

---


## **Chapter 5: Installation and Setup**

---

<b>5.1</b>	<b>About Installation . . . . .</b>	<b>44</b>
<b>5.2</b>	<b>Installation Requirements. . . . .</b>	<b>45</b>
<b>5.3</b>	<b>Installation Steps . . . . .</b>	<b>50</b>
<b>5.4</b>	<b>Power Supply Configuration . . . . .</b>	<b>63</b>
<b>5.5</b>	<b>Assembling the Acoustic Stack . . . . .</b>	<b>64</b>
<b>5.6</b>	<b>Converter Cooling . . . . .</b>	<b>69</b>
<b>5.7</b>	<b>Testing the Installation. . . . .</b>	<b>71</b>
<b>5.8</b>	<b>Still Need Help? . . . . .</b>	<b>72</b>

## 5.1 About Installation

This chapter is intended to help the installer with the basic installation and setup of your new DCX RM B Power Supply.

<b>CAUTION</b>	<b>Heavy Object</b>
	The power supply, and related components are heavy. Handling, unpacking, and installation may require the assistance of a colleague or the use of lifting platforms or hoists.

International safety-related labels are found on the power supply. Those that are of importance during installation of the system are identified in [Figure 1.1 Safety-related Labels found on the DCX RM B Power Supply](#) and [Figure 1.2 Safety-related Labels found on the DCX RM B Power Supply](#).

## 5.2 Installation Requirements

This section covers the location requirements, mounting options, power supply dimensions, environmental requirements, and electrical requirements, to help you plan and execute your installation successfully.

### 5.2.1 Installing the DCX RM B Power Supply Drawers in a Customer Rack

The power supply units can be installed in any rack complying with the 19" industrial standard.

For successful installation in a rack, the respective demands on the electric and cooling system have to be met.

- If multiple drawers are to be installed in a rack we recommend to provide three phase power to the rack in order to provide each drawer with a dedicated supply and one phase to each drawer
- Particular care has to be taken that the heat generated during operation is dissipated. The heat generated depends on the power output by the module and the ambient conditions
- The heat sink of the module is mounted on the right. Make sure that the cooling device is mounted in a way allowing the cooling air to pass freely on this side
- For each group of four power supply modules installed one cooling drawer is required. The cooling drawers must be installed directly under the power supplies in order to ensure sufficient cooling
- In case a filter element is used to clean the intake air, regular inspection and cleaning of the filter depending on the ambient conditions is required to maintain the airflow volume
- To prevent thermal overload, the system is protected by thermostats which are reset automatically after cooling down

### 5.2.2 Location

The power supply should be accessible for parameter changes and settings. The power supply should be located in an area away from radiators or heating vents.

The DCX RM B Power Supply must not be positioned so that is difficult to plug in or unplug the main power plug.

### 5.2.3 Dimensions

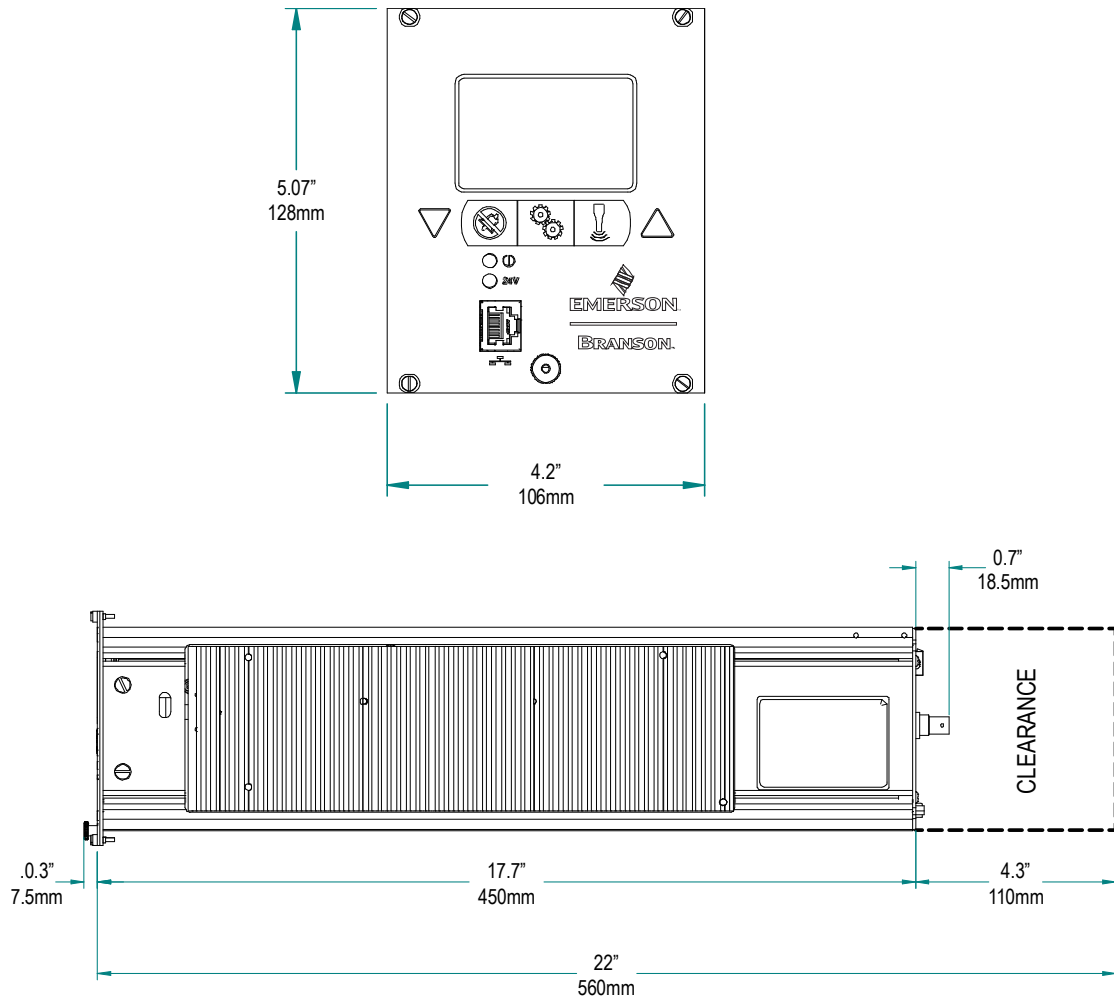
Refer to the illustrations on the pages that follow for dimensional drawings. All dimensions are approximate and may vary slightly:

[Figure 5.1 DCX RM B Power Supply Dimensional Drawing \(Small\)](#)

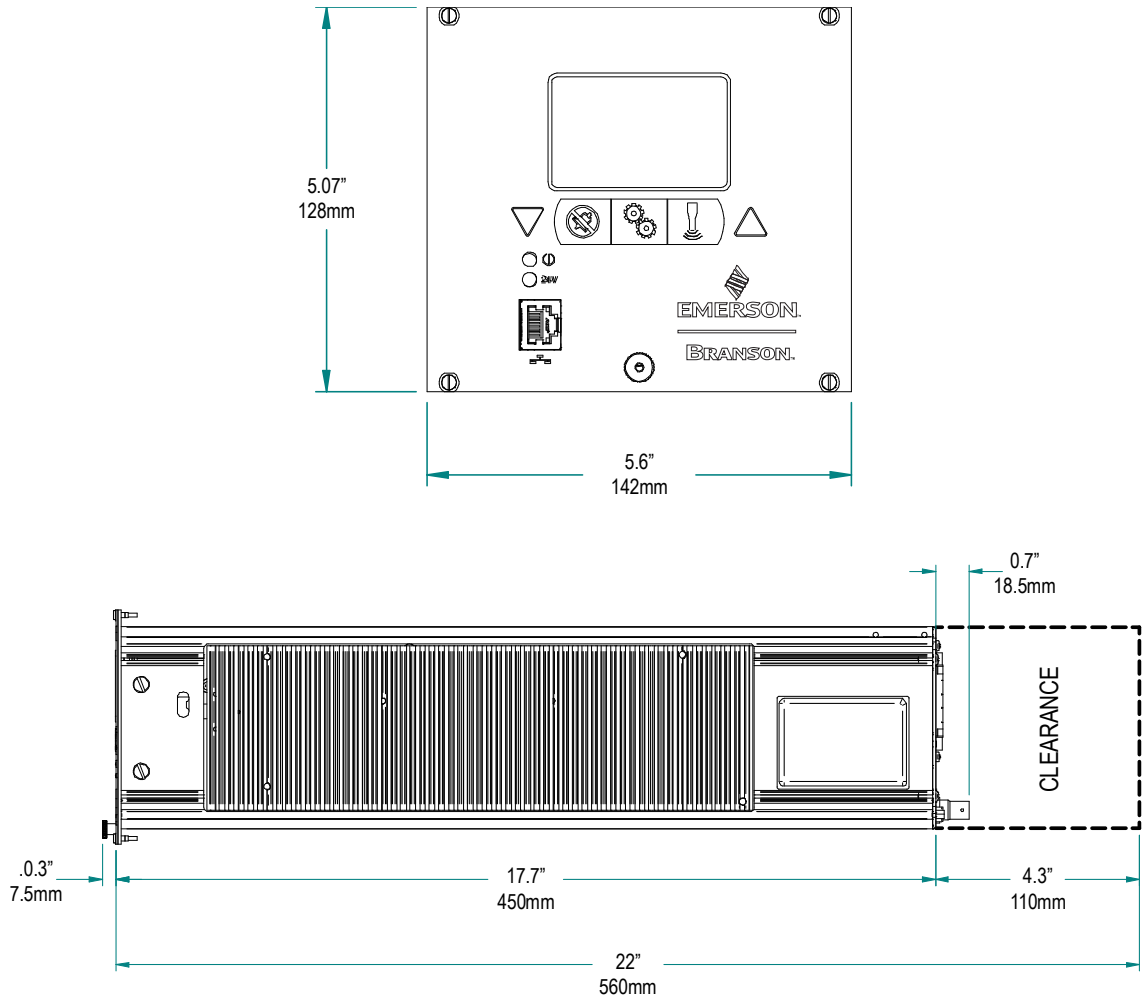
[Figure 5.2 DCX RM B Power Supply Dimensional Drawing \(Medium\)](#)

[Figure 5.3 DCX RM B Power Supply Dimensional Drawing \(Large\)](#)

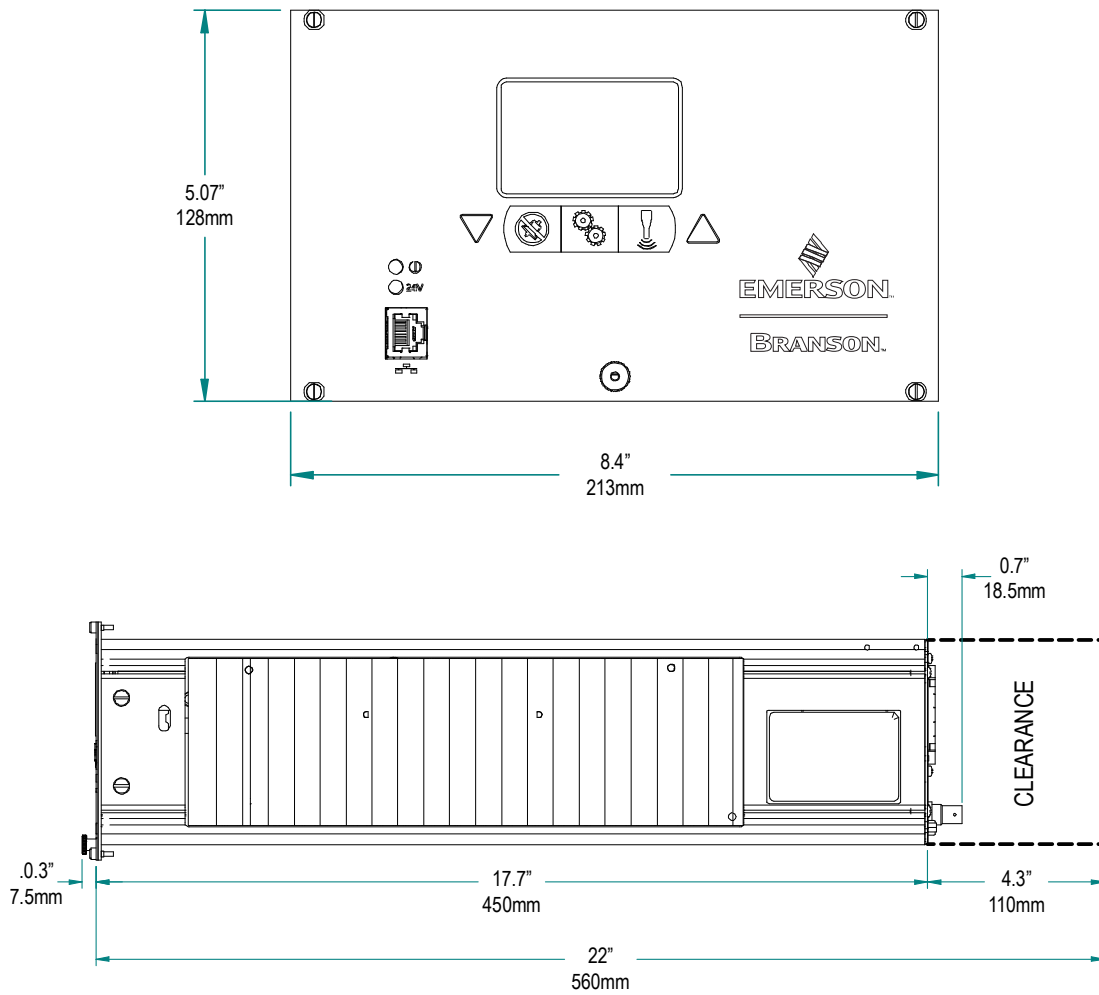
**Figure 5.1** DCX RM B Power Supply Dimensional Drawing (Small)



**Figure 5.2** DCX RM B Power Supply Dimensional Drawing (Medium)



**Figure 5.3** DCX RM B Power Supply Dimensional Drawing (Large)



## 5.2.4 Environmental Requirements

Verify the DCX RM B Power Supply is operated in an environment that meets the temperature and humidity requirements indicated in [Table 5.1 Environmental Requirements](#).

**Table 5.1** Environmental Requirements

Environmental Condition	Acceptable Range
Ambient Operating Temperature	+41° F to +104° F (+5° C to +40° C)
Operating Altitude	Up to 6560 ft (2000 m)
Humidity	Maximum 95%, non-condensing
IP Rating	20 Protected against solid objects larger than 12.5 mm; no protection against water.
Pollution degree	2 Only non-conductive pollution occurs; temporary conductivity caused by condensation may be expected.
Overtoltage category	II Equipment intended to be supplied from the building wiring.

## 5.2.5 Electrical Input Power Ratings

Connect the power supply to a single-phase, grounded, 3-wire, 50 Hz or 60 Hz 200 V to 230 V power source. [Table 5.2 Input Current and Circuit Breaker Specifications](#) lists the current and breaker ratings for the various models.

**Table 5.2** Input Current and Circuit Breaker Specifications

Model	Power	Current Rating
20 kHz	1100 W	10 A Max. @ 200 V / 15 A Breaker
	2200 W	14 A Max. @ 200 V / 15 A Breaker
	4000 W	25 A Max. @ 200 V / 25 A Breaker
30 kHz	1500 W	10 A Max. @ 200 V / 15 A Breaker
40 kHz	800 W	5 A Max. @ 200 V / 10 A Breaker


## 5.2.6 Pneumatic Requirements

Your welding system may require a cooling air stream for the converters. In continuous operations, or applications with longer duty cycles, it may be necessary to cool the horn as well as the converter.

Typically 80 cubic feet (2.26 m<sup>3</sup>) per hour of clean, dry, compressed air are required to cool most welding operations.

To verify the 80 cubic feet (2.26 m<sup>3</sup>) per hour cooling air stream required for your welding system, refer to [5.6 Converter Cooling](#).

## 5.3 Installation Steps

WARNING	High Voltage Hazard
	<p>To prevent the possibility of an electrical shock:</p> <ul style="list-style-type: none"><li>• Ensure the power source is disconnected before beginning to work on line connections</li><li>• Ensure the power switch on the back of the unit is in the OFF position before making any electrical connections</li><li>• Always plug the power supply into a grounded power source</li><li>• To prevent the possibility of an electrical shock, ground the power supply by securing an AWG #14 grounded conductor to the ground screw located next to the air outlet</li><li>• Ensure power supply installation is performed by qualified personnel and in accordance with local standards and regulations</li></ul>


### Basic installation notes:

- To avoid problems associated with EMI, you should route high power lines (AC and Ultrasonic RF) away from low power lines (controls signals)
- You should consider future troubleshooting and repair when installing all wiring. All wiring should be either color coded or tagged with industrial wire tags
- The minimum cable bend radius is 5 times the cable outer diameter for RF cables
- The minimum cable bend radius is 10 times the cable outer diameter for user I/O & Ethernet cables
- Ground wires should not be shared with other equipment
- All inductive coils must be suppressed with appropriate devices, such as diodes or RC networks

## 5.3.1 Mount the Power Supply

The cable lengths are limited based on the operating frequency of the welding system. Performance and results can suffer if the RF cable is crushed, pinched, damaged or modified. Contact your Branson Representative if you have special cable requirements.

Do not place the power supply on the floor or in other locations that will allow dust, dirt or contaminants to be drawn into the power supply.

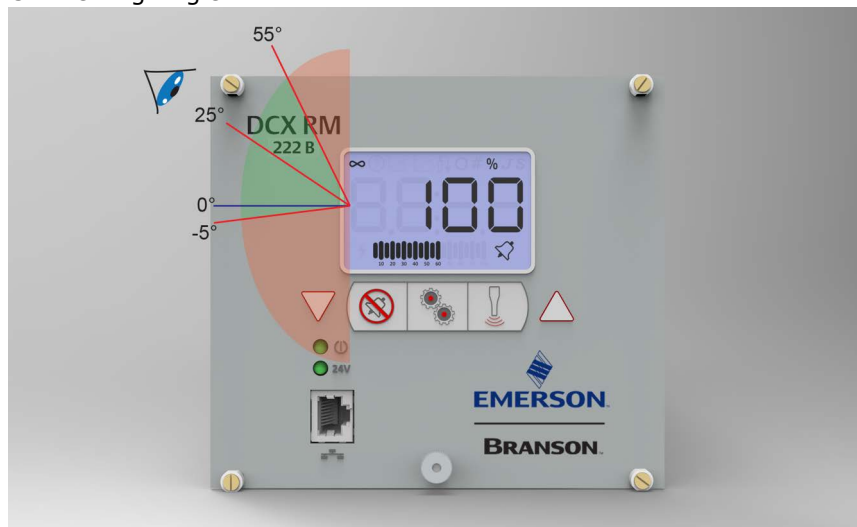
NOTICE	
	<p>Do not block exhaust and intake air circulation, which is needed to maintain a safe operating temperature.</p>


For dimensional drawings of the DCX RM B Power Supply, see figures [Figure 5.1 DCX RM B Power Supply Dimensional Drawing \(Small\)](#), [Figure 5.2 DCX RM B Power Supply Dimensional Drawing \(Medium\)](#), and [Figure 5.3 DCX RM B Power Supply Dimensional Drawing \(Large\)](#).

## 5.3.2 Mounting Considerations

In addition to the considerations mentioned above, the LCD's viewing angle should be taken into account when selecting a location for your DCX RM B Power Supply. The LCD is designed to be viewed from the top. Please refer to [Figure 5.4 LCD Viewing Angle](#) below when selecting a location for your DCX RM B Power Supply.

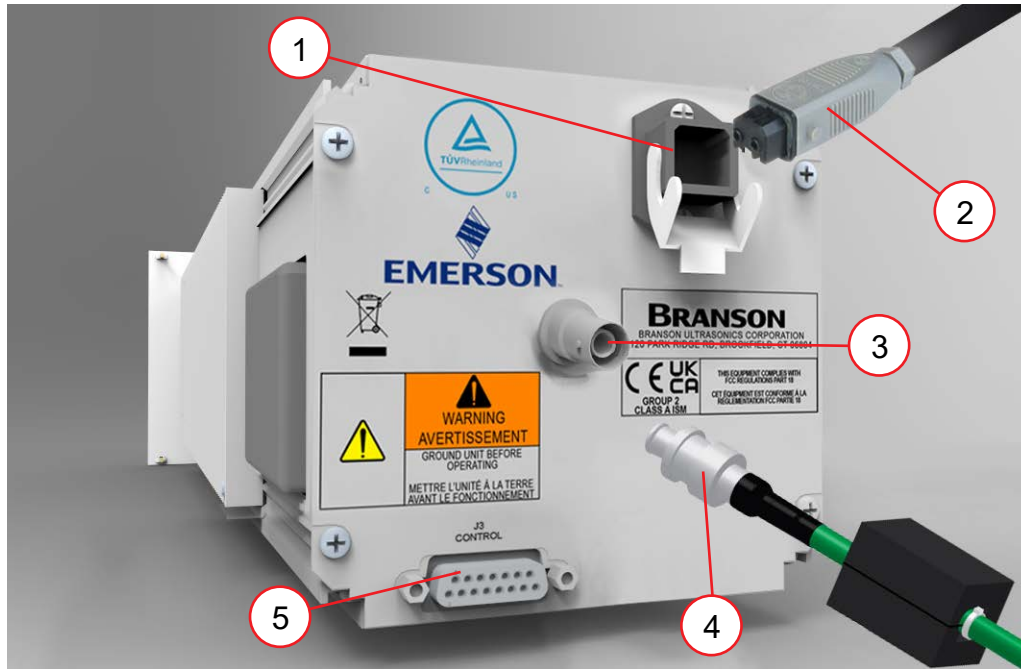
**Figure 5.4** LCD Viewing Angle



NOTICE	
	<p>Optimal viewing angle is 25° above the normal to the display (indicated by 0°).</p>

## 5.3.3 Electrical Connections

**Figure 5.5** DCX RM B Power Supply Connections




**Table 5.3** DCX RM B Power Supply Connections

Item	Description
1	Input Power Connector
2	Line Cord
3	RF Connector
4	RF Cable (Ferrite End)
5	User I/O Connectors

### 5.3.4 User I/O Connections

The user I/O is a standard interface for automation, provided on the power supply. It provides the ability to make your own interface for your automation, actuator interface, special control, or reporting needs. The interface cable has a DB15 male connector on one end, and wires on the other end. Pins are wired to ICEA standard color code (see [Figure 5.6 User I/O Cable Identification and Wire Color Diagram](#) and table [Table 5.4 User I/O Cable Pin Assignments](#)).

NOTICE	
	<p>Ensure all unused wires are properly isolated. Failure to do so may result in a power supply malfunction.</p>

Digital I/O functions can be configured to either active-high or active-low using the DCX RM B Power Supply web page interface. [Table 5.6 Available Digital Input Functions](#) to [Table 5.9 Available Analog Output Functions](#) list the input and output functions available on the DCX RM B Power Supply. See [Table 5.4 User I/O Cable Pin Assignments](#) for the user I/O pin assignments.

[Figure 5.7 Typical Digital I/O Wiring Examples](#) and [Figure 5.8 Typical Analog I/O Wiring Examples](#) show typical wiring examples.

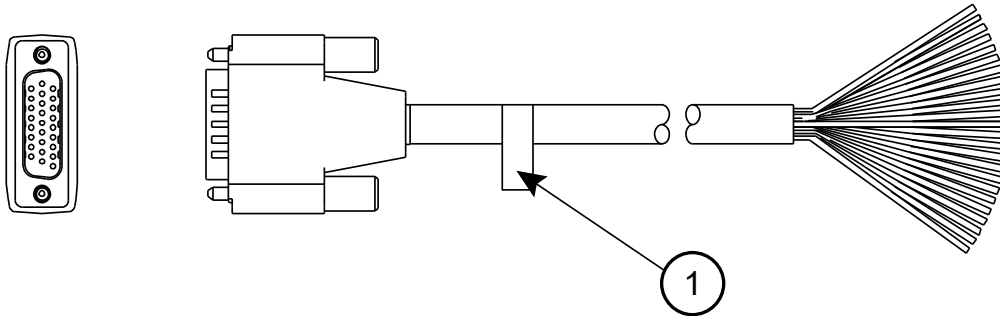
**Figure 5.6** User I/O Cable Identification and Wire Color Diagram

User I/O Cable

Stripped Jacket one end,

DB15 male connector other end

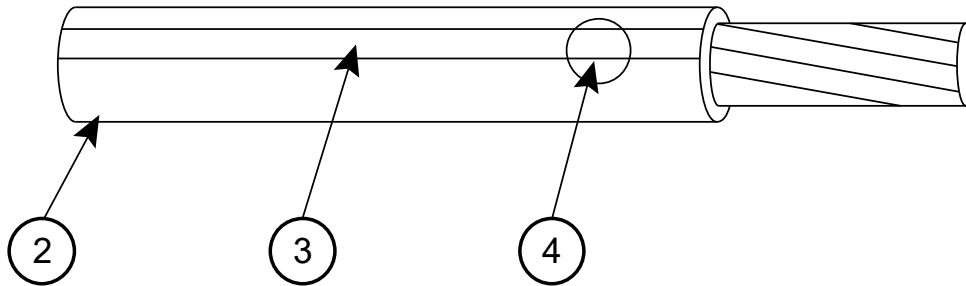
(cable length as ordered)



Wire Color Diagram

Two Colors = Insulator/Stripe

Three Colors = Insulator/Stripe/Dot



Item	Description
1	Part number
2	Insulation
3	Stripe
4	Dot

### 5.3.5 User I/O Cable Pin Assignments

**Table 5.4** User I/O Cable Pin Assignments

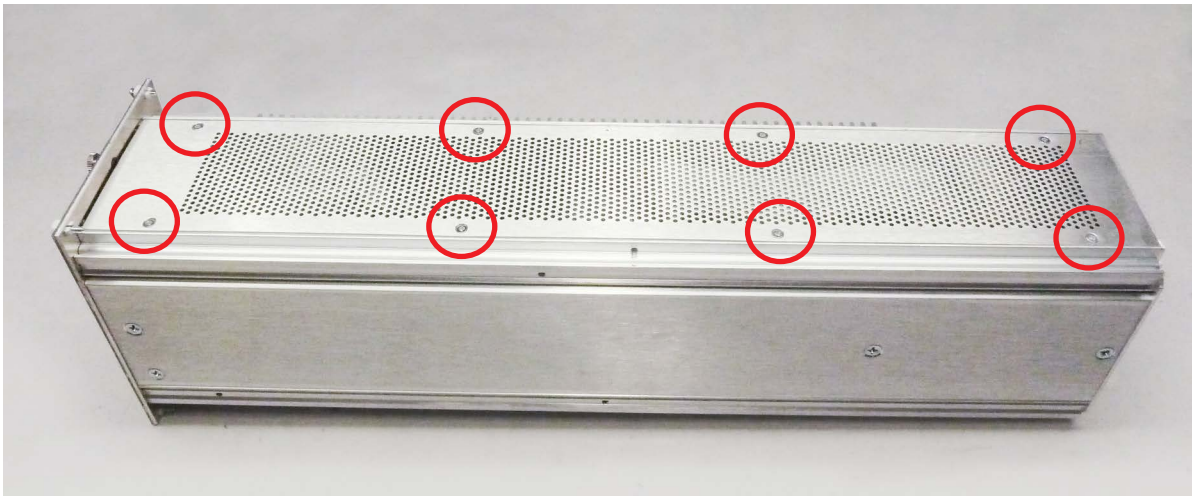
Pin	Input/Output Function	Signal Type	Signal Range	Color	
				ISO	IEC
1	Frequency Out	Analog Output	-10 V to +10 V	White	Black
2	Overload Inverted (Ready)	Digital Output	24 V $\pm$ 10%, 25 mA	Brown	Brown
3	GND	24 V Ground	0 V External	Green	Red
4	Overload	Digital Output	24 V $\pm$ 10%, 25 mA	Yellow	Orange
5	External Start	Digital Input	24 V $\pm$ 10%, 25 mA	Gray	Yellow
6	External Seek			Pink	Green
7	+10 V	10 V Reference	10 V	Blue	Blue
8	GND	24 V Ground	0 V External	Red	Violet
9	Sonics Active	Digital Output	24 V $\pm$ 10%, 25 mA	Black	Gray
10	Power Out	Analog Output	0 V to 10 V	Violet	White
11	+24 V	24 V Source	24 V External	Gray/ Pink	White/ Black
12	Frequency Offset	Analog Input	-10 V to +10 V	Red/ Blue	White/ Brown
13	External Reset	Digital Input	24 V $\pm$ 10%, 25 mA	White/ Green	White/ Red
14	Amplitude Out	Analog Output	0 V to 10 V	Brown/ Green	White/ Orange
15	Amplitude In	Analog Input	-10 V to +10 V	White/ Yellow	White/ Yellow

## 5.3.6 Frequency Output Setting

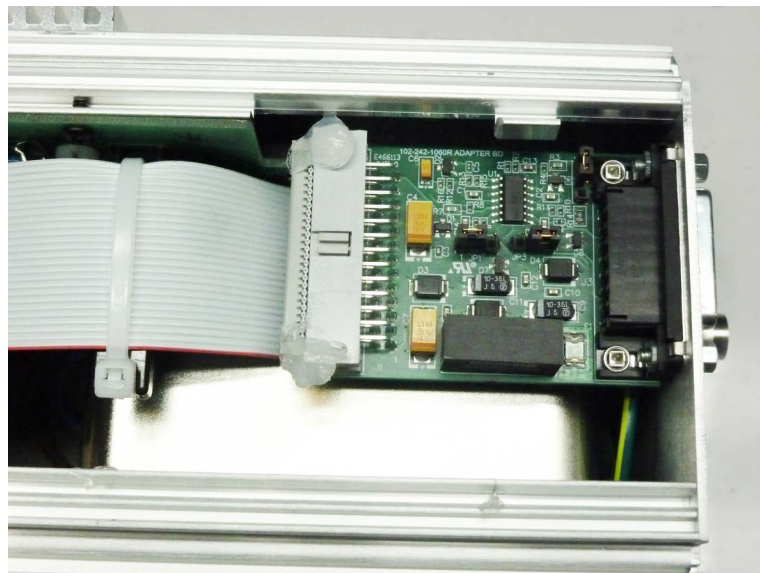
Follow this procedure to enable Frequency out on pin 1

**Table 5.5** To Enable Frequency Out on pin 1

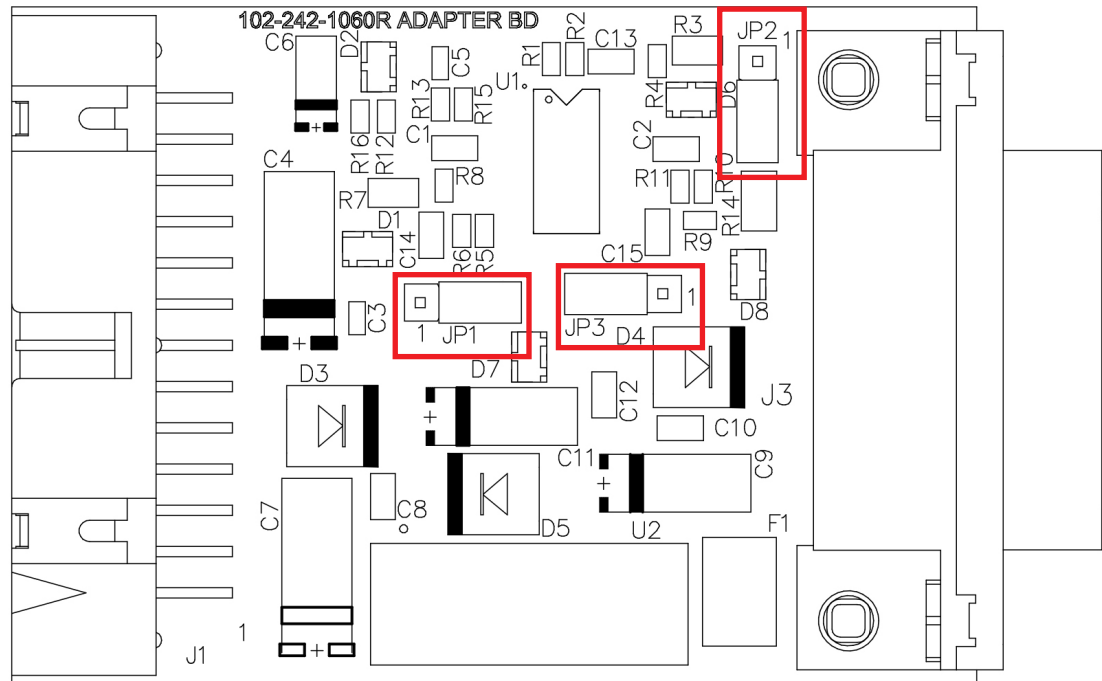
Step	Action
1	Remove the DCX from the rack and turn it upside down.
2	Locate and remove the 8 screws holding the cover.



Step	Heading
3	Locate the PC Board on the rear bottom of the DCX.



Step	Action
4	Locate jumpers JP1, JP2, and JP3.
5	Place jumper JP1 to 2-3, jumper JP2 to 2-3, and jumper JP3 to 2-3.



Step	Action
6	Place back the DCX cover and 8 screws.

### 5.3.7 Available Digital Input Functions

**Table 5.6** Available Digital Input Functions

Function	Description
External Reset	Resets alarm conditions.
External Seek	Activates ultrasonic energy at 10% amplitude for the purpose of finding the ultrasonic stack resonant frequency.

**Table 5.6** Available Digital Input Functions

Function	Description
External Start	Activates ultrasonic energy at the currently set amplitude. <b>NOTICE</b> DCX RM B Power Supply must be in ready mode before External Start.

## 5.3.8 Available Digital Output Functions

**Table 5.7** Available Digital Output Functions

Function	Description
Overload Alarm	Indicates an overload alarm has occurred.
Ready	Indicates the system is ready.
Sonics Active	Indicates sonics are active.

## 5.3.9 Available Analog Input Functions

**Table 5.8** Available Analog Input Functions

Function	Description	Valid Range	
Amplitude In	Controls the amplitude of ultrasonic energy that will be delivered by the power supply.	-8 V to +10 V* (10% to 100%)	
Frequency Offset	Controls the frequency offset to the power supply operating frequency. Actual offset depends on the power supply operating frequency:	-10 V to +10 V* (0 V is 0 offset)	
	<b>Frequency</b>		<b>Offset Range</b>
	20 kHz		±400 Hz
	30 kHz		±600 Hz
	40 kHz	±800 Hz	

\* If the input signals are not within their valid range, or if left unconnected, the power supply will use 50% amplitude and zero frequency offset, respectively.

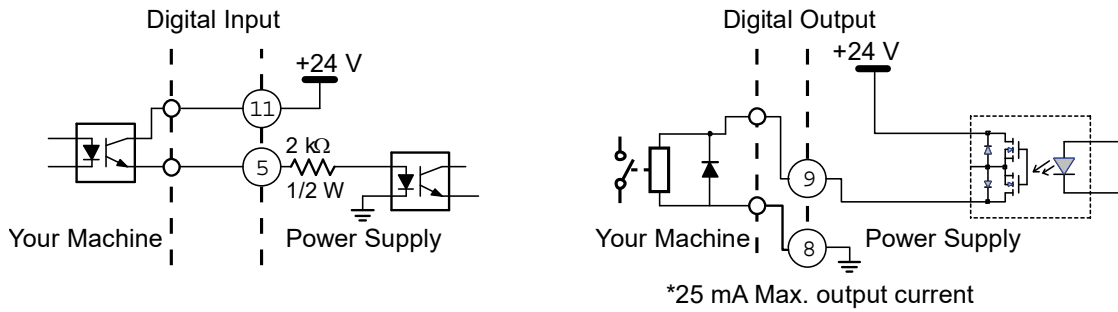
### 5.3.10 Available Analog Output Functions

**Table 5.9** Available Analog Output Functions

Function	Description			Valid Range
Amplitude Out	Provides a 0 V to 10 V output signal proportional to amplitude (0% to 100%).			0 V to 10 V (0% to 100%)
Power Out	Provides a 0 V to 10 V output signal proportional to ultrasonic power output (0% to 100%).			0 V to 10 V (0% to 100%)
Frequency Out	Provides a -10 V to +10 V output signal that indicates relative frequency in memory. Actual frequency depends on the power supply operating frequency:			-10 V to +10 V (5 V is 0 offset)
	<b>Frequency</b>	<b>Lower Limit (0 V)</b>	<b>Upper Limit (10 V)</b>	
	20 kHz	19,450 Hz	20,450 Hz	
	30 kHz	20,250 Hz	30,750 Hz	
	40 kHz	38,900 Hz	40,900 Hz	

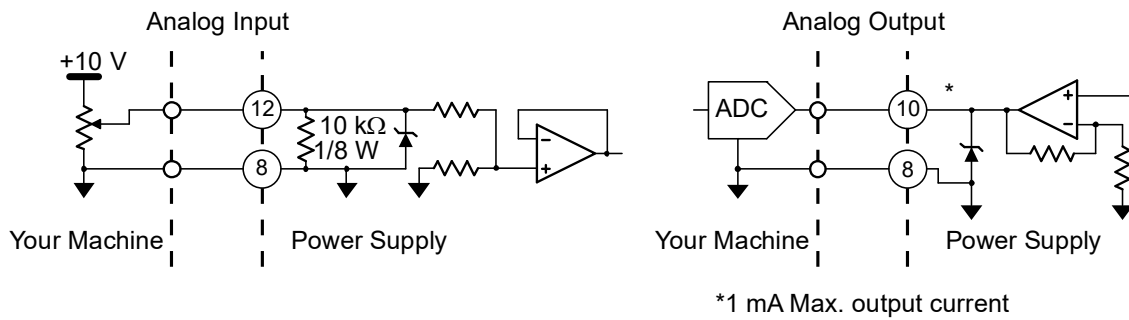
## 5.3.11 Typical Digital I/O Wiring Examples

**Figure 5.7** Typical Digital I/O Wiring Examples



## 5.3.12 Typical Analog I/O Wiring Examples


**Figure 5.8** Typical Analog I/O Wiring Examples





## 5.3.13 Output Power (RF Cable) Connection

Ultrasonic energy is delivered to the SHV connector on the power supply, which is then transmitted to the converter via the RF cable. The RF connector is located on the rear panel of the power supply.

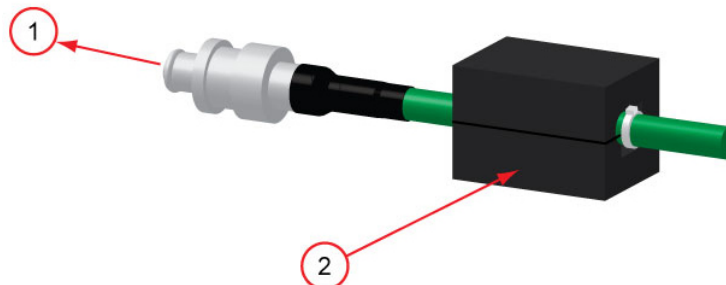
To reduce electromagnetic interference (EMI), RF cables are equipped with a ferrite core (plastic case) on one end. This end is meant to be connected to the power supply.

WARNING	High Voltage Hazard
	Operating the System with the RF Cable disconnected or damaged can present an electrical shock hazard.

WARNING	High Voltage Hazard
	To avoid the possibility of electrical shock, converters need to be properly grounded.

NOTICE	
	To avoid the possibility of EMI interference, ensure the RF connection to the power supply is made with the cable end that has the ferrite core box attached (see <a href="#">Figure 5.9 RF Cable Connection</a> ).




**Figure 5.9** RF Cable Connection



**Table 5.10** RF Cable Connection

Item	Description
1	To Power Supply
2	Ferrite Core Box

## 5.3.14 Input Power Connection

<b>WARNING</b>	<b>High Voltage Hazard</b>
	<p>Ensure all electrical power is off when wiring input power to your DCX RM B Power Supply power connector.</p> <p>To prevent the possibility of an electrical shock, ground the power supply by securing an AWG #14 grounded conductor to the ground screw located next to the air outlet</p>
<b>WARNING</b>	<b>High Voltage Hazard</b>
	<p>If miss-wired, the power supply can present an electrical shock hazard.</p>
<b>NOTICE</b>	
	<p>The power supply can be permanently damaged if it is connected to the incorrect line voltage, or if the connection is mis-wired.</p>

## 5.4 Power Supply Configuration

### 5.4.1 Selecting the Alarm Mode

The DCX RM B Power Supply activates ultrasonic power after receiving an External Start signal. Ultrasonic power remains on until you turn off the power supply or the External Start signal. The DCX RM B Power Supply response to alarm conditions can be configured to operate in one of two modes:

- **Latching:** In this mode the DCX RM B Power Supply requires alarm conditions to be reset before a new weld cycle can begin. To reset alarm conditions while in this mode, either press the front panel Reset key or send an External Reset signal using the user I/O connector
- **Non-Latching:** In this mode the DCX RM B Power Supply does not require alarm conditions to be reset, and new weld cycle can begin upon receiving an External Start signal


The alarm mode is factory-set to non-latching. For instruction on how to change the alarm mode refer to [7.4 Configuring the Power Supply Registers](#) in [Chapter 7: Operation](#) and to your DCX Series Web Page Interface Instruction Manual (4000843).

### 5.4.2 Configuring the Power Supply


Certain power supply configurations can be modified from the factory setting if needed. Although not usually requiring modifications from the factory setting, the following features are selectable:


- **Amplitude control:** Allows for varying the amplitude (10% to 100%) using the front panel LCD, the web page interface, or by way of external controls (analog signal applied through the user I/O analog input)
- **Latching Alarms:** Provides an option for selecting the power supply alarms to be latching (reset required) or non-latching (reset by reapplying the start signal)
- **Start Ramp Time:** Provides a selection for different start ramp times. This controls how fast the amplitude of the horn rises from zero to the currently set amplitude. Long ramp times may be useful when using large horns or high gain stacks
- **End of Weld Frequency Store:** Provides an option for selecting if the stack frequency is stored at the end of each weld cycle
- **Seek Ramp Time:** Provides a selection for different power supply seek ramp times
- **Timed Seek:** Provides an option for monitoring, and storing the operating frequency at timed intervals (60 seconds). Periodic frequency seeks may be helpful when welder is not used for long periods of time. Seeks are timed from the moment sonics was last activated
- **Seek Time:** Provides an option for selecting seek duration
- **Frequency Offset:** Allows for varying the start frequency by way of external controls (analog signal applied through the user I/O analog input) or setting a fixed value using the web page interface. This is useful for certain applications, where the force imparted on the fixture or anvil causes a frequency shift in the stack's operation


For instruction on how to change the power supply settings refer to [7.4 Configuring the Power Supply Registers](#) in [Chapter 7: Operation](#) and to your DCX RM B Power Supply Web Page Interface Instruction Manual (4000843).

NOTICE	
	Consult with Branson before changing any default factory setting.

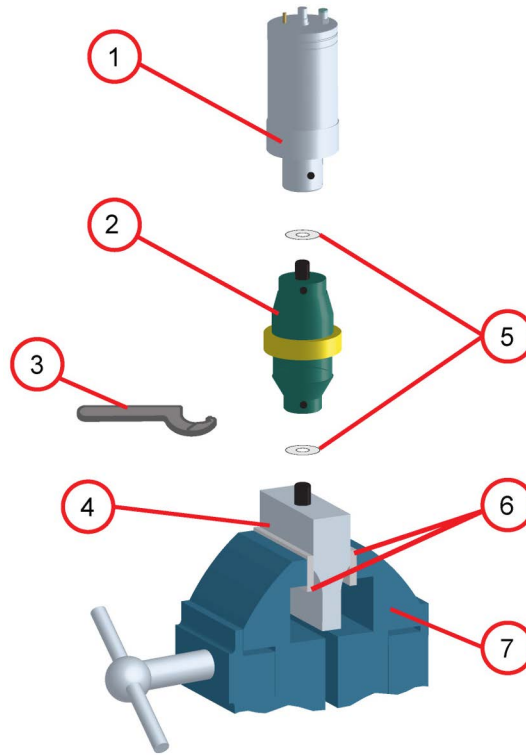
## 5.5 Assembling the Acoustic Stack

CAUTION	General Warning
	The following procedure must be performed by a setup person. If necessary, secure the largest portion of a square or rectangular horn in a soft jawed vise. NEVER attempt to assemble or remove a horn by holding the converter housing or the booster clamp ring in a vise.

CAUTION	General Warning
	Do not use silicone grease with Mylar <sup>®</sup> plastic film washers. Use only 1 (one) Mylar <sup>®</sup> plastic film washer of the correct inside and outside diameters at each interface.

NOTICE	
	The use of a Branson torque wrench or the equivalent is recommended. P/N 101-063-787 for 20 kHz, and 30 kHz systems and 101-063-618 for 40 kHz systems.

**Figure 5.10** Assembling the Acoustic Stack



**Table 5.11** Acoustic Stack Description

Item	Description
1	Converter
2	Booster
3	Spanner (provided)
4	Horn
5	See stack assembly procedure
6	Vise Jaw protectors (aluminum or soft metal)
7	Vise

**Table 5.12** Stack Torque Values

Frequency	Torque
20 kHz	220 in·lb (24.85 N·m)
30 kHz	185 in·lb (21 N·m)
40 kHz	95 in·lb (10.73 N·m)

**Table 5.13** Tools

Tool	EDP Number
20 kHz, and 30 kHz Torque Wrench Kit	101-063-787
40 kHz Torque Wrench	101-063-618
20 kHz Spanner Wrench	101-118-039
30 kHz Spanner Wrench	201-118-033
40 kHz Spanner Wrench	201-118-024
Silicone Grease	101-053-002
Mylar <sup>®</sup> Plastic Film Washers (20 kHz)	100-063-357
Mylar <sup>®</sup> Plastic Film Washers (30 kHz)	100-063-632

### 5.5.1 For a 20 kHz System

**Table 5.14** 20 kHz System

Step	Action
1	Ensure that the mating surfaces of the converter, booster, and horn are clean, and that the threaded holes are free of foreign material.
2	Install a single Mylar® plastic film washer (matching the size of the washer to the stud) to each interface.
3	Assemble the converter to the booster and the booster to the horn.
4	Torque to 220 in·lb (24.85 N·m) at each interface.

### 5.5.2 For a 30 kHz System

**Table 5.15** 30 kHz System

Step	Action
1	Ensure that the mating surfaces of the converter, booster, and horn are clean, and that the threaded holes are free of foreign material.
2	Install a single Mylar® plastic film washer (matching the size of the washer to the stud) to each interface.
3	Assemble the converter to the booster and the booster to the horn.
4	Torque to 185 in·lb (20.90 N·m) at each interface.

### 5.5.3 For a 40 kHz System

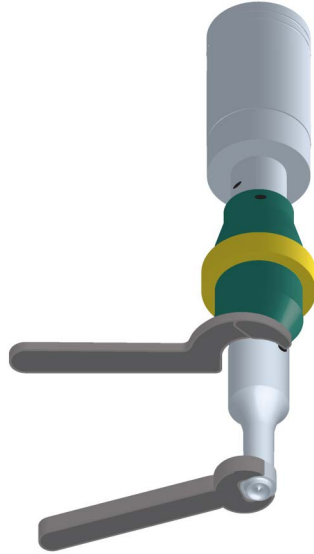
**Table 5.16** 40 kHz System

Step	Action
1	Ensure that the mating surfaces of the converter, booster, and horn are clean, and that the threaded holes are free of foreign material.
2	Coat each interface surface with a thin film of silicon grease - but do not apply silicon grease to a threaded stud or tip.
3	Assemble the converter to the booster and the booster to the horn.
4	Torque to 95 in·lb (10.73 N·m) at each interface.

## 5.5.4 Connecting Tip to Horn

1. Ensure that the mating surfaces of the tip and horn are clean. Remove any foreign matter from the threaded stud and hole
2. Hand assemble the tip to the horn. Assemble dry. Do not use any silicone grease
3. Use the spanner wrench and an open-end wrench (refer to [Figure 5.11 Connecting Tip to Horn](#)) and tighten to the following torque tip specifications:

**Figure 5.11** Connecting Tip to Horn



**Table 5.17** Tip to horn torque values

Tip Thread	Torque
1/4 - 28	110 in·lbs (12.42 N·m)
3/8 - 24	180 in·lbs (20.33 N·m)

## 5.6 Converter Cooling

Converter performance and reliability can be adversely affected if the converter ceramics are subjected to temperatures above 140° F (60° C). The converter front driver temperature should not exceed 122° F (50° C).

To prolong converter life and maintain a high degree of system reliability, the converter should be cooled with clean, dry, compressed air, particularly if your application calls for continuous ultrasonic operation. Converter cooling is especially critical in 40 kHz applications.

Use one of the following procedures to determine if a converter is operating close to the maximum allowable temperature. Check converter temperature immediately after substantial machine operation and without power applied to the horn.

- Press a pyrometer probe (or similar temperature measuring device) against the front driver of the converter assembly. Wait for the probe to reach the temperature of the shell. If the temperature is 120° F (49° C) or higher, the converter requires a cooling air stream
- If a temperature measuring device is unavailable, use your hand to feel the shell of the converter. If the converter is hot to touch, the converter requires a cooling air stream

High duty cycles require additional cooling for the converter. System average power must be limited to the specified continuous maximum. Higher peak power, up to the maximum acceptable power limit, with an on time of up to 10 seconds may be obtained, if appropriate off time ensures that, on average, the continuous duty maximum power is not exceeded.

**Table 5.18** Continuous Duty Max. Power & Full Power Duty Cycle

Model	Power	Continuous Duty. Max. Power	Full Power Duty Cycles
20 kHz	1100 W	330 W	1 second on, 3 seconds off. (25% Duty Cycle)
	2200 W	660 W	
	4000 W	1200 W	
30 kHz	1500 W	460 W	
40 kHz	800 W	240 W	

If converter cooling is required, use the following steps:

**Table 5.19** Converter Cooling Procedure

Step	Action
1	Start with a 50 psi (345 kPa) air source or higher from a 0.06 in (1.5 mm) I.D. orifice.
2	Perform a run of welding operations.
3	Immediately after completing the welding run, check the converter temperature.
4	If the converter is still too hot, increase the diameter of the orifice in small increments until the temperature falls within the ranges in the chart.

A 0.06 in (1.5 mm) orifice at 50 psi (345 kPa) will result in a reading of 80 ft<sup>3</sup> (2.26 m<sup>3</sup>) per hour. This should be sufficient to cool most operations requiring a cooling air stream. In continuous welding operations, or applications with longer duty cycles, it may be necessary to cool the horn as well as the converter. Horns may require cooling because of the heat transfer from contacting the work piece.

## **5.7 Testing the Installation**

To test the power supply follow the procedure described in [7.7 Ultrasonics Test Procedure](#) in [Chapter 7: Operation](#).

## 5.8 Still Need Help?

Branson is pleased that you chose our product and we are here for you! If you need parts or technical assistance with your DCX RM B Power Supply system, call your local Branson representative. Please refer to [1.3 How to Contact Branson](#) for a list of Branson key contacts.

---


# **Chapter 6: Converters and Boosters**

---

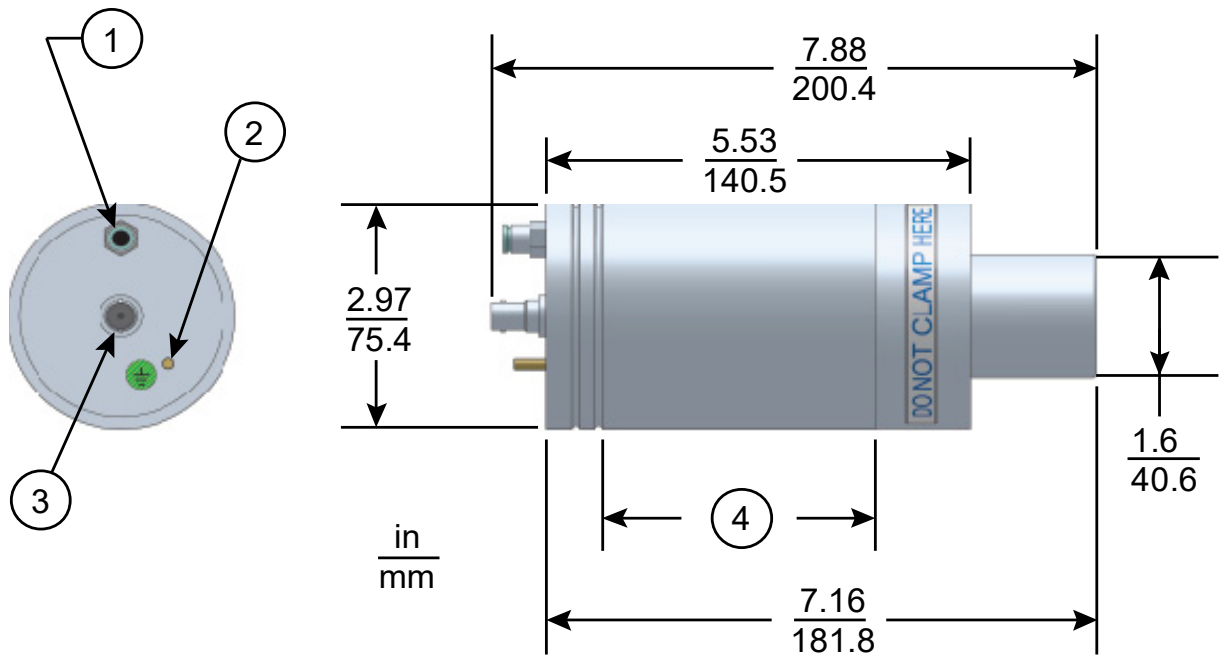
**6.1 Converters and Boosters . . . . . 74**

## 6.1 Converters and Boosters

A variety of converters and boosters available for use with the DCX RM B Power Supply are illustrated in the following pages.

<b>WARNING</b>	<b>High Voltage Hazard</b>
	To avoid the possibility of electrical shock, converters need to be properly grounded.

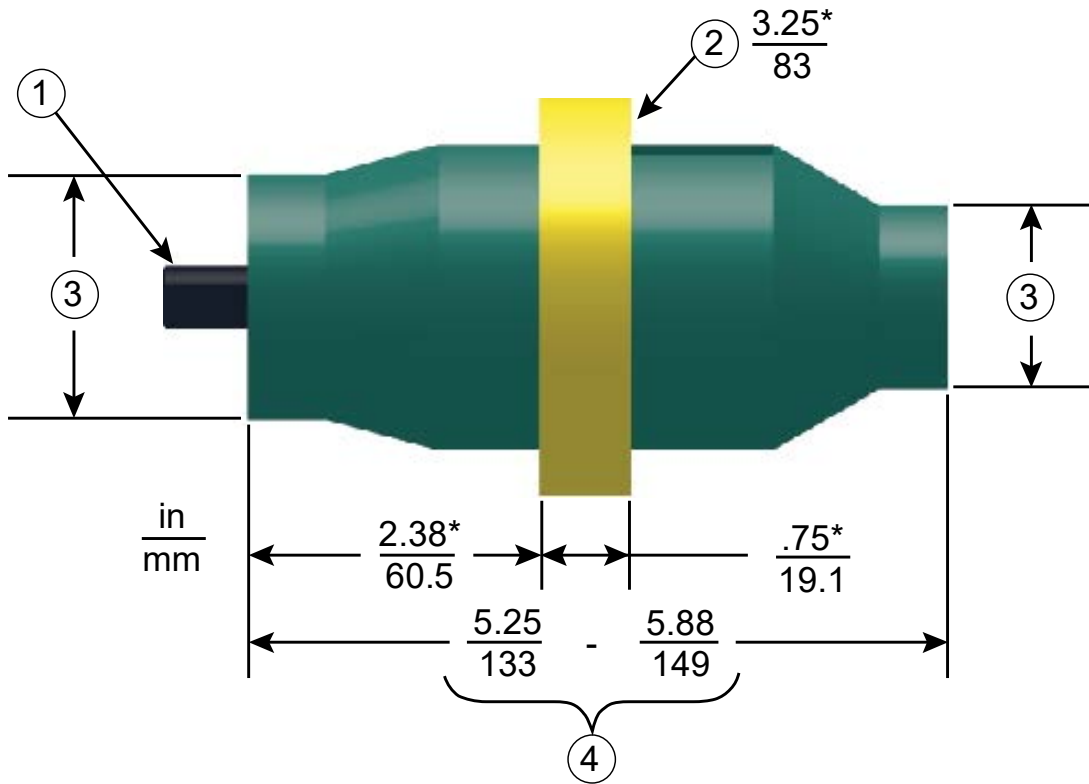
**Figure 6.1** 20 kHz typical Converter Dimensions



**Table 6.1** 20 kHz Converter

Item	Description
1	Air inlet
2	Ground stud
3	SHV connector
4	Grip area

**Figure 6.2** 20 kHz Booster Dimensions

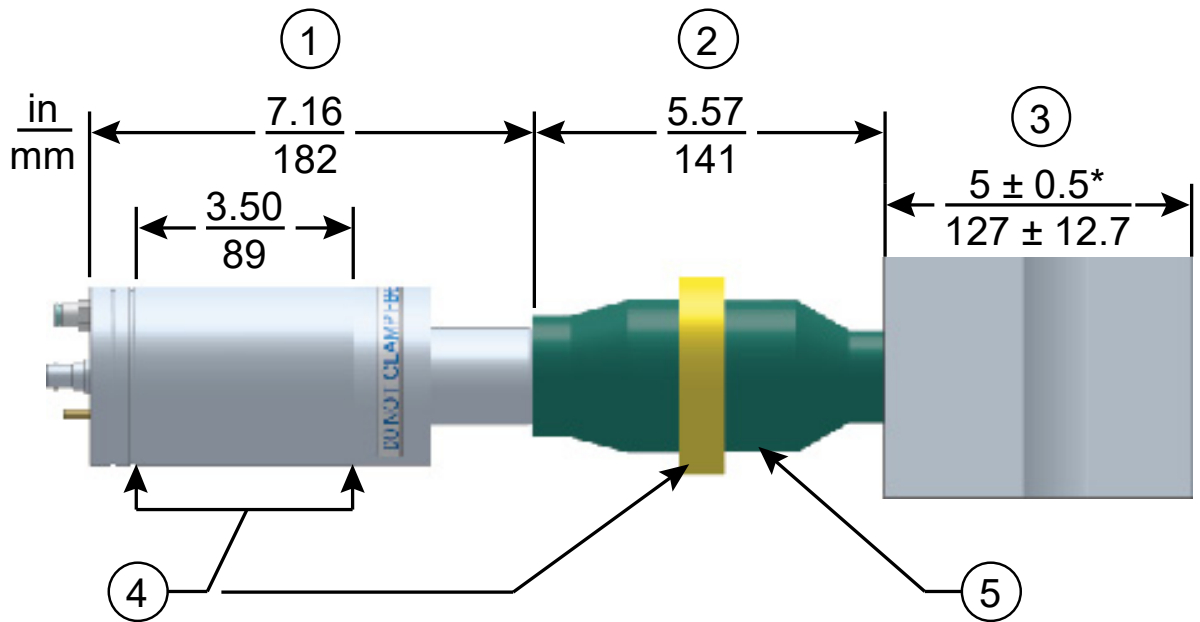


**Table 6.2** 20 kHz Booster

Item	Description
1	1/2 - 20 x 1 - 1/4 stud (Ti boosters) 1/2 - 20 x 1 - 1/2 stud (Al boosters)
2	Grip Ring Diameter
3	Variable
4	Varies with tuning and gain

\* These dimensions do not vary.

**Figure 6.3** 20 kHz Converter/Booster/Horn, Typical Dimensions



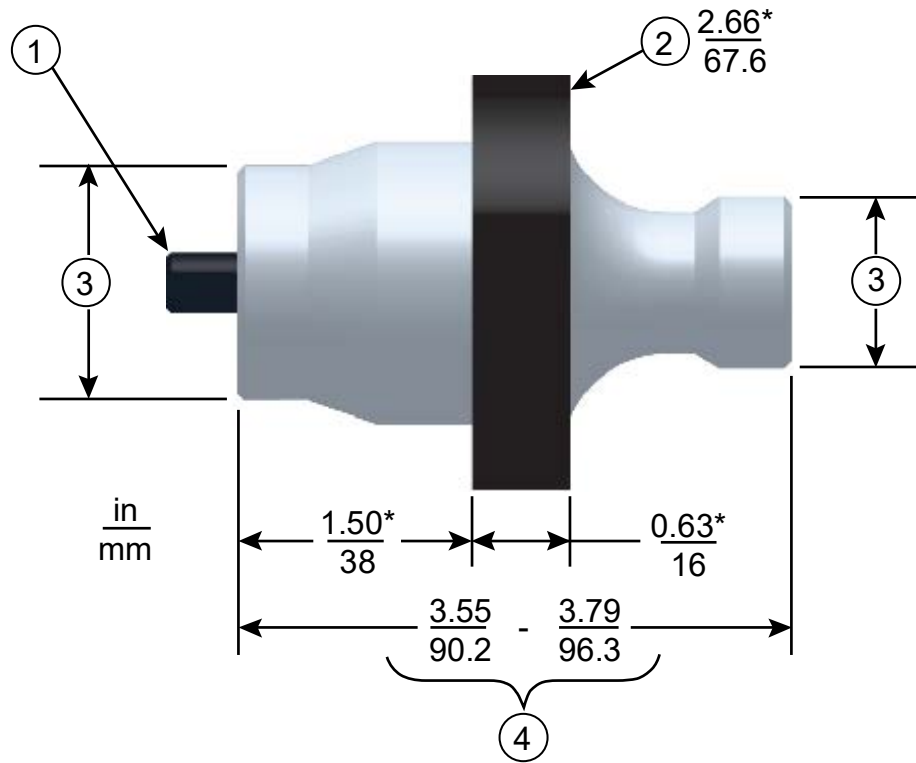
**Table 6.3** 20 kHz Converter/Booster/Horn

Item	Description
1	Converter
2	Booster
3	One-half wavelength horn
4	Recommended clamping area
5	Booster front end diameter will vary with amplitude

\* Overall horn length can vary beyond these typical dimensions depending on the application.



**Figure 6.5** 30 kHz Booster Dimensions

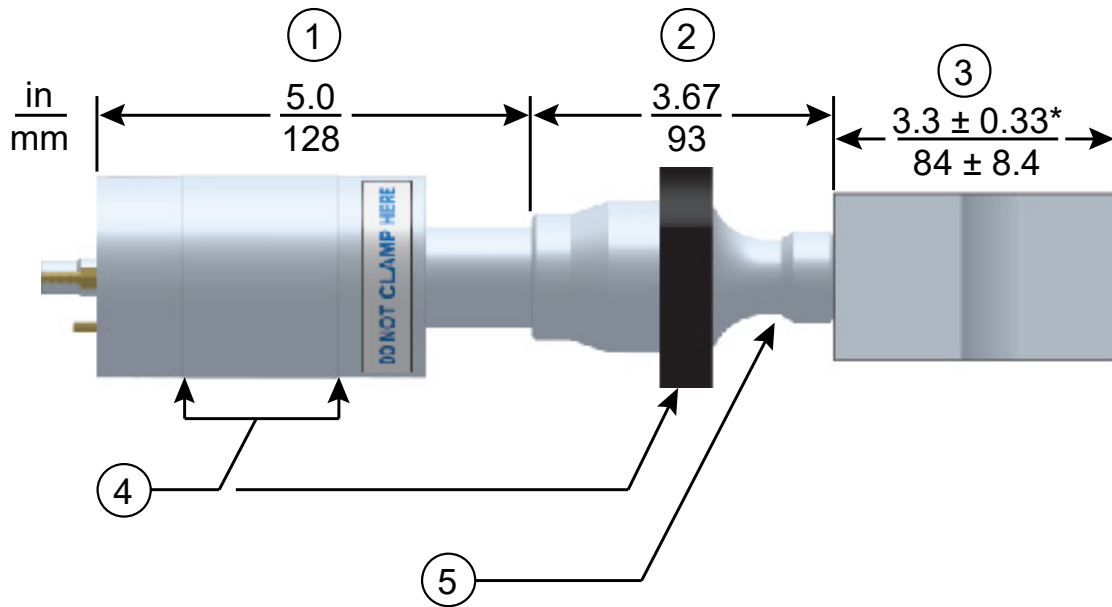


**Table 6.5** 30 kHz Booster

Item	Description
1	3/8 - 24 x 1 - 1/4 stud
2	Grip Ring Diameter
3	Variable
4	Varies with tuning and gain

\* These dimensions do not vary.

**Figure 6.6** 30 kHz Converter/Booster/Horn, Typical Dimensions

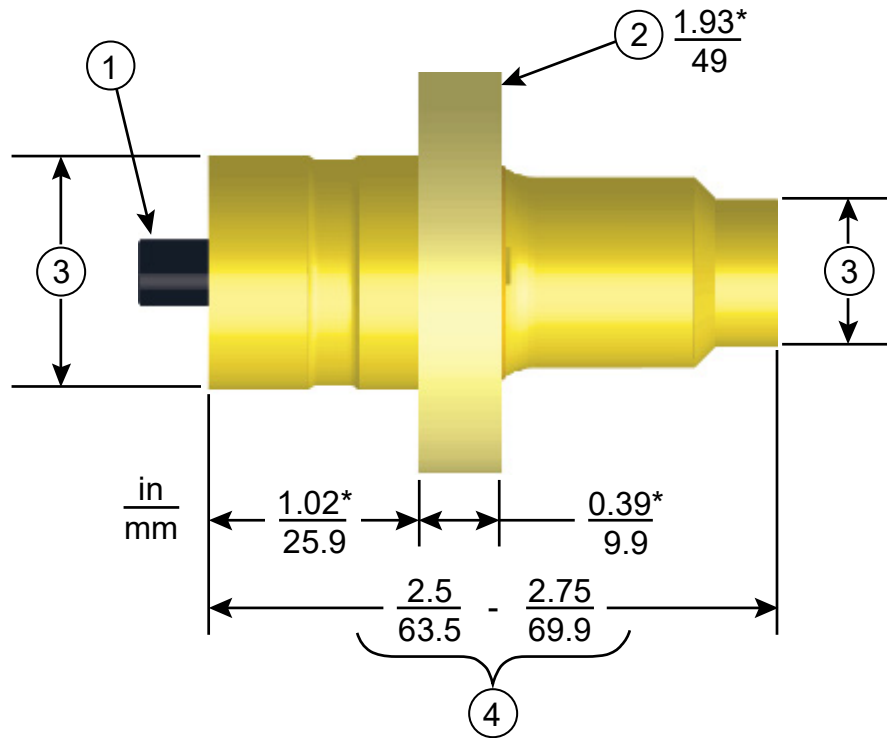


**Table 6.6** 30 kHz Converter/Booster/Horn

Item	Description
1	Converter
2	Booster
3	One-half wavelength horn
4	Recommended clamping area
5	Booster front end diameter will vary with amplitude

\* Overall horn length can vary beyond these typical dimensions depending on the application.

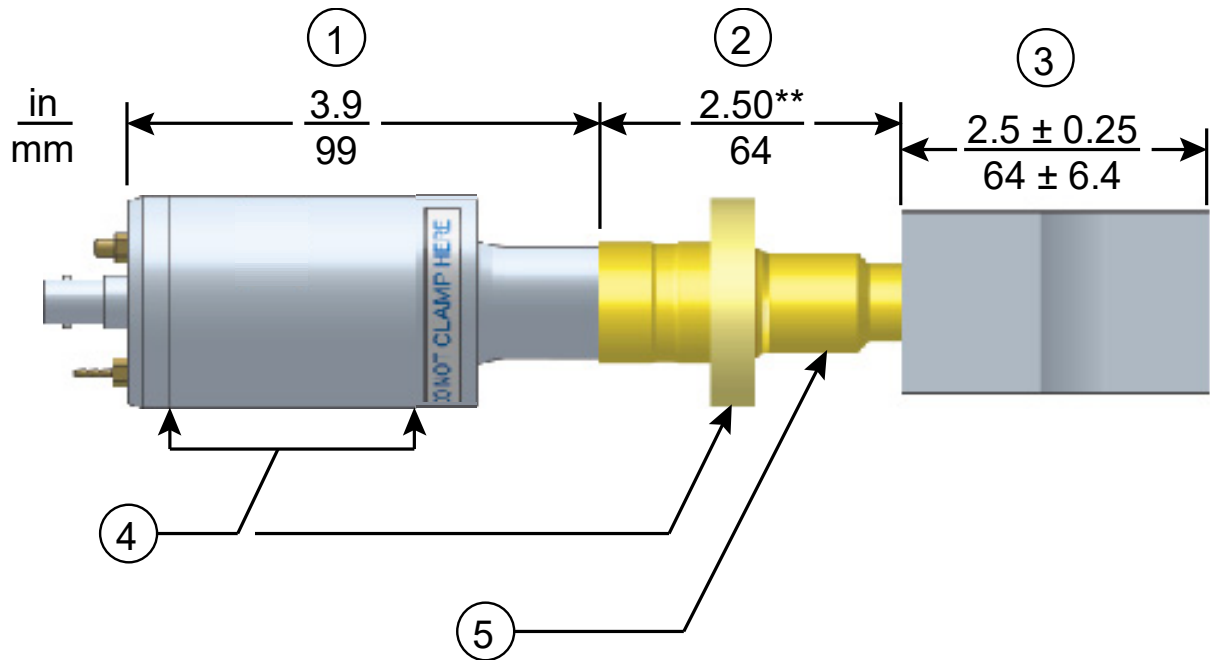
**Figure 6.7** 40 kHz Booster Dimensions



**Table 6.7** 40 kHz Booster

Item	Description
1	M8 x 1 - 1/4 stud (Ti boosters) M8 x 1 - 1/2 stud (Al boosters)
2	Grip ring diameter
3	Variable
4	Varies with tuning and gain

**Figure 6.8** 40 kHz Converter/Booster/Horn, Typical Dimensions



**Table 6.8** 40 kHz Converter/Booster/Horn

Item	Description
1	Converter
2	Booster
3	One-half wavelength horn
4	Recommended clamping area
5	Booster front end diameter will vary with amplitude

\* Overall horn length can vary beyond these typical dimensions depending on the application.

\*\* Dimension varies with tuning and gain.

## 6.1.1 Component Functional Description

### Ultrasonic Stack

#### Converter

The converter is mounted in the customer's automation as part of the ultrasonic stack. The ultrasonic electrical energy from the power supply is applied to the converter (sometimes called the transducer). This transforms the high frequency electrical oscillations into mechanical vibrations at the same frequency as the electrical oscillations. The heart of the converter are piezoelectric ceramic elements. When subjected to an alternating voltage, these elements alternately expand and contract, resulting in better than 90% conversion of electrical to mechanical energy.

#### Booster

It is important to be able to modify the horn face amplitude for successful ultrasonic assembly. The booster provides a means to modify the amplitude. It is designed to couple different ratios of ultrasonic energy to the horn, which will in turn increase or decrease the amplitude at the face of the horn. This is accomplished by varying the ratios of the masses of the input and output half sections of the booster.

The booster is a resonant half-wave section of aluminum or titanium. It is mounted between the converter and the horn, as part of the ultrasonic stack. It also provides a clamping point for rigid stack mounting.

#### Horn

The horn is selected or designed for a specific application. Each horn is tuned typically as a half-wave section that applies the necessary force and vibration uniformly to the parts to be assembled. It transfers ultrasonic vibrations from the converter to the workpiece. The horn is mounted to the booster as part of the ultrasonic stack.

Depending on their profile, horns are referred to as stepped, conical, exponential, bar, or catenoidal. The shape of the horn determines the amplitude at the face of the horn. Depending on the application, horns can be made from titanium alloys, aluminum, or steel. Titanium alloys are the best materials for horn fabrication due to their high level of strength and low loss. Aluminum horns are usually chrome- or nickel-plated or hard-coated to reduce wear. Steel horns are for low amplitude requiring hardness, such as ultrasonic insertion applications.

## Solid Mount Boosters

The solid mount booster is a one-half wave-length resonant section made exclusively of titanium. It is mounted between the converter and the horn, modifying the amplitude of vibration applied to the horn and providing a clamping point.

The solid mount booster is superior to prior versions in that deflection is minimized. This is the result of a redesigned clamp-ring which employs a metal-to-metal press fit rather than an O-ring assembly.

The advantage this booster offers is its improved rigidity. For continuous applications, this means more energy delivered to the product, while in plunge applications, improved alignment is possible. The solid mount provides improved positional alignment and will benefit continuous applications where high force, high side load, or high cycle rates are necessary. In plunge welding applications, overall deflection is reduced by an average of 0.0025 in. (0.064 mm) over a wide variety of materials, joint designs, and operating conditions. The results of this testing in combination with information drawn from field testing indicate that the solid mount will benefit plunge applications where precision alignment is necessary (such as staking, swaging, or insertion) or where concentricity/parallelism is critical.


---

## **Chapter 7: Operation**

---

<b>7.1</b>	<b>Activating Ultrasonic Power</b> .....	<b>86</b>
<b>7.2</b>	<b>Setting the Amplitude</b> .....	<b>87</b>
<b>7.3</b>	<b>Resetting the Power Supply Alarms</b> .....	<b>89</b>
<b>7.4</b>	<b>Configuring the Power Supply Registers.</b> .....	<b>90</b>
<b>7.5</b>	<b>LCD Bar-Graph.</b> .....	<b>94</b>
<b>7.6</b>	<b>Web Page Interface.</b> .....	<b>97</b>
<b>7.7</b>	<b>Ultrasonics Test Procedure</b> .....	<b>101</b>

## 7.1 Activating Ultrasonic Power

NOTICE	
	There is a 2 seconds power-up delay before system is in ready mode.

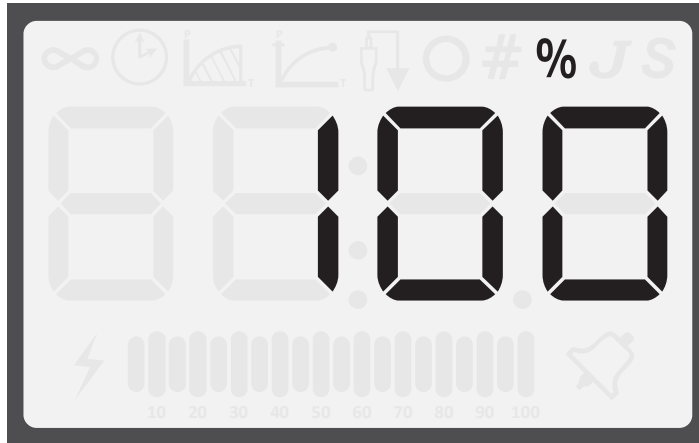
On DCX RM B Power Supply, ultrasonic power activates after receiving an External Start signal at the corresponding user I/O. Ultrasonic power remains On until you turn Off the power supply or the External Start signal. For default user I/O assignment see [5.3.4 User I/O Connections](#). For information on configuring the power supply user I/O refer to your DCX Series Web Page Interface Instruction Manual.

## 7.2 Setting the Amplitude

### 7.2.1 Using the Front Panel Controls

At power up the DCX RM B Power Supply will display the last amplitude setting on the LCD. It can also be set to show weld mode.

**Figure 7.1** LCD at Power Up



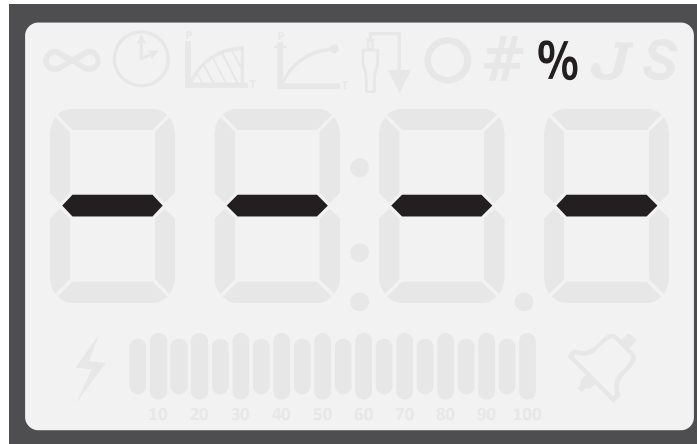
**Table 7.1** Setting the Amplitude Using the Front Panel Controls

Step	Action	Reference
1	Press the Configuration key until the percentage icon (%) and no mode icons are displaying on the LCD.	
2	<p>Press and release the Up or Down arrow keys to select the desired amplitude at 1% increments.</p> <p>Press and hold down the Up or Down arrow keys and the Amplitude will auto increment at 1% increments every quarter of a second.</p> <p>After holding down an arrow key for four straight seconds, the amplitude will auto increment at 5% increments every quarter of a second.</p>	

## 7.2.2 Using External Amplitude Control

When External Amplitude Control is enabled, the front panel amplitude control is disabled and the LCD displays four dashes (see [Figure 7.2 LCD when in External Amplitude Control Mode](#) below).

**Figure 7.2** LCD when in External Amplitude Control Mode



The ultrasonic amplitude can be controlled using one of the two analog input pins on the user I/O connector (pins 17 and 18).

## 7.2.3 Using the Web Page Interface


The ultrasonic amplitude can be set to a user specified value using the web page interface. For more information, refer to the DCX Series Web Page Interface Instruction Manual.

## 7.3 Resetting the Power Supply Alarms

You need to reset the weld system when you get an overload. When there is an overload, the alarm icon appears on the front panel LCD and the General Alarm output on the user I/O connector becomes active. The procedure for resetting the power supply depends on the power supply alarm settings. Refer to [Table 7.2 Resetting the DCX RM B Power Supply](#) for reset procedures.

**Table 7.2** Resetting the DCX RM B Power Supply

Alarm Setting	Reset Procedure
Latching Alarms	Press the front panel Reset key. You can also send an External Reset signal.
Non-Latching Alarms	Remove and re-apply the start signal.

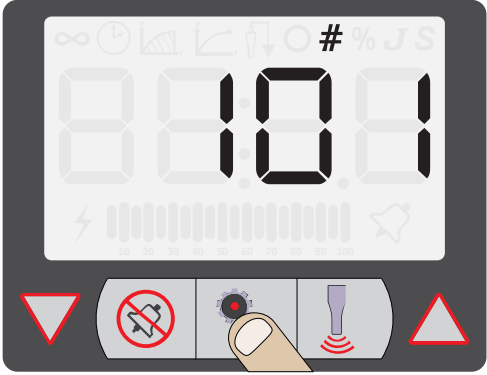

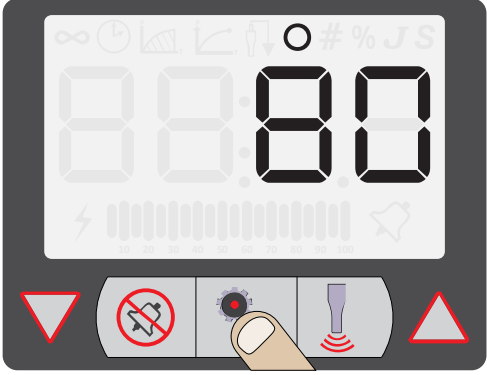
NOTICE	
	Alarm circuitry requires at least 20 ms before restarting ultrasonic power.

For more information on interfacing the DCX RM B Power Supply using the user I/O connections refer to [5.3.4 User I/O Connections](#) in [Chapter 5: Installation and Setup](#).



## 7.4 Configuring the Power Supply Registers

At power up the DCX RM B Power Supply will display the last amplitude setting, this is indicated by the percentage icon (%) on the LCD. Refer to [Figure 7.1 LCD at Power Up](#).

**Table 7.3** Steps to Configure the Power Supply Registers

Step	Action	Reference
1	<p>Press the Configuration key until the number icon (#) appears on the LCD.</p> <p>The power supply will display register 101 at every power up.</p>	 <p>The image shows a close-up of the LCD screen. At the top right, the number icon (#) is highlighted. The main display shows the number '101'. Below the screen, a finger is shown pressing the Configuration key (the central button with a gear icon).</p>
2	<p>Press and release the Up or Down arrow keys to select the desired register. For a detailed description of available registers refer to <a href="#">Table 7.4 Power Supply Registers</a>.</p>	 <p>The image shows the LCD screen with the number '108' displayed. The Up arrow key on the bottom panel is highlighted with a finger, indicating it has been pressed to change the register value.</p>
3	<p>Once you have reached the desired register, press the Configuration key. The register value will be displayed, this is indicated by the circle icon.</p>	 <p>The image shows the LCD screen with the number '80' displayed. The circle icon at the top right of the screen is highlighted, indicating that the register value has been successfully set.</p>

**Table 7.3** Steps to Configure the Power Supply Registers

Step	Action	Reference
4	<p>Press and release the Up or Down arrow keys to enter the desired value at 1 increments.</p> <p>Press and hold down the Up and Down arrow keys and the value will auto increment at 1 increments every quarter of a second.</p> <p>After holding down an arrow key for four straight seconds, the value will auto increment at 5 increments every quarter of a second.</p> <p>Or press the Reset key to enter the default value. For detailed default values of available registers refer to <a href="#">Table 7.4 Power Supply Registers</a>.</p>	
5	<p>Press the Configuration key to save the value. The current amplitude setting will be displayed only for continuous mode. For all the other modes, it will display the primary parameter of that mode.</p>	

## 7.4.1 Power Supply Registers

**Table 7.4** Power Supply Registers

Register	Description	Default Value	Max. Value	Min. Value
101	System software version	N/A	N/A	N/A
102	Bar graph identification after weld complete 0: Power 1: Frequency	0	1	0
104	External amplitude control - user analog input 0: Off 1: On	0	1	0
105	Amplitude ramp time (ms)	80	1000	10
106	Store frequency at end of weld 0: Off 1: On	1	1	0
107	Power up seek/scan 0: Off 1: Seek 2: Scan	1	2	0
108	Seek ramp time (ms)	80	1000	10
109	Timed seek (every 60 seconds) 0: Off 1: On	0	1	0
110	Seek time (ms)	500	1000	10
111	Frequency offset 0: Off 1: On	0	1	0
112	Frequency offset value			
	20 kHz	0	500	-500
	30 kHz		750	-750
40 kHz	1000		-1000	
115	Restore defaults 0: Off 1: Just weld preset 2: System defaults	0	2	0

**Table 7.4** Power Supply Registers

Register	Description	Default Value	Max. Value	Min. Value
116	IP address - 1	192	255	0
117	IP address - 2	168	255	0
118	IP address - 3	10	255	0
119	IP address - 4	100	255	0
120	Gateway for IP address 1	192	255	0
121	Gateway for IP address 2	168	255	0
122	Gateway for IP address 3	10	255	0
123	Gateway for IP address 4	1	255	0
124	Subnet mask for IP address 1	255	255	0
125	Subnet mask for IP address 2	255	255	0
126	Subnet mask for IP address 3	255	255	0
127	Subnet mask for IP address 4	0	255	0
128	DHCP settings 0: Server 1: Client 2: Static 3: Restore registers 116-128 to default	2	3	0
134	Backlight time-out (s) 0: Always on	600	9999	0
135	Auto scroll step size	5	50	1
139	MAC address 1	N/A	FFFF	0
140	MAC address 2	N/A	FFFF	0
141	MAC address 3	N/A	FFFF	0
157	Memory clear when external reset through I/O 0: No memory clear 1: Memory clear	0	1	0

## 7.5 LCD Bar-Graph

While ultrasonic power is active the LCD will always display the power value on the 20-segment LCD bar-graph as a percentage of the maximum output power.

At the end of a weld or test cycle, the bar-graph is factory set to represent the cycle's peak power as a percentage of the maximum output power.

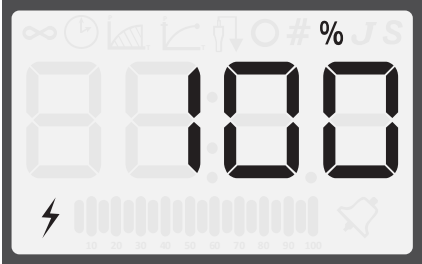
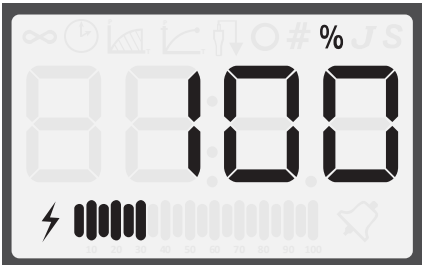
The power supply can also be configured to show a single bar on the LCD bar-graph to represent the stack operating frequency stored at the end of each weld or test cycle. This option can be used to troubleshoot operating frequency changes as a result of heating effects, coupling, tooling wear, etc.

For information on how to set the power supply registers see [7.4 Configuring the Power Supply Registers](#).

### 7.5.1 Power Bar-Graph Interpretation


The lightning bolt left of the bar-graph indicates ultrasonic power is running. Each of the segments represent 5% increments of the maximum output power. The segments will only appear if the output power has exceeded the value represented. For example if the power is 4% only the lightning bolt will be on. When it reaches 5% the first bar-graph segment will appear.

**Table 7.5** Power Bar-Graph Interpretation Examples

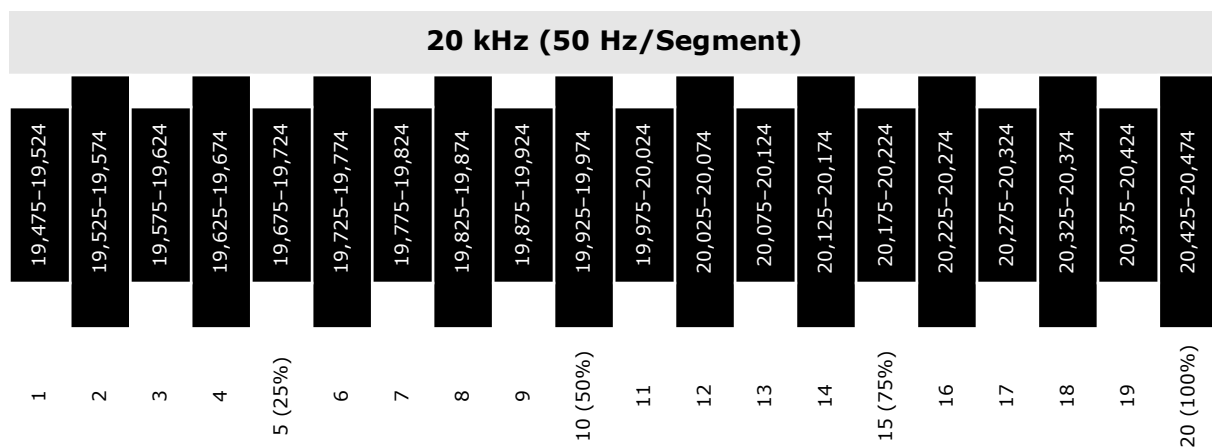
Description	Reference
<p>In this example only the lightning bolt appears left of the bar-graph. This means power is between 0% and 5%. If the power supply is 800 W the actual output power is between 0 W and 40 W.</p>	
<p>In this example the first six segments appear on the bar-graph. This means power is between 30% and 35%. If the power supply is 800 W, the actual output power is between 240 W and 280 W.</p>	

## 7.5.2 Frequency Bar-Graph Interpretation

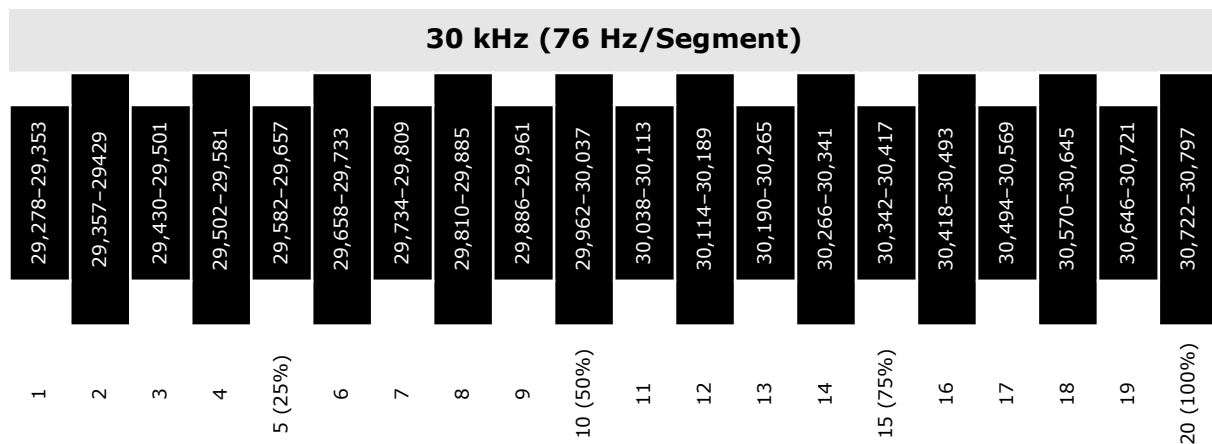
The actual frequency depends on the power supply's operating frequency. Use tables below to interpret frequency bar-graph readings.

NOTICE	
	<p>If there is a test overload or an external memory reset signal is received, then the 50% segment will be displayed and blinking.</p>

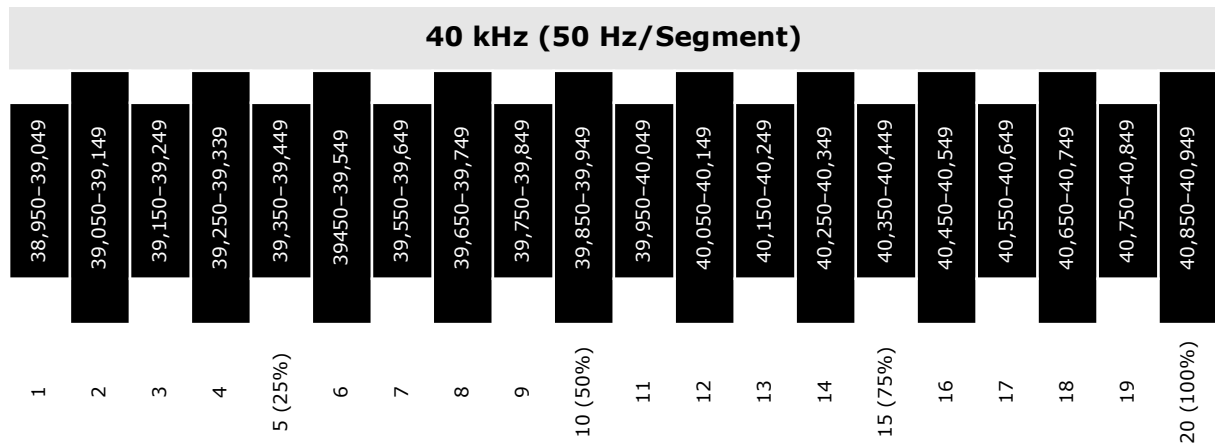
**Table 7.6** Frequency Bar-Graph Interpretation - 20 kHz (50 Hz Segment)



**Table 7.7** Frequency Bar-Graph Interpretation - 30 kHz (76 Hz Segment)



**Table 7.8** Frequency Bar-Graph Interpretation - 40 kHz (100 Hz/Segment)



**Table 7.9** Frequency Bar-Graph Interpretation Examples

Description	Reference
<p>In this example the bar is located in the 11<sup>th</sup> segment. If the power supply is a 20 kHz unit, the stack is running in the frequency range of 19,975 Hz to 20,024 Hz.</p>	
<p>In this example the bar is located in the 7<sup>th</sup> segment. If the power supply is a 20 kHz unit, the stack is running in the frequency range of 19,775 Hz to 19,824 Hz.</p>	


## 7.6 Web Page Interface


The DCX RM B Power Supply Power Supply Web Page Interface provides access, via Ethernet connection, to power supply information, diagnostics, and configuration web pages. Communication can be established point-to-point or through a local area network.

### 7.6.1 System Requirements

To connect to the DCX Web Page Interface you will need a PC running a Windows<sup>®1</sup> operating system with a Google Chrome<sup>™2</sup> or Microsoft Edge<sup>®1</sup> web browser software.

### 7.6.2 Connecting to the Web Page Interface

NOTICE	
	<p>The DCX RM B Power Supply is not compatible with network scanning software. If your local network uses these types of programs, the DCX RM B Power Supply IP address must be placed in an exclusion list.</p>

NOTICE	
	<p>A shielded Ethernet cable should be used to connect to the DCX RM B Power Supply Web Page Interface to prevent possible EMI (Electromagnetic Interference) issues.</p>

#### 7.6.2.1 Point to Point Connection (Windows 10 or Windows 11)

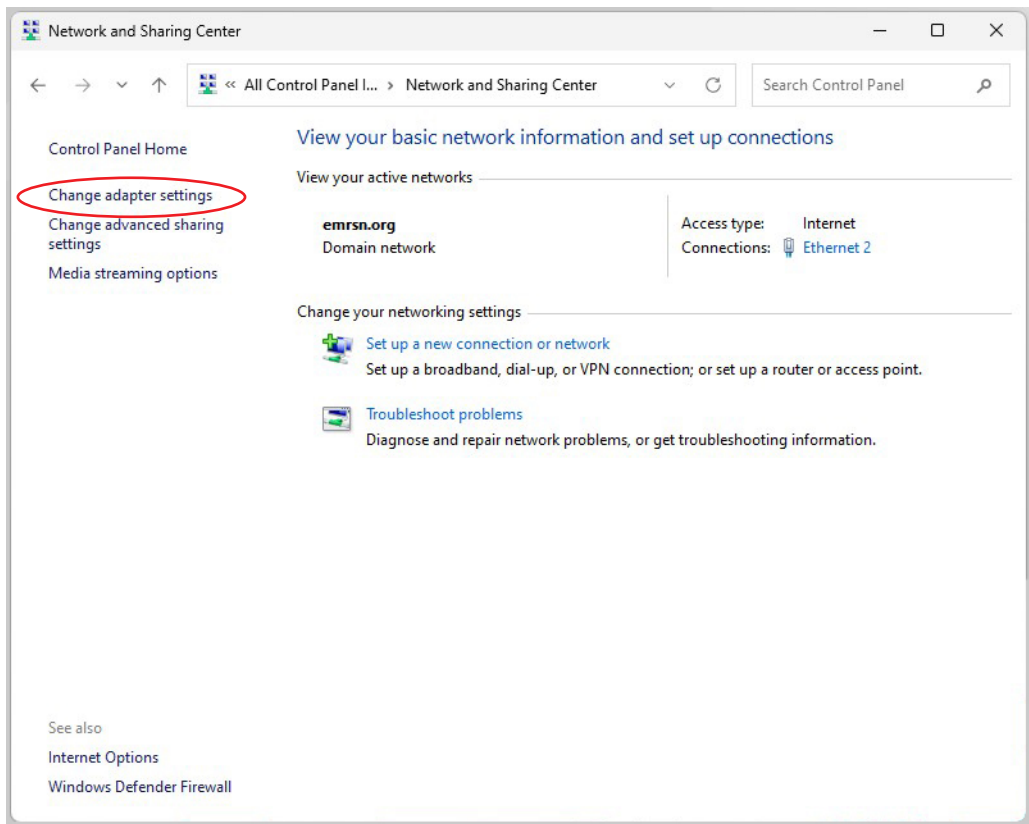
To connect directly to the DCX RM B Power Supply Web Page Interface using a PC with Windows 10<sup>®</sup> or Windows 11<sup>®</sup> operating system, complete the following steps:

1. Connect the power supply to a computer via the Ethernet port.
2. Turn on the power supply.
3. On your PC, click the Start button on the taskbar and search for the **Control Panel**.
4. Select **View Large Icons** on the top right corner.
5. Select **Network and Sharing Center**.

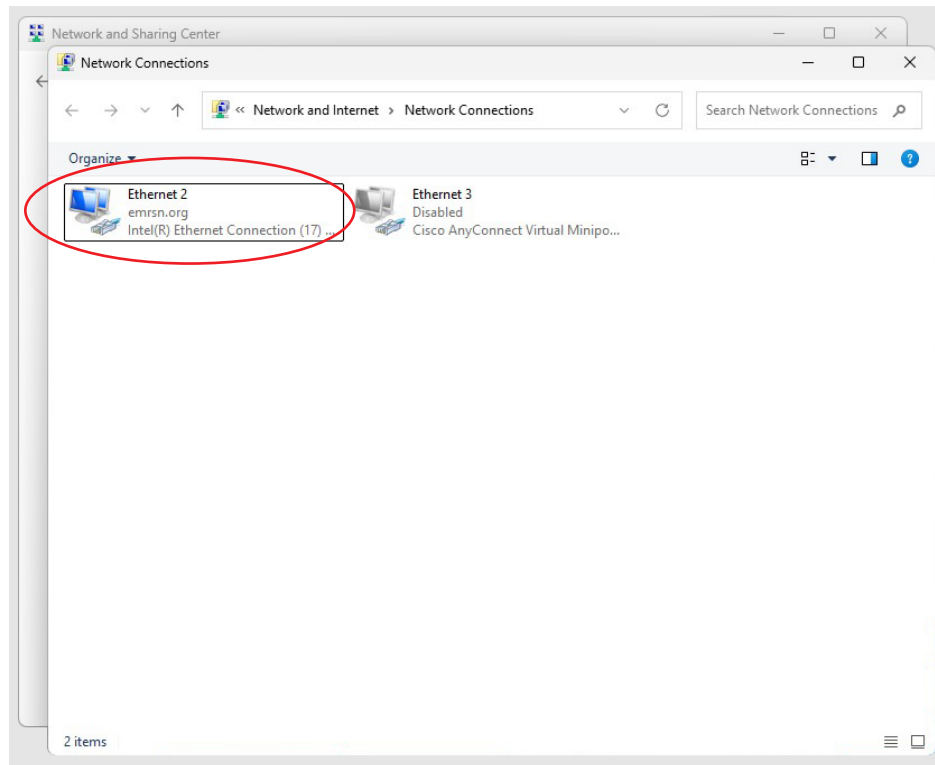
---

1. Windows 10, Windows 11, and Microsoft Edge are registered trademarks of Microsoft Corporation.  
2. Google Chrome is a trademark of Google LLC.

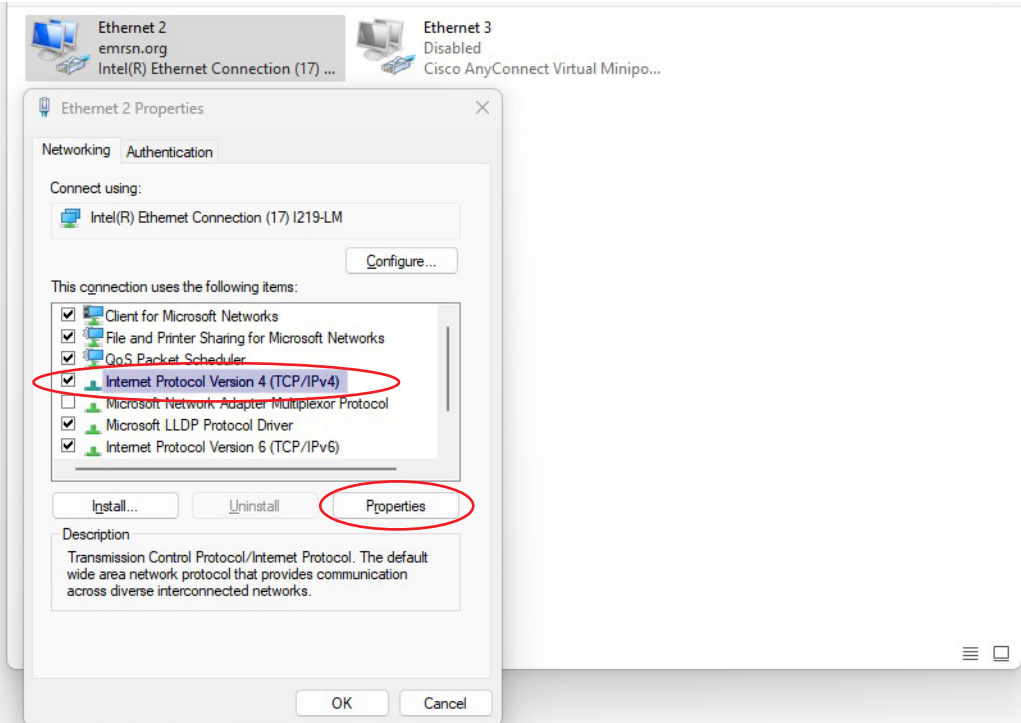
6. Select **Change adapter settings**.



7. Right click on **Ethernet 2** and select **Properties** to bring up the **Networking** tab.



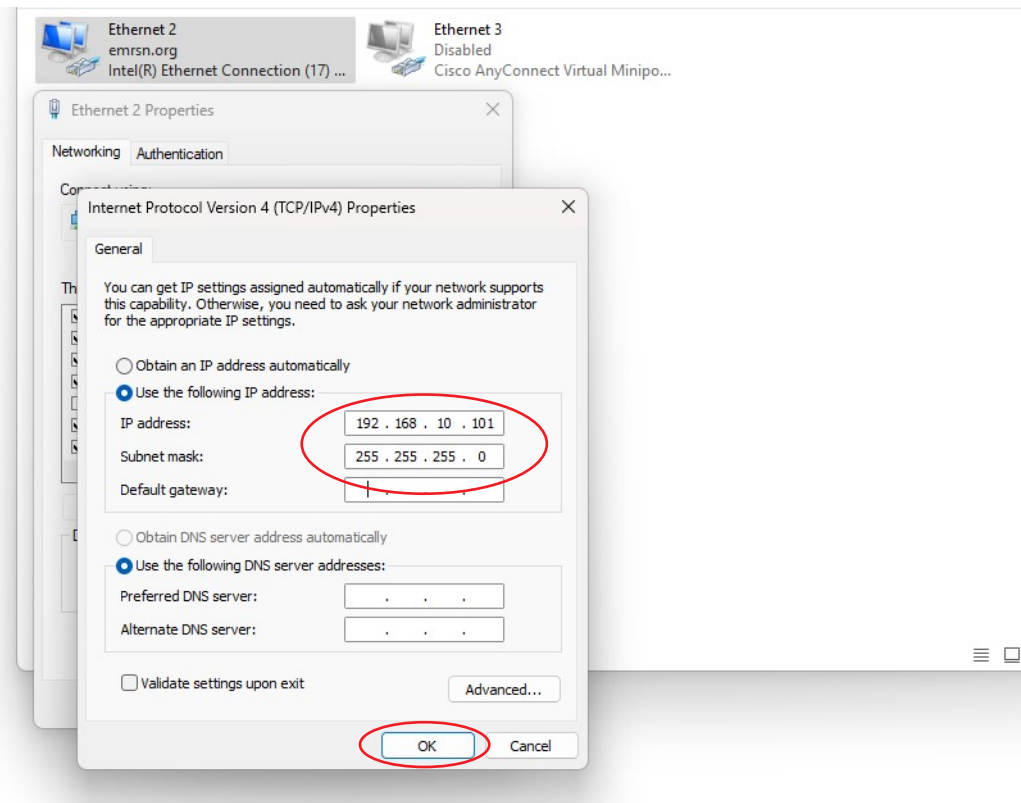
8. Highlight **Internet Protocol Version 4 (TCP/IPv4)** from the list and click on **Properties**.



9. Use the following IP address:

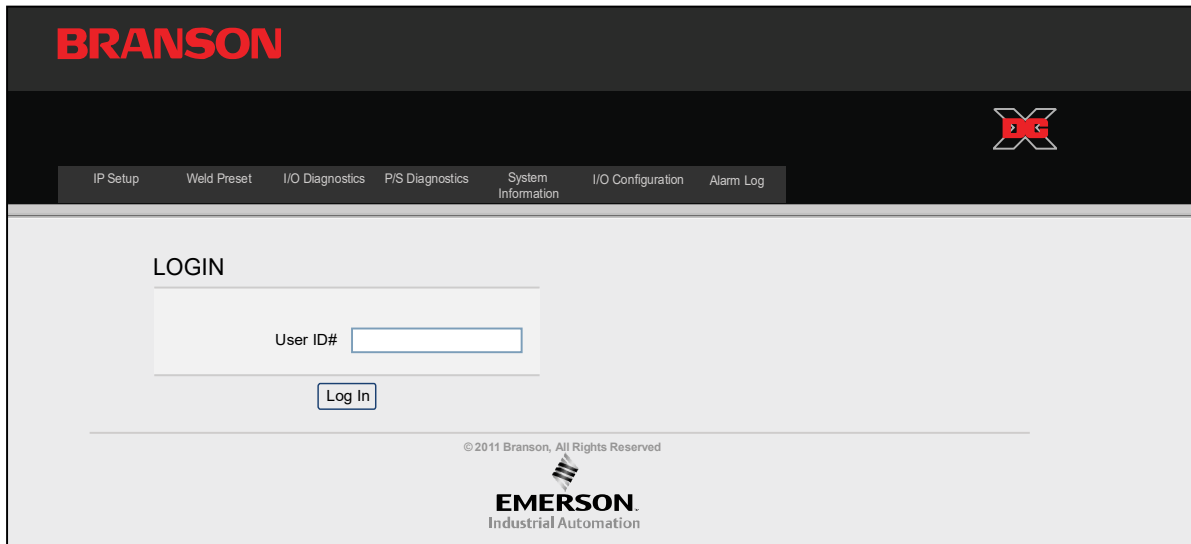
**IP address:** 192.168.10.101

**Subnet mask:** 255.255.255.0



10. Click **OK**. Close the rest of the dialog boxes.

11. Open the Chrome™ or Microsoft Edge® web browser.
12. In the address bar type the following address: <http://192.168.10.100>. Press Enter.
13. This will bring up the DCX RM B Power Supply Web Page interface.
14. Enter a user ID number (any number up to 9 digits long).





### 7.6.3 Using the Web Page Interface

For complete instructions detailing the web page interface consult the DCX Series Web Page Interface Instruction Manual.


## 7.7 Ultrasonics Test Procedure

The Ultrasonics Test function measures ultrasonic power dissipated by the ultrasonic stack with no load. The ultrasonics test procedure involves an automatic matching of the frequency of the power supply to the frequency of the converter-booster-horn stack.

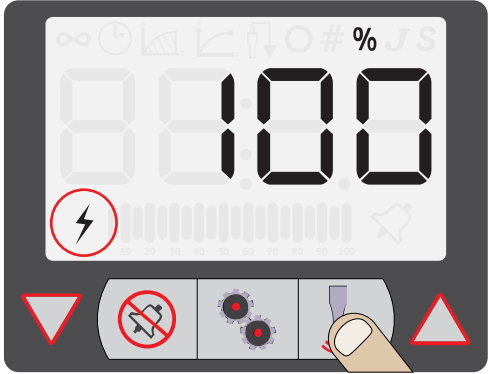
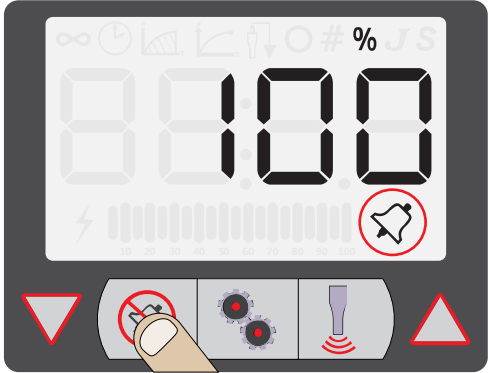
WARNING	High Voltage Hazard
	<p>Ensure that no one is in contact with the horn when testing the power supply.</p> <p>Do not cycle the welding system if either the RF cable or converter is disconnected.</p>

WARNING	High Voltage Hazard
	<p>Ensure the power supply is properly connected, as indicated in <a href="#">5.3 Installation Steps</a>.</p>

## 7.7.1 Using the Front Panel Controls

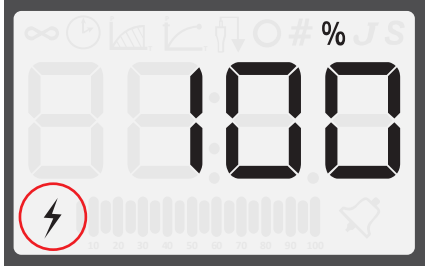
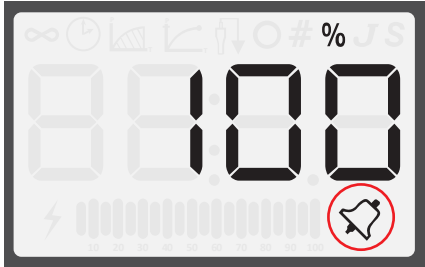
NOTICE	
	<p>To use the front panel controls, the DCX RM B Power Supply unit must be in manual mode.</p>

**Table 7.10** Power Supply Ultrasonic Test Procedure (Front Panel)

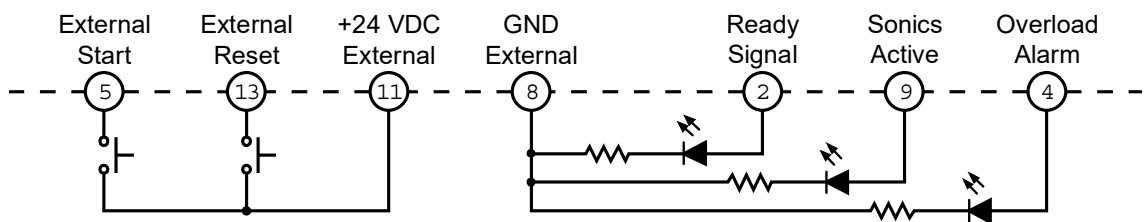
Step	Action	Reference
15	<p>Press the test key for 1-2 seconds, then release. The Sonics Active indicator appears while the test key is pressed. If the power supply alarm indicator does not appear, the test procedure is finished.</p>	
16	<p>If the alarm indicator appears, press the alarm reset key and repeat step 2 one time only. If the alarm persists, refer to <a href="#">8.5 Troubleshooting</a>.</p>	

## 7.7.2 Using the I/O Connections

**Table 7.11** Power Supply Ultrasonic Test Procedure (User I/O)

Step	Action	Reference
1	Wire the necessary I/O signals as shown on <a href="#">Figure 7.3 Test Connections.</a> , or using a similar setup.	Refer to <a href="#">Figure 7.3 Test Connections.</a> below.
2	Send an External Test signal for 1-2 seconds. The Sonics Active output will become active and the Sonics Active indicator appears while the External Start Signal is present. If the General Alarm output/ alarm indicator does not become active, the test procedure is finished.	
3	If the General Alarm output/alarm indicator becomes active, send an External Reset signal and repeat step 2 one time only. If the alarm persists, refer to <a href="#">8.5 Troubleshooting.</a>	

**Figure 7.3** Test Connections.










---

## **Chapter 8: Maintenance**

---

<b>8.1</b>	<b>General Maintenance Considerations</b> .....	<b>106</b>
<b>8.2</b>	<b>Preventive Maintenance</b> .....	<b>108</b>
<b>8.3</b>	<b>Calibration</b> .....	<b>114</b>
<b>8.4</b>	<b>Recommended Spare Stock</b> .....	<b>115</b>
<b>8.5</b>	<b>Troubleshooting</b> .....	<b>121</b>

## 8.1 General Maintenance Considerations

<b>WARNING</b>	<b>High Voltage Hazard</b>
	Power supplies produce high voltage. To avoid the possibility of an electrical shock, you should always power down your system prior to repairing any portion of it.
<b>CAUTION</b>	<b>General Warning</b>
	When performing maintenance on the welder, make sure that no other automated systems are active.
<b>NOTICE</b>	
	There are no customer replaceable components inside the power supply. Have all servicing done by a qualified Branson technician.
<b>NOTICE</b>	
	When returning printed circuit boards, make sure to enclose them in an anti-static package.
<b>NOTICE</b>	
	Connectors may not be keyed and wires may not be color-coded. Therefore, when disconnecting cables and wires, label them so you can reconnect them properly.

## NOTICE



To prevent circuit damage from electrostatic discharge, always service the power supply on a static-dissipative surface, while wearing a properly grounded wrist strap.

## NOTICE




When the battery is worn out, dispose it under the ordinance of each local government.

## 8.2 Preventive Maintenance

The following preventive measures help assure long term operation of your Branson DCX RM B Power Supply equipment.

### 8.2.1 Periodically Clean the Equipment

NOTICE	
	Use only anti-static vacuum cleaners to prevent damage from electrostatic discharge to your power supply.


Air is continuously drawn into the power supply. Periodically disconnect the unit from power, remove the cover and vacuum out any accumulated dust and debris. Remove material adhering to:

- Power supply heat sink cooling fins
- Transformers
- Circuit boards
- Cooling intake vents
- Exhaust ports

External covers may be cleaned with a damp sponge or cloth using a solution of mild soap and water. Do not allow cleaning solution to enter the unit.

To prevent rust in areas of high humidity, exposed steel surfaces, may require a very light film of rust preventing oil, such as WD-40®.

## 8.2.2 Recondition the Stack (Converter, Booster, and Horn)

NOTICE	
	<p>Never clean the converter-booster-horn stack mating surfaces by using a buffing wheel or by filing.</p>

Welding system components work most efficiently when the converter-booster-horn stack mating surfaces are flat, in solid contact, and free from fretting corrosion. Poor contact between mating surfaces wastes power output, makes tuning difficult, increases noise and heat, and may cause damage to the converter.

For standard 20 kHz and 30 kHz products, a Branson Mylar<sup>®</sup> polyester film washer should be installed between the horn and booster, and horn and converter. Replace the washer if torn or perforated. Stacks using Mylar<sup>®</sup> plastic film washers should be inspected every three months.

Stacks used with silicone grease, as with certain 20 kHz, 30 kHz and all 40 kHz products, should be periodically reconditioned to eliminate fretting corrosion. A stack using silicone grease should be inspected every two weeks for corrosion. When experience is gained for specific stacks, the inspection interval can be adjusted to a longer or shorter period as required.

### Stack Reconditioning Procedure

To recondition stack mating surfaces, take the following steps:

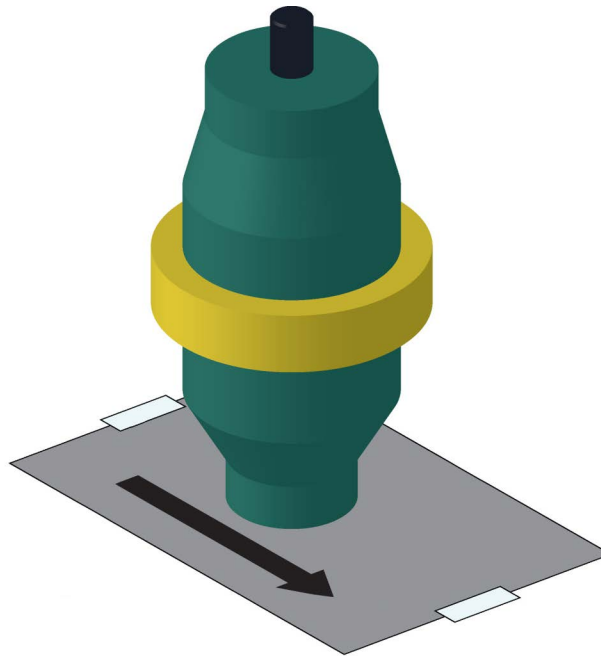
**Table 8.1** Stack Reconditioning Procedure

Step	Action
1	Disassemble the converter-booster-horn stack and wipe the mating surfaces with a clean cloth or paper towel.
2	Examine all mating surfaces. If any mating surface shows corrosion or a hard, dark deposit, recondition it.
3	If necessary, remove the threaded stud from the part.
4	Tape a clean sheet of #400 (or finer) grit emery cloth to a clean, smooth, flat surface (such as a sheet of plate glass), as in <a href="#">Figure 8.1 Reconditioning Stack Mating Surfaces</a> .
5	Place the interface surface on the emery cloth. Grasp the part at the lower end, with your thumb over the spanner-wrench hole, and lap the part in a straight line across the emery cloth. Do not apply downward pressure — the weight of the part alone provides sufficient pressure.
6	Lap the part, two or three times, in the same direction against the emery cloth. (See <a href="#">Figure 8.1 Reconditioning Stack Mating Surfaces</a> ).
7	Rotate the part 120 degrees, placing your thumb over the spanner-wrench hole, and repeat the lapping procedure in step 6.

**Table 8.1** Stack Reconditioning Procedure

Step	Action
8	Rotate the part another 120 degrees to the next spanner-wrench hole, and repeat the lapping procedure in step 6.
9	Re-examine the mating surface. If necessary, repeat steps 2-5 until you remove most of the contaminant. Remember, this should not require more than two to three complete rotations for an aluminum horn or booster; a titanium component may require more rotations.
10	<p>Before re-inserting a threaded stud in an aluminum booster or horn:                      Using a file card or wire brush, clean any aluminum bits from the knurled end of the stud.</p> <p>Using a clean cloth or towel, clean the threaded hole.</p> <p>Examine the knurled end of the stud. If worn, replace the stud. Also, examine the stud and threaded hole for stripped threads.</p> <p><b>NOTICE</b>                      Threaded studs cannot be reused in titanium horns or boosters. Replace all studs in these components.</p>
11	Assemble and install the stack.

**Figure 8.1** Reconditioning Stack Mating Surfaces



**Table 8.2** Reconditioning Stack Mating Surfaces

Item	Description
1	Tape
2	#400 Emery Cloth

### 8.2.2.1 Stack Reassembly Process

**Table 8.3** Stack Torque Values

Frequency	Torque
20 kHz	220 in·lb (24.85 N·m)
30 kHz	185 in·lb (21 N·m)
40 kHz	95 in·lb (10.73 N·m)

### For a 20 kHz System

**Table 8.4** Stack Reassembly for a 20 kHz System

Step	Action
1	Clean the mating surfaces of the converter, booster, and horn. Remove any foreign material from the threaded holes.
2	Install the threaded stud into the top of the booster. Torque to 450 in·lb (50.84 N·m). If the stud is dry, apply 1 or 2 drops of a light lubricating oil before installing.
3	Install the threaded stud into the top of the horn. Torque to 450 in·lb (50.84 N·m). If the stud is dry, apply 1 or 2 drops of a light lubricating oil before installing.
4	Install a single Mylar <sup>®</sup> plastic film washer (matching the size of the washer to the stud) to each interface.
5	Assemble the converter to the booster and the booster to the horn.
6	Torque to 220 in·lb (24.85 N·m) at each interface.

## For a 30 kHz System

**Table 8.5** Stack Reassembly for a 30 kHz System

Step	Action
1	Clean the mating surfaces of the converter, booster, and horn. Remove any foreign material from the threaded holes.
2	Install the threaded stud into the top of the booster. Torque to 290 in·lb (32.76 N·m). If the stud is dry, apply 1 or 2 drops of a light lubricating oil before installing.
3	Install the threaded stud into the top of the horn. Torque to 290 in·lb (32.76 N·m). If the stud is dry, apply 1 or 2 drops of a light lubricating oil before installing.
4	Install a single Mylar® plastic film washer (matching the size of the washer to the stud) to each interface.
5	Assemble the converter to the booster and the booster to the horn.
6	Torque to 185 in·lb (21 N·m) at each interface.

## For a 40 kHz System

**Table 8.6** Stack Reassembly for a 40 kHz System

Step	Action
1	Clean the mating surfaces of the converter, booster, and horn. Remove any foreign material from the threaded holes.
2	Apply a drop of Loctite®* 290 threadlocker (or equivalent) to the studs for the booster and horn.
3	Install the threaded stud into the top of the booster. Torque to 70 in·lb (7.91 N·m). Remove excess Loctite 290 threadlocker from the booster face and let cure for 30 minutes.
4	Install the threaded stud into the top of the horn. Torque to 70 in·lb (7.91 N·m). Remove excess Loctite 290 threadlocker from the horn face and let cure for 30 minutes.
5	Coat each interface surface with a thin film of silicon grease - but do not apply silicon grease to a threaded stud or tip.
6	Torque to 95 in·lb (10.73 N·m) at each interface.

\* Loctite is a registered trademark of Henkel Corporation, U.S.A.

### 8.2.3 Stud Torque Values

**Table 8.7** Stud Torque Values

Used on	Stud Size	Torque	EDP #
20 kHz	1/2 in x 20 x 1-1/4 in	450 in·lb, 50.84 N·m	100-098-370
	1/2 in x 20 x 1-1/2 in		100-098-123
30 kHz	3/8 in x 24 x 1 in	290 in·lb, 32.76 N·m	100-298-170R
40 kHz*	M8X1.25 X 20	70 in·lb, 7.91 N·m	100-098-790

\* Add a drop of Loctite 290 threadlocker to the stud. Torque and let cure for 30 minutes before using.

### 8.2.4 Routine Component Replacement

The lifetime of certain parts is based on the number of cycles the unit has completed, or on hours of operation.

## 8.3 Calibration

This product does not normally require scheduled calibration. However, if you are operating under any type of regulatory requirements, you may need to calibrate the equipment according to that schedule and set of standards. Contact Branson for details.

## 8.4 Recommended Spare Stock

This section provides lists of replacement parts, system cables, and suggested spares.

### 8.4.1 System Cables

You can order the following cables:

**Table 8.8** DCX RM B Power Supply System Cables

P/N	Description
100-240-383	Cable, RF 8 ft (2.5 m)
100-240-384	Cable, RF 15 ft (4.5 m)
100-240-385	Cable, RF 25 ft (7.5 m)
100-240-387	Cable, RF right angle 8 ft (2.5 m)
100-240-388	Cable, RF right angle 15 ft (4.5 m)
100-240-389	Cable, RF right angle 25 ft (7.5 m)
011-003-515	Cable, JDC 3 control
200-240-396	Cable Ethernet Cat 5e 7 ft (2.1 m)

## 8.4.2 Suggested Spares

**Table 8.9** Suggested Spares

Description	EDP#	1-4 Units	6-12 Units	14+ Units
Converter	Refer to <a href="#">Table 8.10 Converters Compatible with the DCX RM B Power Supply.</a>	0	1	2
Booster	Refer to <a href="#">Table 8.11 DCX RM B Power Supply Compatible Boosters.</a>	0	1	2
Horn	As Ordered	1	1	2
Studs	Refer to <a href="#">Table 8.12 Other Items used with the DCX RM B Power Supply.</a>	4	6	8
Mylar <sup>®</sup> Plastic Film Washer Kit	Refer to <a href="#">Table 8.12 Other Items used with the DCX RM B Power Supply.</a>	1	1	1

### 8.4.3 Converters Compatible with the DCX RM B Power Supply

**Table 8.10** Converters Compatible with the DCX RM B Power Supply

Where used	Model	Connector	Part Number
20 kHz / 4000 W	CR-20S	SHV connector	125-135-115R
	CR-20C	SHV connector with 3 ft (0.9 m) cable	159-135-210R
	CH-20S (932 AH SPL)	SHV connector	159-135-075R
	CH-20C	SHV connector with 3 ft (0.9 m) cable	159-135-211R
	CS-20S	SHV connector	159-135-138R
	CS-20C	SHV connector with 3 ft (0.9 m) cable	159-135-209R
20 kHz / 1100 W	902	902R converter	101-135-048R
30 kHz / 1500 W	CR-30S	SHV connectors	101-135-081R
	CR-30C	SHV connector with 3 ft (0.9 m) cable	159-135-213R
	CH-30S	SHV connector	101-135-071R
	CH-30C	SHV connector with 3 ft (0.9 m) cable	159-135-214R
	CS-30S	SHV connector	159-135-110R
	CS-30C	SHV connector with 3 ft (0.9 m) cable	159-135-212R
40 kHz / 800 W	4TP	SHV connector (platen mount)	101-135-068R
	CR-40S (4TH)	SHV connector	101-135-067R
	CR-40C	SHV connector with 3 ft (0.9 m) cable	159-135-215R

## 8.4.4 DCX RM B Power Supply Compatible Boosters

**Table 8.11** DCX RM B Power Supply Compatible Boosters

Type of Booster	Description	Part Number
Solid Mount (1/2-20 horn stud) 20 kHz	Titanium, 1:0.6 (Purple)	101-149-095
	Titanium, 1:1 (Green)	101-149-096
	Titanium, 1:1.5 (Gold)	101-149-097
	Titanium, 1:2 (Silver)	101-149-098
	Titanium, 1:2.5 (Black)	101-149-099
Solid Mount (M8 x 1.25 horn stud) 40 kHz	Titanium, 1:0.6 (Purple)	109-041-178
	Titanium, 1:1 (Green)	109-041-177
	Titanium, 1:1.5 (Gold)	109-041-176
	Titanium, 1:2 (Silver)	109-041-175
	Titanium, 1:2.5 (Black)	109-041-174
Standard Series (1/2-20 horn stud) 20 kHz	Aluminum, 1:0.6 (Purple)	101-149-055
	Aluminum, 1:1 (Green)	101-149-051
	Aluminum, 1:1.5 (Gold)	101-149-052
	Aluminum, 1:2 (Silver)	101-149-053
	Titanium, 1:0.6 (Purple)	101-149-060
	Titanium, 1:1 (Green)	101-149-056
	Titanium, 1:1.5 (Gold)	101-149-057
	Titanium, 1:2 (Silver)	101-149-058
Standard Series (3/8-24 horn stud) 30 kHz	Titanium, 1:2.5 (Black)	101-149-103
	Titanium, 1:2 (Silver)	101-149-104
	Titanium, 1:1.5 (Gold)	101-149-105
	Titanium, 1:1 (Green)	101-149-106

**Table 8.11** DCX RM B Power Supply Compatible Boosters

Type of Booster	Description	Part Number
Standard Series (M8 x 1.25 horn stud) 40 kHz	Aluminum, 1:0.6 (Purple)	101-149-087
	Aluminum, 1:1 (Green)	101-149-079
	Aluminum, 1:1.5 (Gold)	101-149-080
	Aluminum, 1:2 (Silver)	101-149-081R
	Aluminum, 1:2.5 (Black)	101-149-082
	Titanium, 1:1 (Green)	101-149-085
	Titanium, 1:1.5 (Gold)	101-149-086
	Titanium, 1:2 (Silver)	101-149-083
	Titanium, 1:2.5 (Black)	101-149-084

## 8.4.5 Other Items used with the DCX RM B Power Supply

**Table 8.12** Other Items used with the DCX RM B Power Supply


Product	Description	Part No.
Silicone grease	For use with 40 kHz systems	101-053-002
Mylar® Plastic Film Washers (for 20 kHz systems)	Kit, 10 each (1/2 in and 3/8 in)	100-063-357
	Kit, 150 each (1/2 in)	100-063-471
	Kit, 150 each (3/8 in)	100-063-472
Mylar® Plastic Film Washers (for 30 kHz systems)	Kit, 10 each (3/8 in)	100-063-632
	Kit, 150 each (3/8 in)	100-063-712
Tool Kit	20 kHz (spanner wrench and 10 pc washer kit)	101-063-208R
	30 kHz (spanner wrench and 10 pc washer kit)	101-063-636R
	40 kHz (spanner wrench and silicone grease)	101-063-176R
Spanner wrench	20 kHz	101-118-039
	30 kHz	201-118-033
	40 kHz	201-118-024
Studs	1/2-20 x 1-1/4 (titanium horns)	100-098-370
	1/2-20 x 1-1/2 (aluminum horns, 20 kHz boosters)	100-098-123
	3/8-24 x 1 (30 kHz titanium horns and boosters)	100-298-170R
	M8X1.25 X 20 (40 kHz horns and boosters)	100-098-790

## 8.5 Troubleshooting


If you have a problem operating the DCX RM B Power Supply, take the following steps:

**Table 8.13** Troubleshooting

Step	Action
1	Make sure the converter-booster-horn stack is properly assembled and installed.
2	For instructions on reconditioning stack component surfaces, refer to <a href="#">8.2.2 Recondition the Stack (Converter, Booster, and Horn)</a>
3	If you need additional help, call your local Branson representative, refer to <a href="#">1.3 How to Contact Branson</a> .

NOTICE	
	DCX RM B Power Supply should be serviced only by qualified technicians using Branson-approved test and repair equipment, repair procedures, and replacement parts. Unauthorized attempts at repair or modification of the power supply will void the warranty.

## 8.5.1 Common Electrical Problems

NOTICE	
	<p>If the circuit breaker fails more than once, this usually indicates that another component has failed. Continue troubleshooting other components.</p>

**Table 8.14** Troubleshooting Common Electrical Problems

Problem	Check	Solution
Main circuit breaker trips when plugging the power supply into an electrical outlet.	Inspect line connection cables.	If failed, replace.
Main circuit breaker trips during weld cycle.	Check current rating of the main circuit breaker.	If failed, replace.
Main circuit breaker fails during power up.	Check main circuit breaker current rating.	If incompatible, replace main circuit breaker.
When touching a component of the weld system, you get a slight electrical shock.	Ensure the Ground cable is connected properly.	N/A
	Inspect the line cables.	If failed, repair or replace.

## 8.5.2 Ultrasonic Power Problems

**Table 8.15** Troubleshooting Ultrasonic Power Problems

Problem	Check	Solution
Ultrasonic power delivered to horn; no indication on bar graph.	Check connector cables, replace if failed.	Replace defective cables.
	Test power supply.	See <a href="#">Chapter 7: Operation 7.7 Ultrasonics Test Procedure</a> .
No ultrasonic power generated when Test key pressed; no Alarm indicator.	Failed or missing stack.	Replace.
	RF cable unplugged or failed; replace if failed.	Plug in or replace.
	Test power supply ( <a href="#">Chapter 7: Operation 7.7 Ultrasonics Test Procedure</a> ).	If defective, send unit for repair.
Unable to adjust amplitude using the front panel keypad.	Register setting configured to "External Amplitude Control".	Reset if required, See <a href="#">Chapter 7: Operation 7.4 Configuring the Power Supply Registers</a> .
Unable to remote control.	User I/O cable.	Repair or replace.
	Customer's switching device.	Test/inspect/repair/replace.

## 8.5.3 Weld Cycle Problems

**Table 8.16** Troubleshooting Weld Cycle Problems

Problem	Check	Solution
Full ultrasonic power not delivered.	Unsuitable horn or booster selection.	Contact Branson Applications Lab
	Plastic part material varies.	
	Mold release lubricant in weld area.	
	Unsuitable joint design.	
	Unsuitable or misaligned part fixture.	
	Amplitude setting.	Adjust if required.
No ultrasonic power passed to horn.	Power supply overheating.	Remove dust and debris.
Alarm indicator illuminates when you press the Test key or during the weld cycle.	Check converter-booster-horn stack interface for fretting corrosion.	See <a href="#">8.2.2 Recondition the Stack (Converter, Booster, and Horn)</a> .
	Check for loose or failed horn converter or booster.	Tighten or replace as needed.
	Check for loose or failed horn or booster stud.	
	Failed RF cable.	Replace if failed.
Excessively warm horn, booster, and converter; occasional overloads.	Check converter-booster-horn stack mating surfaces for fretting corrosion.	See <a href="#">8.2.2 Recondition the Stack (Converter, Booster, and Horn)</a> .
	Be certain proper cooling has been provided.	See <a href="#">5.2.1 Installing the DCX RM B Power Supply Drawers in a Customer Rack</a> .

---

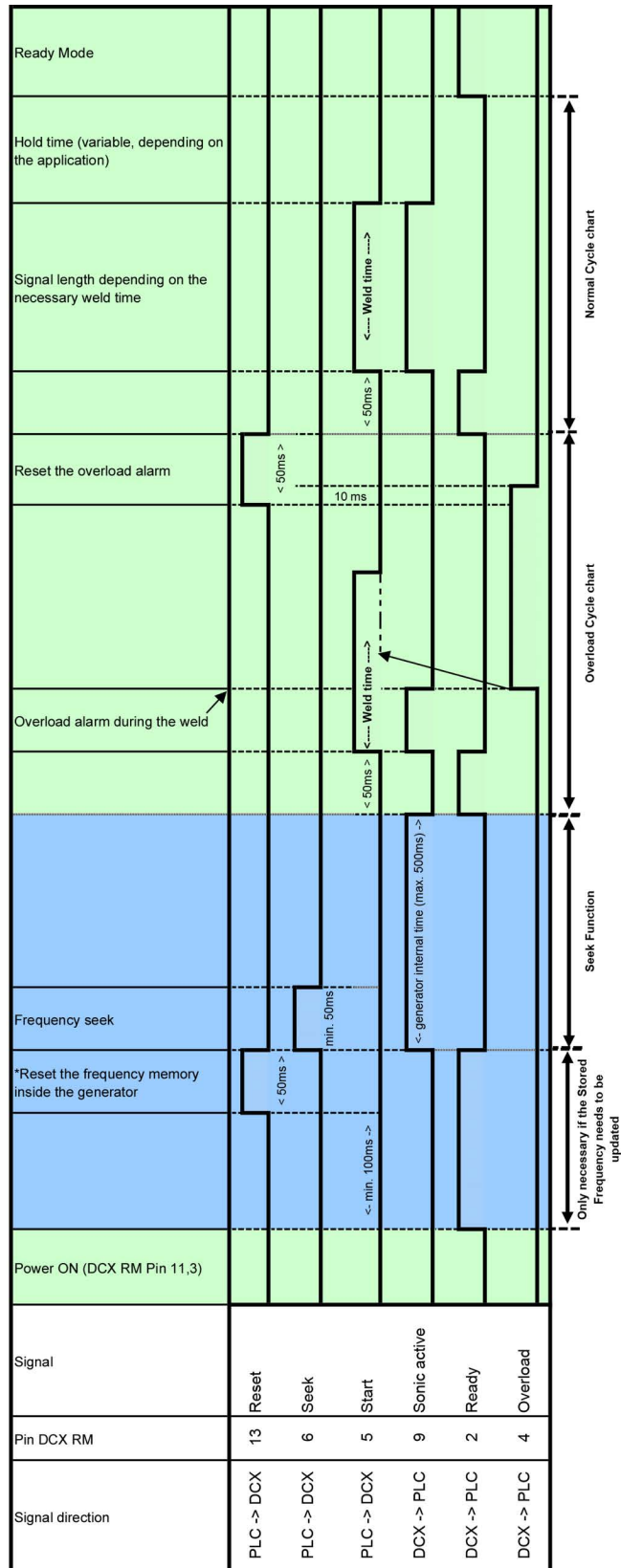
# **Appendix A: Signal Diagrams**

---

**A.1 Signal Diagrams ..... 126**

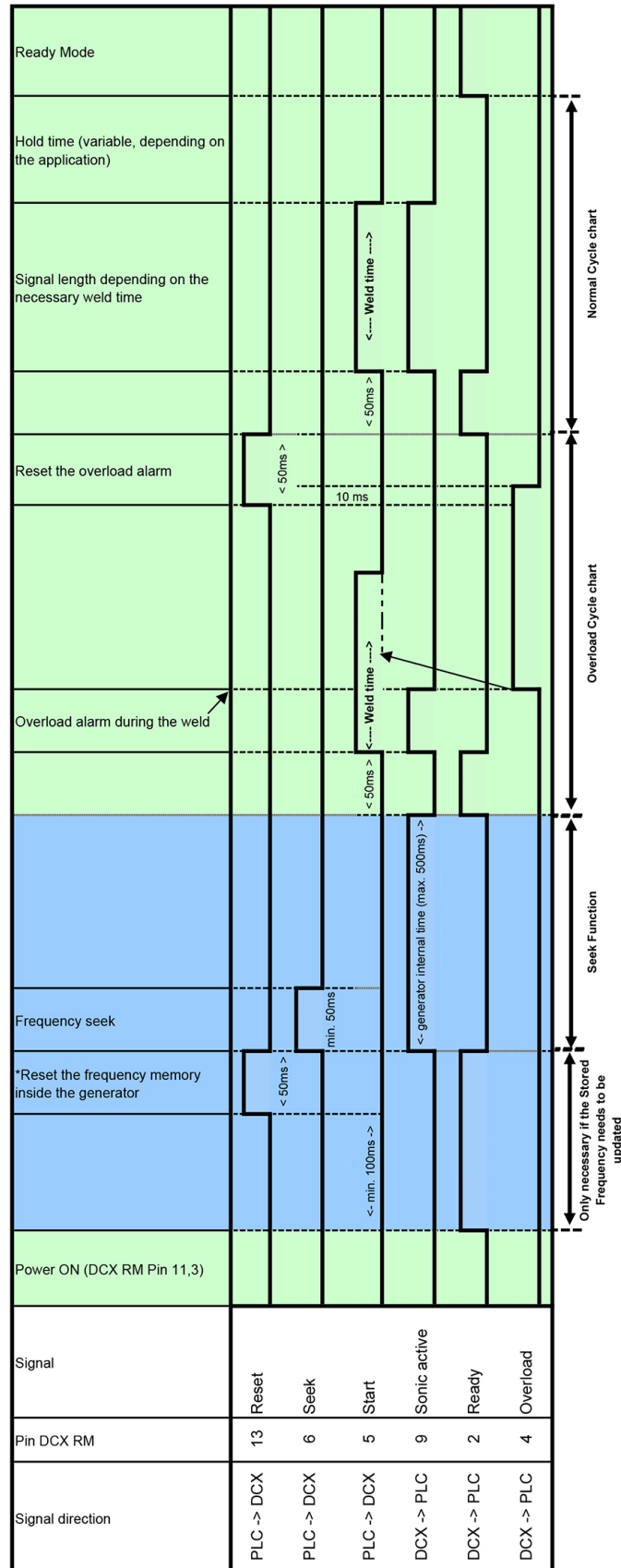
## A.1 Signal Diagrams

Figure A.1 Continuous



\*Register #144 must be set to 1.

**Figure A.2** Continuous, Overload Error



\*Register #144 must be set to 1.



---

## **Appendix B: Manual's Revisions**

---

**B.1 Manual's Revisions ..... 130**

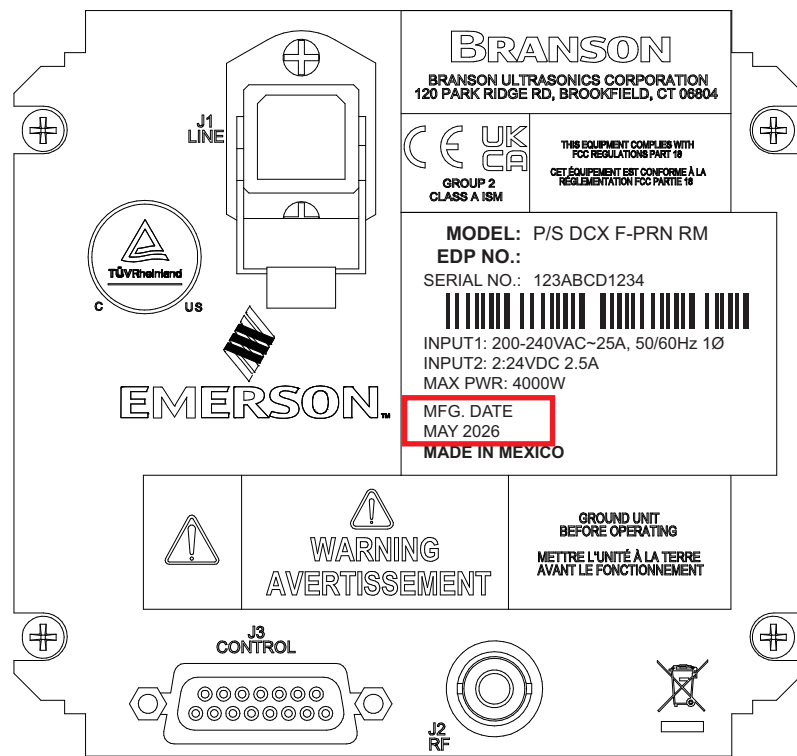
## B.1 Manual's Revisions

Refer to the table below for the appropriate manual revision depending on your Power Supply's manufacturing date.

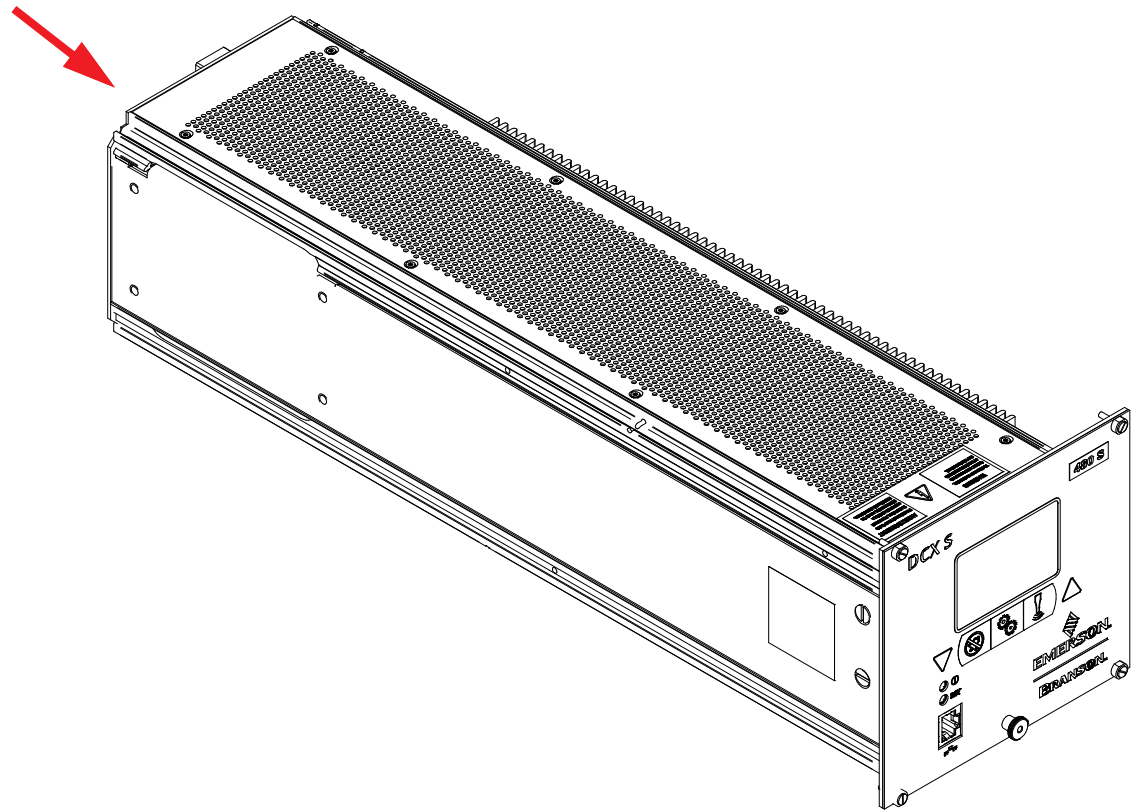
**Table B.1** Manual's Revisions

Manual's Revisions	Power Supply's Manufacturing Date	
	From	To
00	April 2022	March 2026
01	April 2026	To date

**Figure B.1** Manufacturing date on the Information label



**Figure B.2** Location of the Information label on the back of the DCX RM B Power Supply





---

# Index

---

## A

- about Installation 44
- Actuator 28
- Alarm 28
- alarm
  - configuring 63
  - latching 63
  - modes 63
- Amplitude 28
- amplitude
  - controlling 63
  - start ramp 63
- Amplitude Control 28
- amplitude control 63
- applications 27
- autotune with memory (AT/M) 17
- Autotuning 19

## B

- bar graph 94
  - frequency interpretation 95
  - power interpretation 94
- bend radius 50
- Booster 28
- booster 21
  - dimensions 40, 74
  - part numbers 118

## C

- cables
  - bend radius 50
  - RF 61
  - user I/O 53
- Clamping Force 28
- Cold Start 28
- cold start 124
- components
  - functional description 83
- connecting tip to horn 68
- connection
  - input power 63
  - user I/O 53
- connector
  - line 26
  - RF 26
  - user I/O 26
- controls, front panel 22
- Converter 28

- converter 21, 83
  - cooling 69
  - dimensions 40, 74
  - part numbers 117
- Counters 28

## D

- Degating 28
- Digital Amplitude Setting 19
- drop test 32

## E

- electrical input
  - operating voltages 38
- Energy Director 28
- environmental
  - requirements 49
  - specifications 32
- External Amplitude Control 28
- External Frequency Control 28

## F

- Fixture 28
- Flash 28
- Forming 28
- Frequency 28
- frequency
  - end of weld store 63
  - offset 17
- Frequency Offset 19, 29
- frequency offset
  - setup 63
- Fretting Corrosion 28

## G

- Gain 29

## H

- Horn 29
- horn 21
- Horn Amplitude 29
- Horn Signature 19, 29
- humidity 32, 38, 49

## I

- indicators 22
- input power 61, 62
  - plug 63
  - ratings 39, 49
- inputs
  - analog 58
- Insertion 29
- installation 43
  - requirements 45
  - stack 71

- steps 50
- testing 71
- Interface 29
- inventory of small parts 35

## **J**

- Joint 29

## **L**

- LCD 19
  - bar graph 94
    - frequency interpretation 95
    - power interpretation 94
  - description 24
  - viewing angle 51
- line input
  - connector 26
- Line Regulation 19
- line regulation 17
- Load Regulation 19
- load regulation 17

## **M**

- maintenance 105
  - general considerations 106
- manual set 17
- Membrane Keys 19

## **O**

- operating voltages 38
- operation 85
  - principle of 27
- output power cable 61
- outputs
  - analog 59
  - digital 58

## **P**

- Parameter 29
- Parameter Range 29
- parts lists 115
- Passcodes 19
- periodic and preventive maintenance
  - periodically clean the equipment 108
  - recondition the stack 109
  - routine component replacement 115
- Power Supply 29
- power supply
  - configuring 89, 90
  - connections 26
  - continuous duty max. power 39
  - cycle rate 40
  - default settings (cold start) 124
  - front panel controls 22
  - manual set 17

models 16, 17  
mounting 51

## R

Ramp Starting 19  
receiving the equipment 33  
returning equipment 36

## S

safety  
  general precautions 6  
  maintenance 106  
  symbols, meaning 2  
Seek 20, 29  
seek  
  ramp time 63  
  time 63  
  timed 17, 63  
shipping and handling 32  
shock 32  
solid mount boosters 84  
special cable requirements 51  
stack 21, 83  
stack assembly 64  
  20 kHz 67, 111, 112  
  30 kHz 67  
  40 kHz 67  
Staking 29  
Start-up Diagnostics 20  
support 72  
Swaging 29  
System Protection 20  
system requirements, web page interface 97

## T

technical specifications 37  
temperature  
  ambient operating temperature 38, 49  
  shipping and storage 32, 38  
Thermoplastic 29  
Thermoset 29  
Timed Seek 20  
timed seek 17  
Token 29  
troubleshooting  
  electrical problems 122  
  ultrasonic power 123  
  weld cycle problems 124  
True Wattmeter 20

## U

Ultrasonic Power 29  
ultrasonic stack 83  
Ultrasonic Welding 29  
unpacking 34

User ID 19, 29

## **V**

vibration 32

## **W**

Web Page Interface 20

web page interface 17, 101

point-to-point connection

Windows 10 or Windows 11 97

Weld System 29

weld system

applications 27

welding systems 27

