



**EMERSON**<sup>TM</sup>

Original Instructions  
4000856 - REV. 01

IP Setup Weld Preset IO Diagnostics Seek & Weld Graphs Horn Signature System Information I/O Configuration Alarm Log

**WELD**

**Amplitude**

Weld Amplitude (%)

Amplitude Ramp (ms)

External

**Frequency**

Digital Tune (Hz)

Internal Offset (Hz)

External Offset

End of Weld Store

Clear memory with Reset

Clear memory before Seek

Set with Horn Scan

**SEEK**

Seek Ramp (ms)

Seek Time (ms)

Frequency Offset (Hz)

Timed Seek

**POWER ON**

Off

Seek

Scan

Clear Memory

**MISC SETUP**

Alarms - Reset Required

# DCX RM B Web Page

# Operating Manual

**Branson Ultrasonics Corp.**  
120 Park Ridge Road  
Brookfield, CT 06804  
(203) 796-0400  
<http://www.bransonultrasonics.com>

**BRANSON**

## Manual Change Information

At Branson, we strive to maintain our position as the leader in ultrasonics plastics joining, metal welding, cleaning and related technologies by continually improving our circuits and components in our equipment. These improvements are incorporated as soon as they are developed and thoroughly tested.

Information concerning any improvements will be added to the appropriate technical documentation at its next revision and printing. Therefore, when requesting service assistance for specific units, note the Revision information found on this document, and refer to the printing date which appears on this page.

## Copyright and Trademark Notice

Copyright © 2026 Branson Ultrasonics Corporation. All rights reserved. Contents of this publication may not be reproduced in any form without the written permission of Branson Ultrasonics Corporation.

Mylar is a registered trademark of DuPont Teijin Films.

Loctite is a registered trademark of Loctite Corporation.

WD-40 is a registered trademark of WD-40 Company.

Windows 10, Windows 11, and Microsoft Edge are registered trademarks of Microsoft Corporation.

Google Chrome is a trademark of Google LLC.

Other trademarks and service marks mentioned herein are held by their respective owners.

## Foreword

Congratulations on your choice of a Branson Ultrasonics Corporation system!

The Branson DCX RM B Power Supply system is process equipment for the joining of plastic parts using ultrasonic energy. It is the newest generation of product using this sophisticated technology for a variety of customer applications. This Operating Manual is part of the documentation set for this system, and should be kept with the equipment.

Thank you for choosing Branson!

## Introduction

This manual is arranged into several structured chapters which will help you find the information you may need to know to safely handle, install, set up, program, operate, and/or maintain this product. Please refer to the [Table of Contents](#) and/or the [Index](#) of this manual to find the information you may be looking for. In the event you require additional assistance or information, please contact our Product Support department (see [1.3 How to Contact Branson](#) for information on how to contact them) or your local Branson representative.



---

# Table of Contents

---

## Chapter 1: Safety and Support

1.1 Safety Requirements and Warnings . . . . .	2
1.2 General Precautions . . . . .	4
1.3 How to Contact Branson . . . . .	6

## Chapter 2: The Web Page Interface

2.1 Introduction. . . . .	8
2.2 Models Covered . . . . .	9

## Chapter 3: Connecting to the Web Page Interface

3.1 Locating the Ethernet Port. . . . .	12
3.2 System Requirements. . . . .	13
3.3 Point to Point Connection (Windows Vista and Windows 7) . . . . .	14

## Chapter 4: The Web Page Interface

4.1 Web Page Interface Overview . . . . .	18
4.2 Login . . . . .	19
4.3 IP Setup . . . . .	20
4.4 Weld Preset. . . . .	22
4.5 I/O Diagnostics . . . . .	24
4.6 Seek & Weld Graphs. . . . .	25
4.7 Horn Signature . . . . .	27
4.8 System Information . . . . .	29
4.9 Alarm Log . . . . .	30

## Appendix A: Manual's Revisions

A.1 Manual's Revisions . . . . .	34
----------------------------------	----



---

# List of Figures

---

## Chapter 1: Safety and Support

## Chapter 2: The Web Page Interface

## Chapter 3: Connecting to the Web Page Interface

Figure 3.1 DCX RM B Power Supply. . . . .12

## Chapter 4: The Web Page Interface

Figure 4.1 Web Page Interface Overview . . . . .18

Figure 4.2 Login . . . . .19

Figure 4.3 IP Setup Menu . . . . .20

Figure 4.4 Weld Preset Menu . . . . .22

Figure 4.5 I/O Diagnostics Menu. . . . .24

Figure 4.6 Seek & Weld Graphs Menu . . . . .25

Figure 4.7 Horn Signature Menu. . . . .27

Figure 4.8 System Information Menu . . . . .29

Figure 4.9 Alarm Log Menu . . . . .30

## Appendix A: Manual's Revisions

Figure A.1 Manufacturing date on the Information label. . . . .34

Figure A.2 Location of the Information label on the back of the DCX RM B Power Supply. . . . .35



---

# List of Tables

---

## Chapter 1: Safety and Support

## Chapter 2: The Web Page Interface

## Chapter 3: Connecting to the Web Page Interface

## Chapter 4: The Web Page Interface

Table 4.1	Web Page Interface Overview . . . . .	18
Table 4.2	IP Setup Menu Option . . . . .	20
Table 4.3	Weld Preset Menu Option . . . . .	22
Table 4.4	I/O Diagnostics Menu Option . . . . .	24
Table 4.5	Seek & Weld Graphs Menu Option . . . . .	26
Table 4.6	Horn Signature Menu Option . . . . .	28
Table 4.7	System Information Menu Option . . . . .	29
Table 4.8	Alarm Log Menu Option . . . . .	30

## Appendix A: Manual's Revisions

Table A.1	Manual's Revisions . . . . .	34
-----------	------------------------------	----



---

# **Chapter 1: Safety and Support**

---





**1.1 Safety Requirements and Warnings . . . . . 2**  
**1.2 General Precautions . . . . . 4**  
**1.3 How to Contact Branson . . . . . 6**



## 1.1 Safety Requirements and Warnings

This chapter contains an explanation of the different safety notice symbols and icons found in this manual and provides additional safety information for ultrasonic welding. This chapter also describes how to contact Branson for assistance.

### 1.1.1 Symbols Found in this Manual

These symbols used throughout this manual warrant special attention:

<b>WARNING</b>	<b>Indicates a possible danger</b>
	If these risks are not avoided, death or severe injury might result.
<b>WARNING</b>	<b>High Voltage Hazard</b>
	High voltage. Turn power off before servicing.
<b>WARNING</b>	<b>Corrosive Material Hazard</b>
	Corrosive material. Avoid contact with eyes and skin. Wear proper protection.
<b>CAUTION</b>	<b>Indicates a possible danger</b>
	If these risks are not avoided, slight or minor injury might result.

<b>CAUTION</b>	<b>Loud Noise Hazard</b>
	Loud noise hazard. Ear protection must be worn.
<b>CAUTION</b>	<b>Heavy Object</b>
	Heavy object. To avoid muscle strain or back injury, use lifting aids and proper lifting techniques.
<b>NOTICE</b>	<b>Indicates a possible damaging situation</b>
	If this situation is not avoided, the system or something in its vicinity might get damaged. Application types and other important or useful information are emphasized.

## 1.2 General Precautions

Take the following precautions before servicing the power supply:

- Be sure the power is disconnected before making any electrical connections
- To prevent the possibility of an electrical shock, always plug the power supply into a grounded power source
- Power supplies produce high voltage. Before working on the power supply assembly, do the following:
  - Turn off the power supply
  - Unplug main power
  - Allow at least 5 minutes for capacitors to discharge
- High voltage is present in the power supply. Do not operate with the cover removed
- High line voltages exist in the ultrasonic power supply assembly. Common points are tied to circuit reference, not chassis ground. Therefore, use only non-grounded, battery-powered multimeters when testing the power supply assembly. Using other types of test equipment can present a shock hazard
- Keep hands from under the horn. Down force (pressure) and ultrasonic vibrations can cause injury
- Do not cycle the welding system if either the RF cable or converter is disconnected
- When using larger horns, avoid situations where fingers could be pinched between the horn and the fixture

CAUTION	Loud Noise Hazard
	<p>Sound level and frequency of the noise emitted during the ultrasonic assembly process may depend upon <b>a.</b> type of application, <b>b.</b> size, shape and composition of the material being assembled, <b>c.</b> shape and material of the holding fixture, <b>d.</b> welder setup parameters and <b>e.</b> tool design.</p> <p>Some parts vibrate at an audible frequency during the process. Some or all of these factors may result in an uncomfortable noise being emitted during the process.</p> <p>In such cases operators may need to be provided with personal protective equipment. See 29 CFR (Code of Federal Regulations) 1910.95 Occupational Noise Exposure.</p>

NOTICE	
	<p>When the battery is worn out, dispose it under the ordinance of each local government.</p>

WARNING	Corrosive Material Hazard
	<p>First aid measures (in case of electrolyte leakage from the battery)</p> <p><b>Eye Contact:</b> Flush the eyes with plenty of clean water for at least 15 minutes immediately, without rubbing. Get immediate medical treatment. If appropriate procedures are not taken, this may cause eye injury.</p> <p><b>Skin Contact:</b> Wash the affected area under tepid running water using a mild soap. If appropriate procedures are not taken, this may cause sores on the skin. Get medical attention if irritation develops or persists.</p> <p><b>Inhalation:</b> Remove to fresh air immediately. Get medical treatment immediately.</p>

### 1.2.1 Intended Use of the System

The DCX Power Supply and components are designed to be used as part of an ultrasonic welding system. These are designed for a wide variety of welding or processing applications.

The system can be used to perform ultrasonic welding, inserting, staking, spot welding, swaging, degating, and continuous ultrasonic operations. It is designed for automated, semi-automated and/or manual production operations.

### 1.2.2 Emissions

When being processed, certain plastic materials can emit toxic fumes, gases or other emissions that can be hazardous to the operator's health. Where such materials are processed, proper ventilation of the workstation is required. Check your materials suppliers for recommended protection when processing their materials.

WARNING	Corrosive Material Hazard
	<p>Processing of many materials, such as PVC, can be hazardous to an operator's health and could cause corrosion/damage to the equipment. Use proper ventilation and take protective measures.</p>

## **1.3 How to Contact Branson**

For additional assistance, please refer to the DCX RM B Power Supply Instruction Manual.

---

## **Chapter 2: The Web Page Interface**

---

<b>2.1</b>	<b>Introduction . . . . .</b>	<b>8</b>
<b>2.2</b>	<b>Models Covered . . . . .</b>	<b>9</b>

## 2.1 Introduction

The DCX RM B Web Page Interface provides access, via Ethernet connection, to web pages containing power supply information, diagnostics tools, and configuration options. Communication can be established point-to-point or through a local area network. On the web page interface you can access:

- [4.3 IP Setup](#)
- [4.4 Weld Preset](#)
- [4.5 I/O Diagnostics](#)
- [4.6 Seek & Weld Graphs](#)
- [4.7 Horn Signature](#)
- [4.8 System Information](#)
- [4.9 Alarm Log](#)

## **2.2 Models Covered**

This manual applies to the web page interface of the DCX RM B power supply.

### **2.2.1 DCX RM B Power Supply Manual Set**

The following documentation is available in electronic format for the DCX RM B power supply:

- DCX RM B Power Supply Instruction Manual



---

## **Chapter 3: Connecting to the Web Page Interface**

---

<b>3.1</b>	<b>Locating the Ethernet Port . . . . .</b>	<b>12</b>
<b>3.2</b>	<b>System Requirements . . . . .</b>	<b>13</b>
<b>3.3</b>	<b>Point to Point Connection (Windows 10 or Windows 11) . . . . .</b>	<b>14</b>

## 3.1 Locating the Ethernet Port

### 3.1.1 DCX RM B Ethernet Port Location

Figure 3.1 DCX RM B Power Supply



## 3.2 System Requirements

To connect to the DCX Web Page Interface you will need a PC running a Windows<sup>®1</sup> operating system with a Google Chrome<sup>™2</sup> or Microsoft Edge<sup>®1</sup> web browser software.

NOTICE	
	The DCX RM B power supply is not compatible with network scanning software. If your local network uses these types of programs, the DCX RM B IP address must be placed in an exclusion list.

NOTICE	
	A shielded Ethernet cable should be used to connect to the DCX RM B Web Page Interface to prevent possible EMI (Electromagnetic Interference) issues.

---

1. Windows 10, Windows 11, and Microsoft Edge are registered trademarks of Microsoft Corporation.  
2. Google Chrome is a trademark of Google LLC.

## 3.3 Point to Point Connection (Windows 10 or Windows 11)

To connect directly to the DCX Power Supply Web Page Interface using a PC with Windows 10<sup>®1</sup> or Windows 11<sup>®1</sup> operating system, complete the following steps:

1. Connect the power supply to a computer via the Ethernet port
2. Turn on the power supply
3. On your PC, click the Start button on the taskbar and search for **Control Panel**
4. Select **View Large Icons** on the top right corner
5. Select **Network and Sharing Center**
6. Select **Change adapter settings**

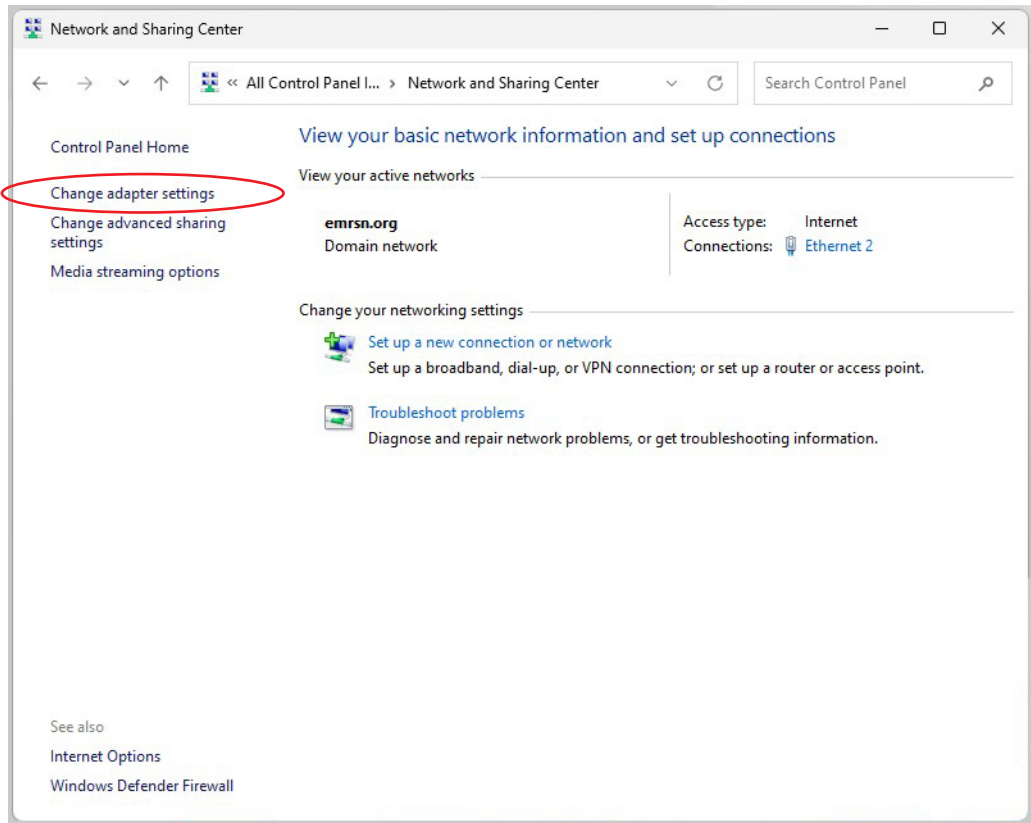

1. Windows 10, Windows 11, and Microsoft Edge are registered trademarks of Microsoft Corporation.

7. Right click on **Ethernet2** and select **Properties** to bring up the **Networking** tab

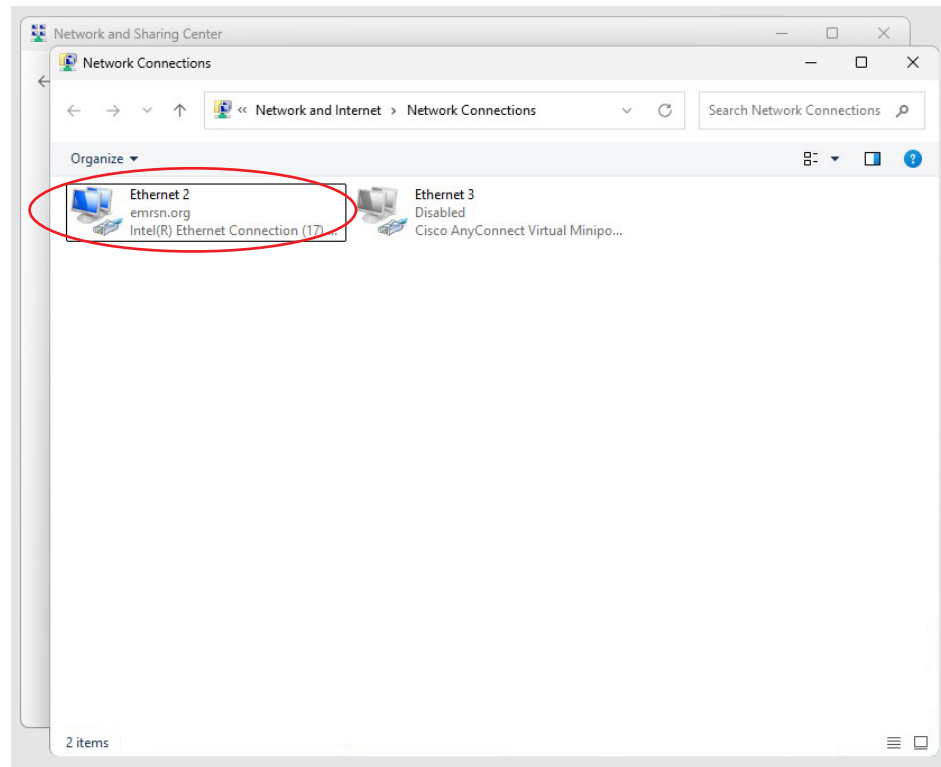

8. Highlight **Internet Protocol Version 4 (TCP/IPv4)** from the list and click on **Properties**

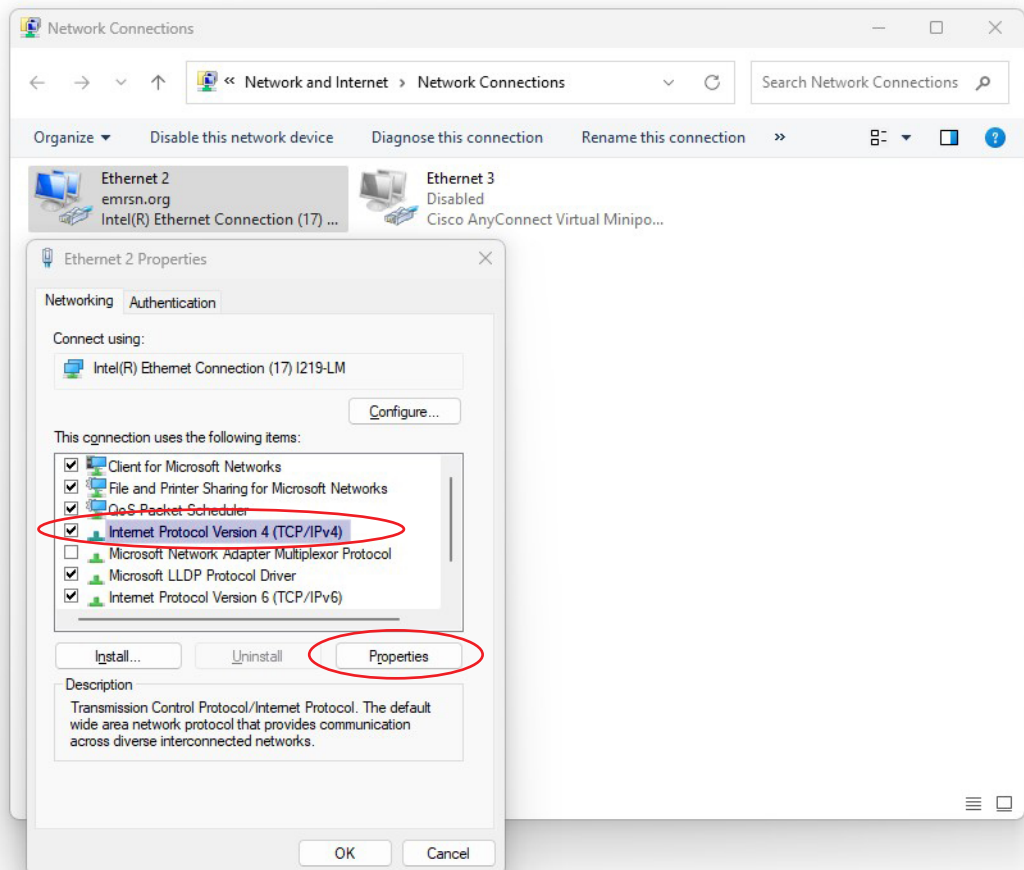

9. Use the following IP address:

**IP address:** 192.168.10.101

**Subnet mask:** 255.255.255.0

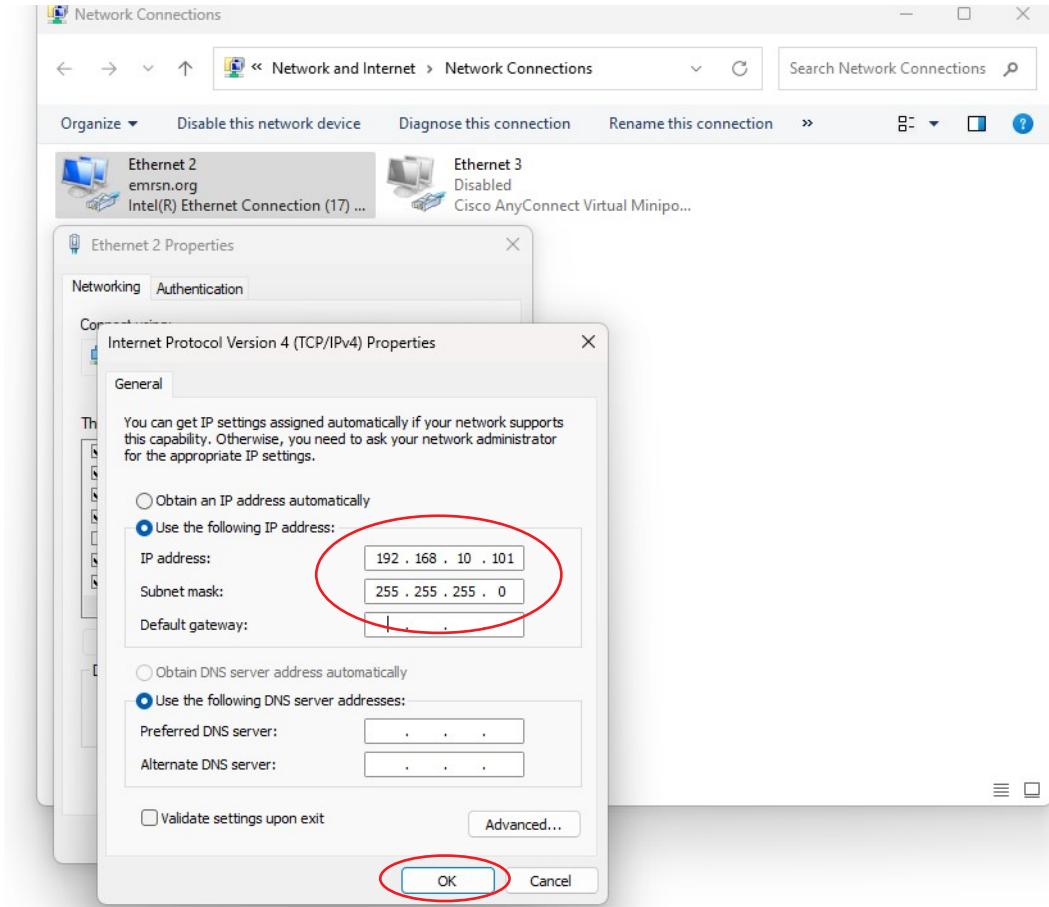

10. Click **OK**. Close the rest of the dialog boxes

11. Open the Google Chrome™ or Microsoft Edge® web browser

12. In the address bar type the following address: <http://192.168.10.100>. Press **Enter**

13. This will bring up the DCX RM B Web Page Interface

14. Enter a user ID number (any number up to 9 digits long)

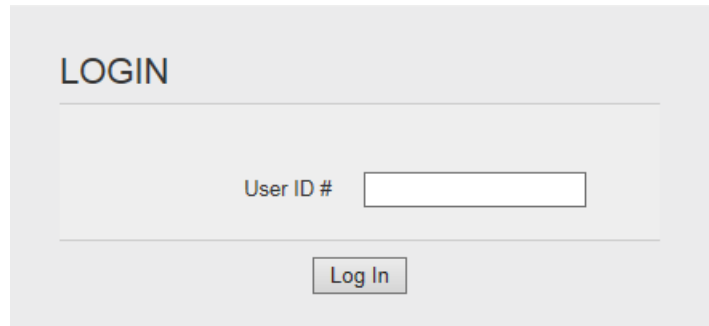

---

## **Chapter 4: The Web Page Interface**

---

<b>4.1</b>	<b>Web Page Interface Overview</b> .....	<b>18</b>
<b>4.2</b>	<b>Login</b> .....	<b>19</b>
<b>4.3</b>	<b>IP Setup</b> .....	<b>20</b>
<b>4.4</b>	<b>Weld Preset</b> .....	<b>22</b>
<b>4.5</b>	<b>I/O Diagnostics</b> .....	<b>24</b>
<b>4.6</b>	<b>Seek &amp; Weld Graphs</b> .....	<b>25</b>
<b>4.7</b>	<b>Horn Signature</b> .....	<b>27</b>
<b>4.8</b>	<b>System Information</b> .....	<b>29</b>
<b>4.9</b>	<b>Alarm Log</b> .....	<b>30</b>

## 4.1 Web Page Interface Overview

The DCX RM B Web Page Interface allows you to set a weld preset, diagnose and configure the power supply I/O, perform horn scans and seeks, view system information, and to view and download the system alarms, history and events logs.

**Figure 4.1** Web Page Interface Overview

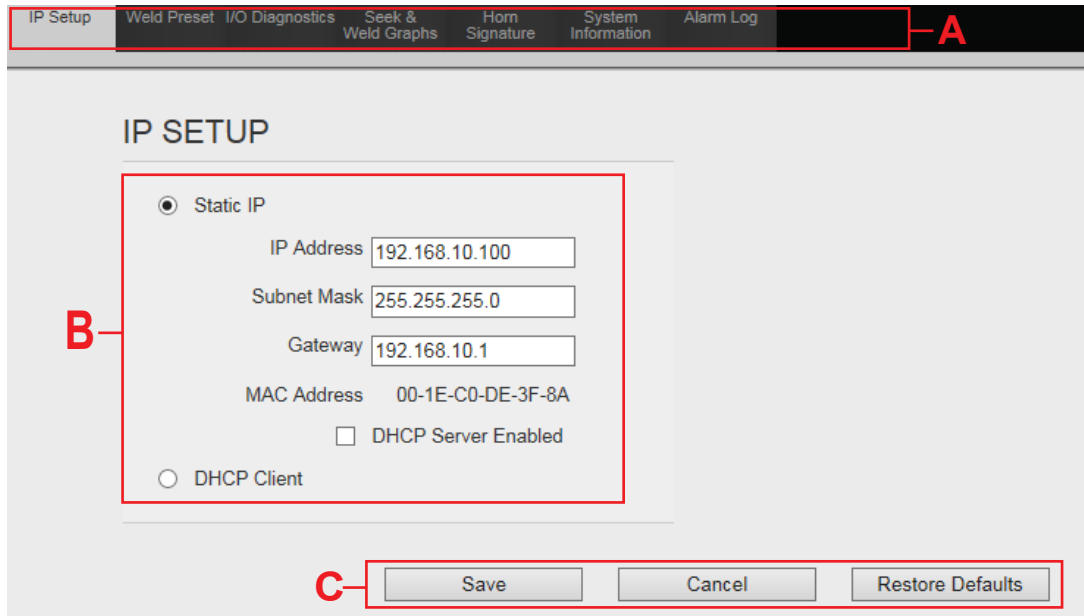

**Table 4.1** Web Page Interface Overview

Item	Name	Description
A	Menu Navigation Tabs	The menu navigation tabs are always displayed on the upper section of the web pages. They provide access to the following menu options: <a href="#">4.3 IP Setup</a> <a href="#">4.4 Weld Preset</a> <a href="#">4.5 I/O Diagnostics</a> <a href="#">4.6 Seek &amp; Weld Graphs</a> <a href="#">4.7 Horn Signature</a> <a href="#">4.8 System Information</a> <a href="#">4.9 Alarm Log</a>
B	Menu Display	Displays the contents of the currently selected menu option.
C	Command Buttons	Different command buttons allow to save settings, cancel changes, restore default settings, and to perform other functions specific to each menu.  Save, Cancel, and Restore Defaults is page specific. They only operate on the page displayed.

## 4.2 Login

When connection is established with the DCX RM B Web Page Interface, the Login page will display. Enter a unique user ID number. The user ID is numeric only and up to 9 digits long. This number allows for keeping track of user access.

**Figure 4.2** Login

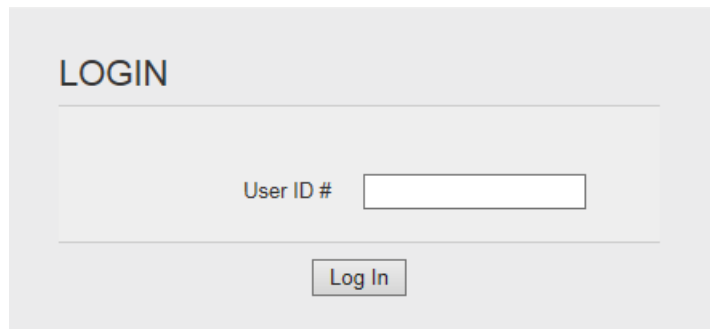

The screenshot shows a login interface with the following elements:

- The word "LOGIN" is displayed at the top left of the form area.
- A horizontal line separates the title from the input field.
- The text "User ID #" is positioned to the left of a rectangular text input field.
- Another horizontal line is located below the input field.
- A "Log In" button is centered below the input field.

## 4.3 IP Setup

Use this menu to setup the DCX RM B power supply's network settings. DCX RM B power supply's default IP setting is Static IP with the address shown in the figure below.

**Figure 4.3** IP Setup Menu

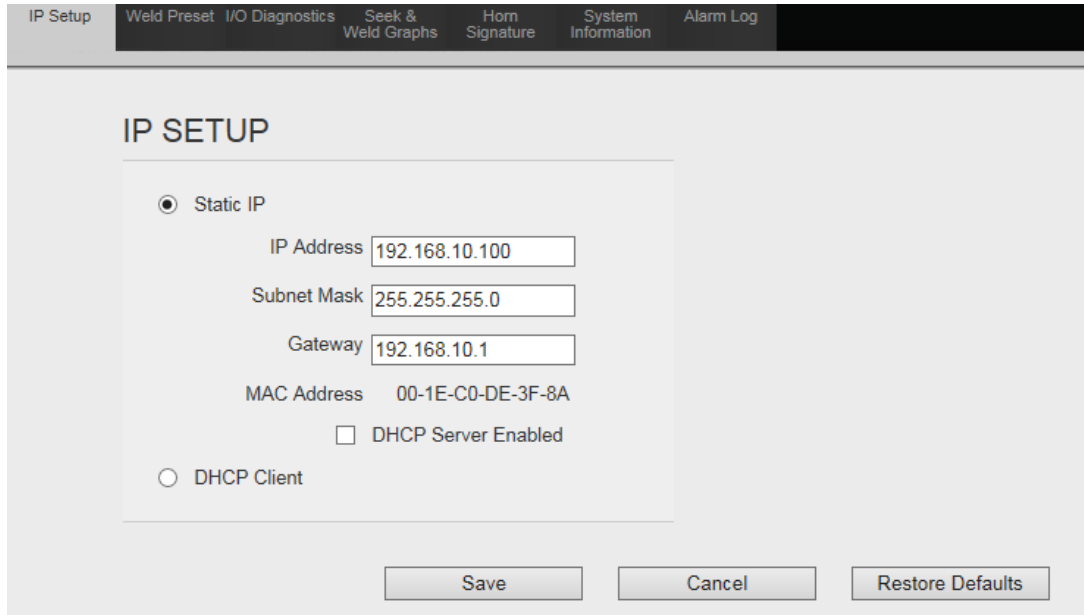

**Table 4.2** IP Setup Menu Option

Name	Description
<b>IP SETUP</b>	
Static IP	Select this option to manually assign an IP address to the DCX RM B power supply. The DCX RM B power supply will alert if an invalid IP address setting is entered.
IP Address	The IP address assigned to the DCX RM B power supply.
Subnet Mask	The mask used to determine to what subnet the DCX RM B power supply's address belongs to.
Gateway	The gateway address assigned to the network for communication with other computers or networks.
MAC Address	Displays the MAC address assigned to the DCX RM B power supply.
DHCP Server Enabled	Select this option to have DCX RM B power supply assign IP addresses to any devices connected to it. This facilitates connecting a computer or laptop point to point (P2P) with the DCX RM B power supply.  <b>NOTICE</b> Connecting a DCX RM B power supply with DHCP server enabled to a network which already has a device working as a DHCP server will cause connectivity problems.

**Table 4.2** IP Setup Menu Option

Name	Description
DHCP Client	Select this option to have the DCX RM B power supply automatically request an IP address from a DHCP Server. The IP address will be grayed out.

NOTICE	
	All changes on this menu take effect on the next power-up.

At any time you may determine the DCX RM B power supply's IP address by going through the associated registers using the front panel LCD. A Cold Start can also be performed to take your power supply back to its factory default IP address. For details on navigating the DCX RM B registers or performing a Cold Start, consult your power supply manual.

NOTICE	
	Beware that other settings will also be reset to their defaults when a Cold Start is executed.

## 4.4 Weld Preset

Use this menu to set weld parameters, seek options, and power-up actions. Use the command buttons on the bottom to save settings, cancel changes, or to restore to factory default settings.

**Figure 4.4** Weld Preset Menu

The screenshot shows the 'Weld Preset' menu with the following sections and controls:

- WELD Section:**
  - Amplitude:** Weld Amplitude (%) set to 100, Amplitude Ramp (ms) set to 80. Includes an 'External' checkbox.
  - Frequency:** Digital Tune (Hz) set to 30000, Internal Offset (Hz) set to 0. Includes checkboxes for 'External Offset', 'End of Weld Store' (checked), 'Clear memory with Reset', 'Clear memory before Seek' (checked), and 'Set with Horn Scan'.
- SEEK Section:**
  - Seek Ramp (ms) set to 80, Seek Time (ms) set to 500, Frequency Offset (Hz) set to 0.
  - 'Timed Seek' checkbox is unchecked.
- POWER ON Section:**
  - Radio buttons for 'Off', 'Seek' (selected), and 'Scan'.
  - 'Clear Memory' checkbox is checked.
- MISC SETUP Section:**
  - 'Alarms - Reset Required' checkbox is checked.
  - Radio buttons for 'Frequency out on pin 1(JP3 2-3)' and 'Amplitude out on pin 14(JP3 1-2)' (selected).

At the bottom, there are three buttons: 'Save', 'Cancel', and 'Restore Defaults'.

**Table 4.3** Weld Preset Menu Option

Name	Description
<b>Amplitude</b>	
Weld Amplitude (%)	The amplitude of ultrasonic energy that will be delivered by the DCX RM B power supply. Valid range is between 10 to 100 (10% to 100% amplitude).
Amplitude Ramp (ms)	The time it takes for the amplitude to ramp up to 100% when the External Start signal is applied. If amplitude setting is lower than 100%, ramp time will be adjusted accordingly.
External	Select the External check box to control the amplitude using an analog input from the user I/O connector.

**Table 4.3** Weld Preset Menu Option

Name	Description
<b>Frequency</b>	
Digital Tune (Hz)	Starting frequency set from horn signature or manually entered.
Internal Offset (Hz)	Sets the frequency offset from the Web Page as either a positive or negative value offset from digital tune.
External Offset	Select the External Offset check box to control the frequency offset using an analog input from the user I/O connector (J3).
End of Weld Store	Select to save the frequency at the end of the weld as the starting frequency for the following weld.
Clear memory with Reset	Select to clear memory with reset. Memory offset will be set to 0 when a Reset is applied. Reset can come from external I/O, front panel, or web page interface (seek or horn scan).
Clear Memory before Seek	Select to clear memory before seek. Memory offset will be set to 0 before Seek is applied.
Set with Horn Scan	Select to set Digital Tune frequency with a successfully completed horn scan.
<b>Seek</b>	
Seek Ramp (ms)	The time it will take the power supply to ramp-up when performing a seek.
Seek Time (ms)	The duration of a seek.
Frequency Offset (Hz)	The frequency offset applied to the power supply operating frequency.
Timed Seek	Select this check box to have the power supply perform a seek every 60 seconds. Seeks will be timed from the moment sonics was last activated.
<b>Power On</b>	
Off	Select this option to disable power-on actions.
Seek	Select this option to have the power supply perform a seek on power-up.
Scan	Select this option to have the power supply perform a horn scan on power-up.
<b>Misc Setup</b>	
Alarms - Reset Required	This option determines if the alarm is latched or not. Latched alarms require a reset before another cycle can start.
Frequency on Pin 1*	Select this check box to enable Frequency out on pin 1. Jumper JP3 must be in position 2-3.
Amplitude out on pin 14	Select this check box to enable Amplitude out on pin 14. Jumper JP3 must be in position 1-2. This is the default setting.

\* Refer to DCX RM B Power Supply manual, Section Frequency Output Setting to enable Frequency out on pin 1.

## 4.5 I/O Diagnostics

Use this menu to monitor and control the DCX RM B power supply digital and analog I/O.

**Figure 4.5** I/O Diagnostics Menu

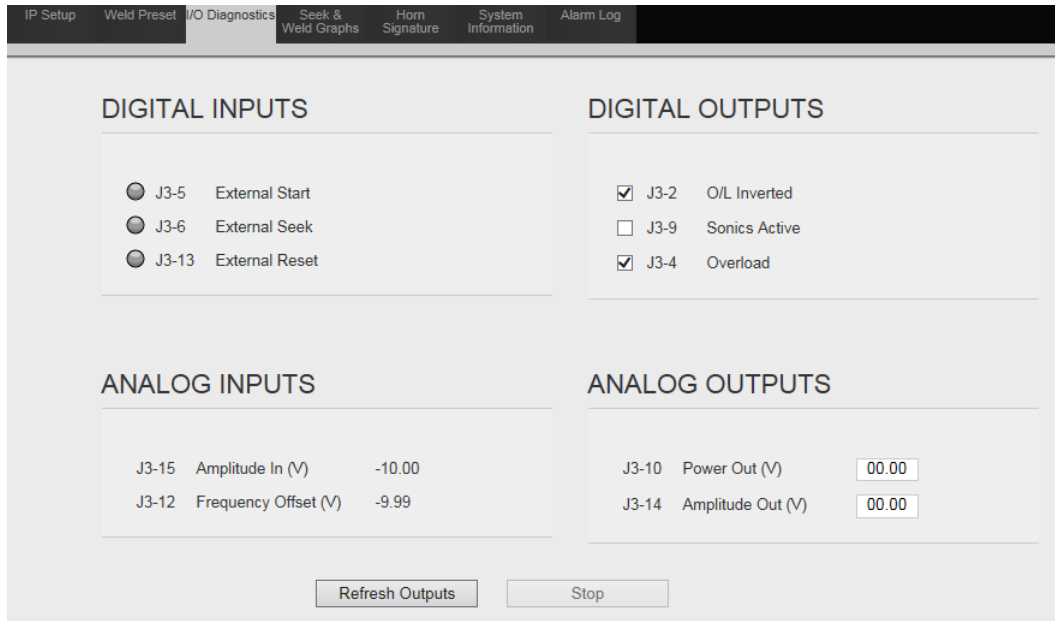

**Table 4.4** I/O Diagnostics Menu Option

Name	Description
<b>Digital Inputs</b>	
J3-5 External Start	Indicate if the digital inputs are active.
J3-6 External Seek	
J3-13 External Reset	
<b>Digital Outputs</b>	
J3-2 O/L Inverted	Select/clear check boxes to toggle available digital outputs on/off.
J3-9 Sonics Active	
J3-4 Overload	
<b>Analog Inputs</b>	
J3-15 Amplitude In (V)	Displays the current analog input values.
J3-12 Frequency Offset (V)	
<b>Analog Outputs</b>	
J3-10 Power Out (V)	Allows control of analog output values.
J3-14 Amplitude Out (V)	

## 4.6 Seek & Weld Graphs

Use this menu to test your system. This feature allows you to capture 5 seconds of welding data which you can both view and export. The weld data graph is provided with 6 available parameters: Amplitude, Power, Phase, PWM Amplitude, Current, and Frequency. Each parameter has a checkbox to the left of its name.

Only checked parameters will be displayed. While in this menu, if the Weld is being run from external I/O or the custom LCD, the graph can be also displayed on the screen by using the "Update Graph" button.

**Figure 4.6** Seek & Weld Graphs Menu

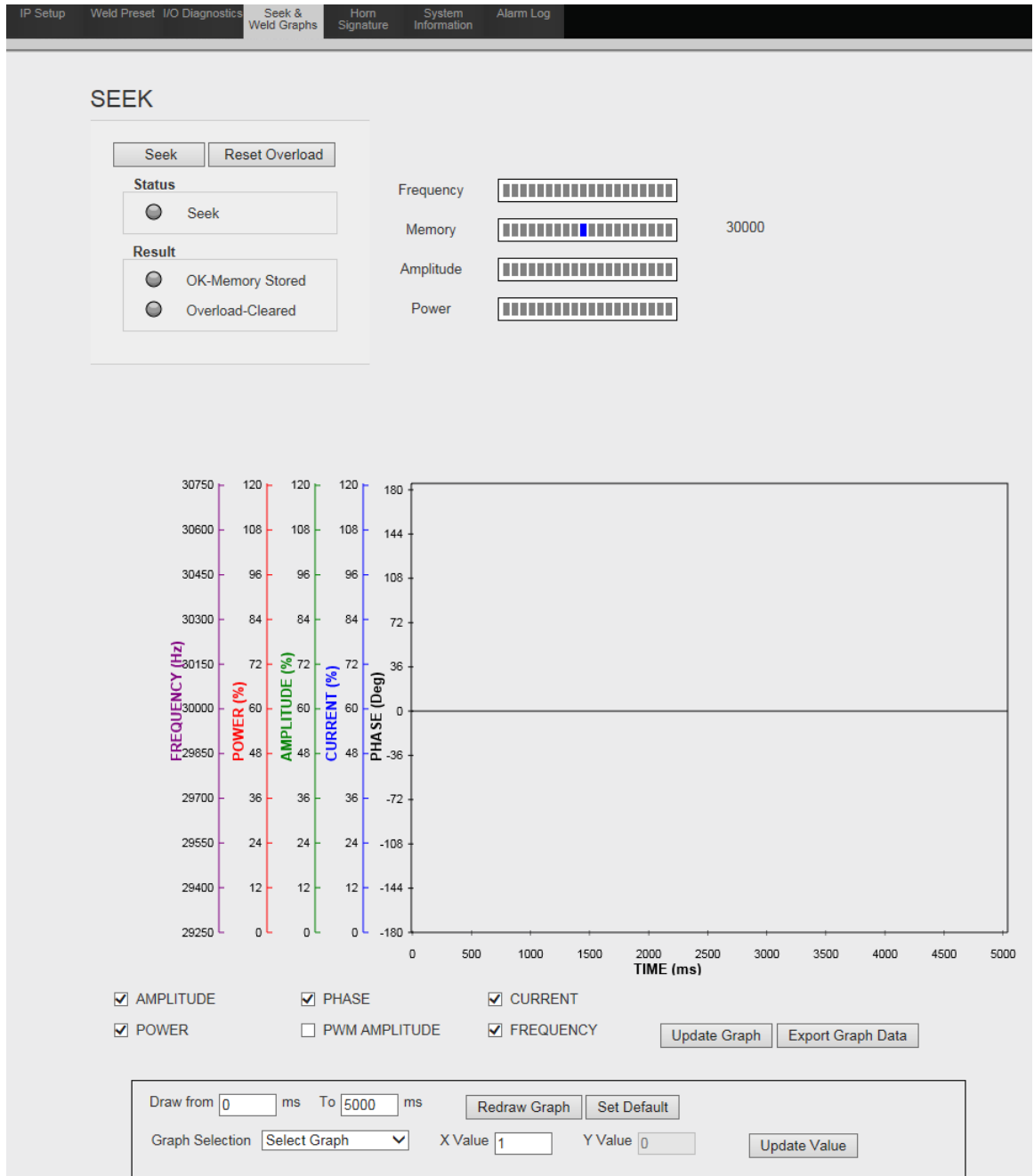

**Table 4.5** Seek & Weld Graphs Menu Option

Name	Description
<b>Seek</b>	
Seek	Click to perform a seek cycle.
Reset Overload	Click to reset an overload condition.
OK - Memory Stored	Indicates that the horn operating frequency was stored in the DCX RM B power supply memory.
Overload - Cleared	Indicates that test resulted in an overload and the memory has been cleared.
Frequency	Monitors the horn operating frequency.
Memory	Displays the frequency stored in the DCX RM B power supply memory.
Amplitude	Displays the percentage of converter amplitude.
Power	Displays the percentage of power output.
Update Graph	Click to get the value of all the parameter and draw the graph for Phase, Current, Amplitude, Power, and Frequency parameters vs Time on the Y axis.
Export Graph Data	Click to export the Weld Graph data with Weld Preset settings to CSV file.
Draw from... to...	Select the <i>from</i> and <i>to</i> time values to zoom into the desired graph region.
Redraw Graph	Click to redraw the same graph with those parameters which are checked with the Time parameter on Y axis.
Set Default	Click to return the sample rate, start time, end time and graph selection to default settings.
Graph Selection	Select a parameter and enter a particular X time value to obtain the corresponding Y value at that particular time.
Update Value	Click to update the Y value for the given graph selection.

## 4.7 Horn Signature

Use this menu to diagnose your ultrasonic horn. When performing a horn scan, ideally, there will be only one resonant frequency. The Horn Signature graph is provided with 3 available parameters: Phase, Current, and Amplitude. The horn Signature Graph can be both viewed and exported.

Each parameter has a checkbox to the left of its name. Only checked parameters will be displayed.

**Figure 4.7** Horn Signature Menu

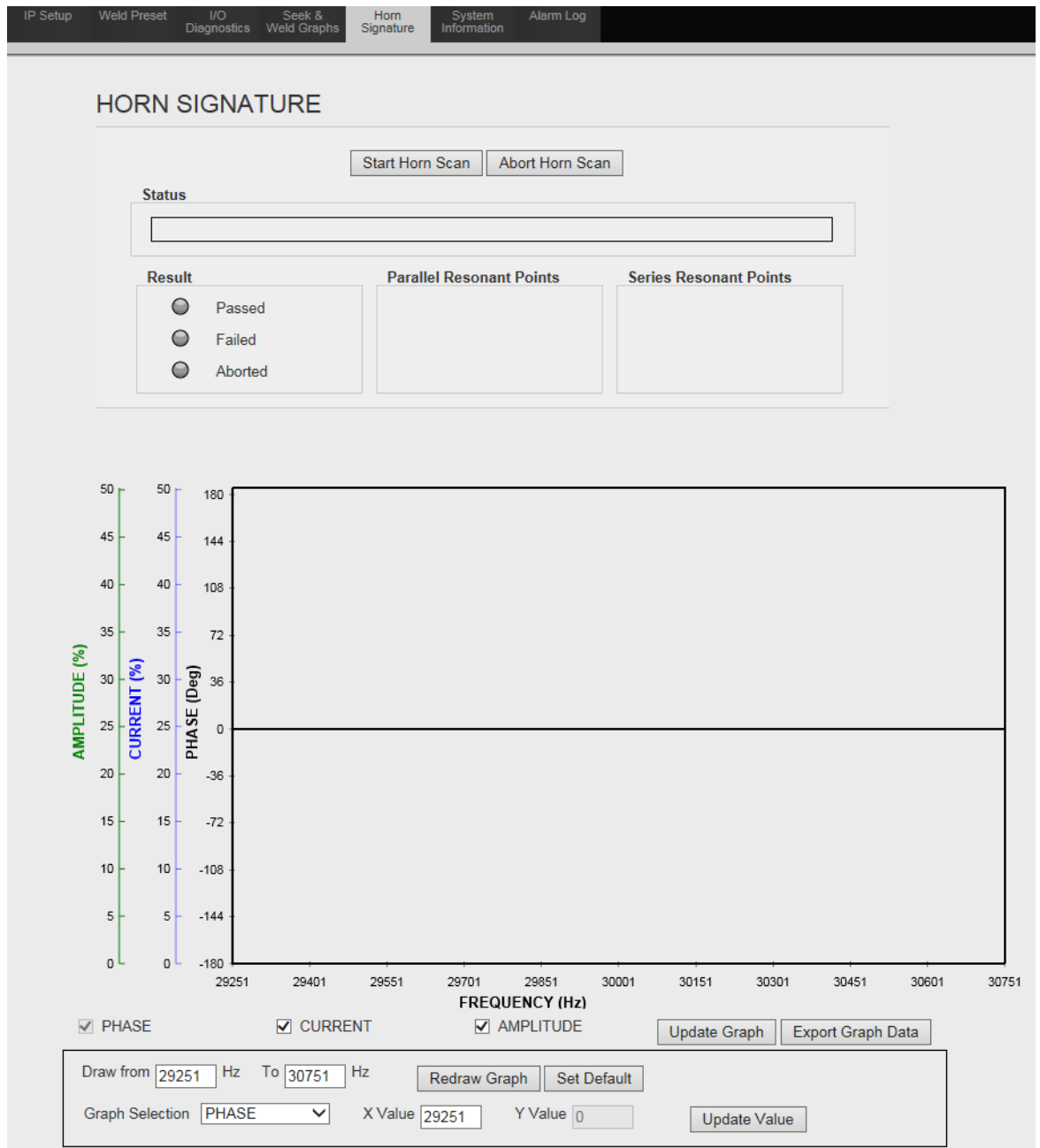

**Table 4.6** Horn Signature Menu Option

Name	Description
<b>Horn Signature</b>	
Start Horn Scan	Click to initiate the horn scan.
Abort Horn Scan	Click to abort the horn scan.
Status	Indicates the horn scan progress.
Result	Indicates if the horn scan passed, failed, or if the operation was aborted.
Parallel Resonant Points	<p>Displays the parallel resonant frequencies of the ultrasonic horn. The parallel resonant frequency is the operating frequency of the ultrasonic stack.</p> <p><b>NOTICE</b> If multiple parallel frequencies are found, they will all be listed. The frequency at which the ultrasonic stack is running will be displayed in blue.</p>
Series Resonant Points	Displays the series resonant frequencies of the ultrasonic horn.
Update Graph	Click to draw the graph of the last horn scan.
Export Graph Data	Click to export the Weld Graph data with Weld Preset settings to CSV file.
Draw from... to...	Select the <i>from</i> and <i>to</i> time values to zoom into the desired graph region.
Redraw Graph	Click to redraw the same graph with those parameters which are checked with the Time parameter on Y axis.
Set Default	Click to return the sample rate, start time, end time and graph selection to default settings.
Graph Selection	Select a parameter and enter a particular X time value to obtain the corresponding Y value at that particular time.
Update Value	Click to update the Y value for the given graph selection.

## 4.8 System Information

Use this menu to view information about your DCX RM B power supply. Have the information on this screen available when calling Branson for troubleshooting help.

**Figure 4.8** System Information Menu

The screenshot shows a menu with several options: IP Setup, Weld Preset, I/O Diagnostics, Seek & Weld Graphs, Horn Signature, System Information (highlighted), and Alarm Log. The System Information screen is divided into two columns: SYSTEM and POWER SUPPLY. The SYSTEM column lists: System (DCX RM B), Display (Monochrome LCD), LCD Software Version (3.1), LCD CRC (0000DEBB), WebSite Version (V1.3.9), and Controller Version (1.2). The POWER SUPPLY column lists: Power Level (1500 Watts), Frequency (30 kHz), Serial Number (DEFAULT1234), P/S Version (V1.3.9), and P/S CRC (000036C1).

SYSTEM		POWER SUPPLY	
System	DCX RM B	Power Level	1500 Watts
Display	Monochrome LCD	Frequency	30 kHz
LCD Software Version	3.1	Serial Number	DEFAULT1234
LCD CRC	0000DEBB	P/S Version	V1.3.9
WebSite Version	V1.3.9	P/S CRC	000036C1
Controller Version	1.2		

**Table 4.7** System Information Menu Option

Name	Description
<b>System</b>	
System	Displays the DCX RM B power supply model name.
Display	Displays the type of front panel user interface on the DCX RM B power supply.
LCD Software Version	Displays the LCD software version number.
LCD CRC	Displays the CRC code of the LCD software.
WebSite Version	Displays the Web Page version number.
Controller Version	Displays the controller version.
<b>Power Supply</b>	
Power Level	Displays the power supply wattage.
Frequency	Displays the power supply operating frequency.
Serial Number	Displays the power supply serial number.
P/S Version	Displays the power supply software version number.
CRC	Displays the CRC code of the power supply controller software.

## 4.9 Alarm Log

Use this screen to view the DCX RM B power supply alarm history. The alarms can be sorted by alarm number or alarm type. Alarms can be exported to an Excel® file.

NOTICE	
	Only the last 100 alarms are stored in memory.

**Figure 4.9** Alarm Log Menu

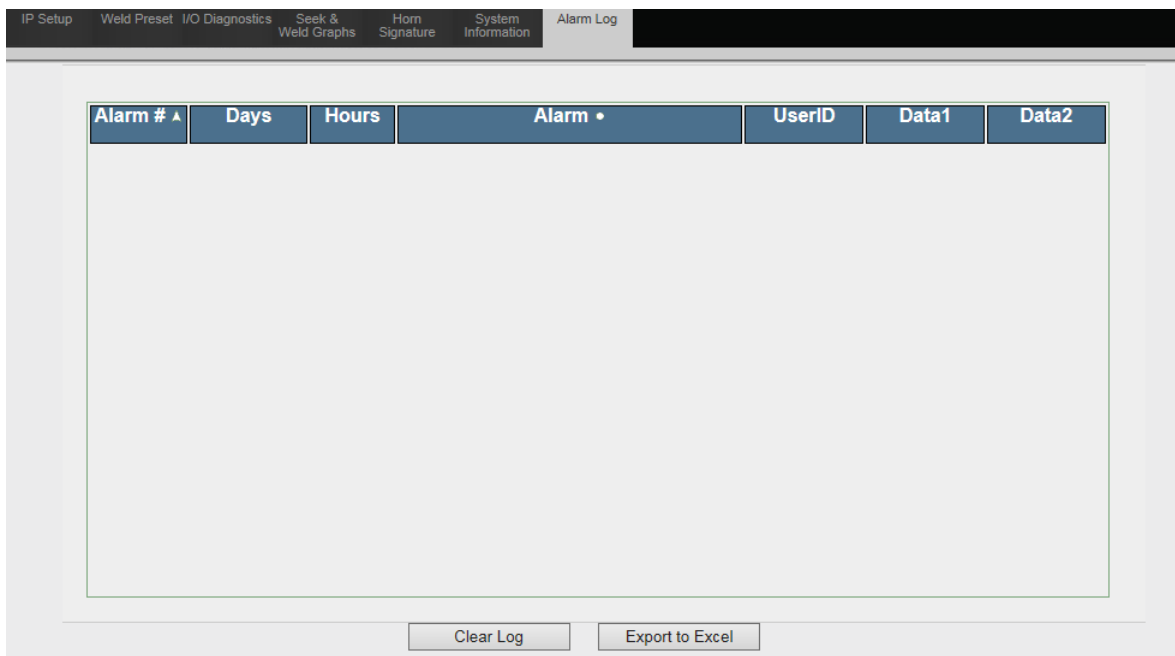

**Table 4.8** Alarm Log Menu Option

Name	Description
Alarm #	A unique alarm identification number.
Days	The DCX RM B power supply units do not feature an integrated real time clock. Alarm date and time account for the power-on hours from the moment the DCX RM B power supply was first turned on.
Hours	
Alarm	Displays a brief alarm description.
UserID	The ID number of the user logged in at when the alarm occurred. Will display zero if the alarm occurs from an external weld.

**Table 4.8** Alarm Log Menu Option

Name	Description
Data1	For future use.
Data2	
<b>Command Buttons</b>	
Clear Log	Click to clear the alarm log.
Export to Excel <sup>®</sup>	Click to download an Excel <sup>®</sup> spreadsheet file of the alarm log.



---

## **Appendix A: Manual's Revisions**

---

**A.1 Manual's Revisions . . . . . 34**

## A.1 Manual's Revisions

Refer to the table below for the appropriate manual revision depending on your Power Supply's manufacturing date.

**Table A.1** Manual's Revisions

Manual's Revisions	Power Supply's Manufacturing Date	
	From	To
00	April 2022	March 2026
01	April 2026	To date

**Figure A.1** Manufacturing date on the Information label

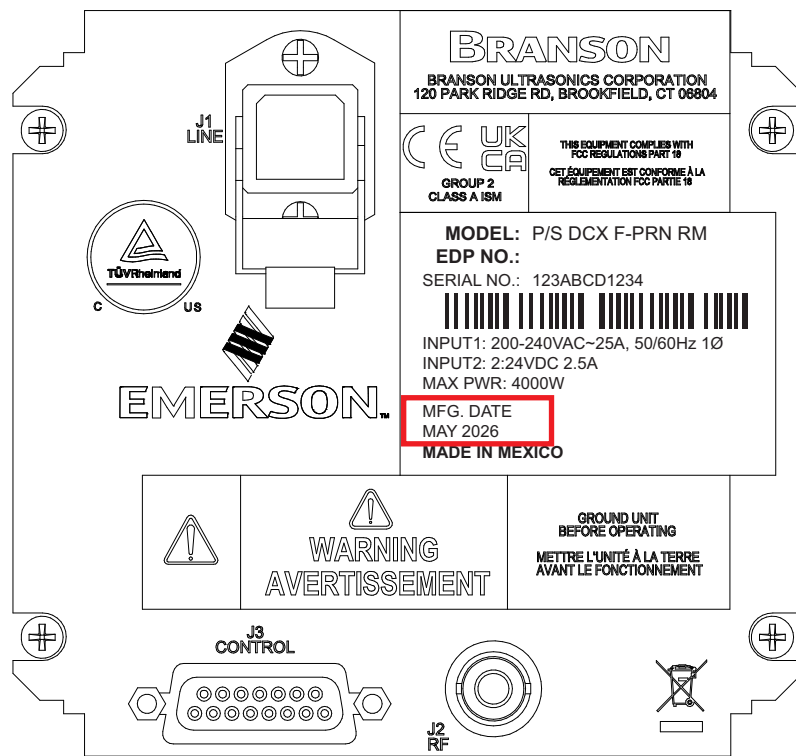

**Figure A.2** Location of the Information label on the back of the DCX RM B Power Supply

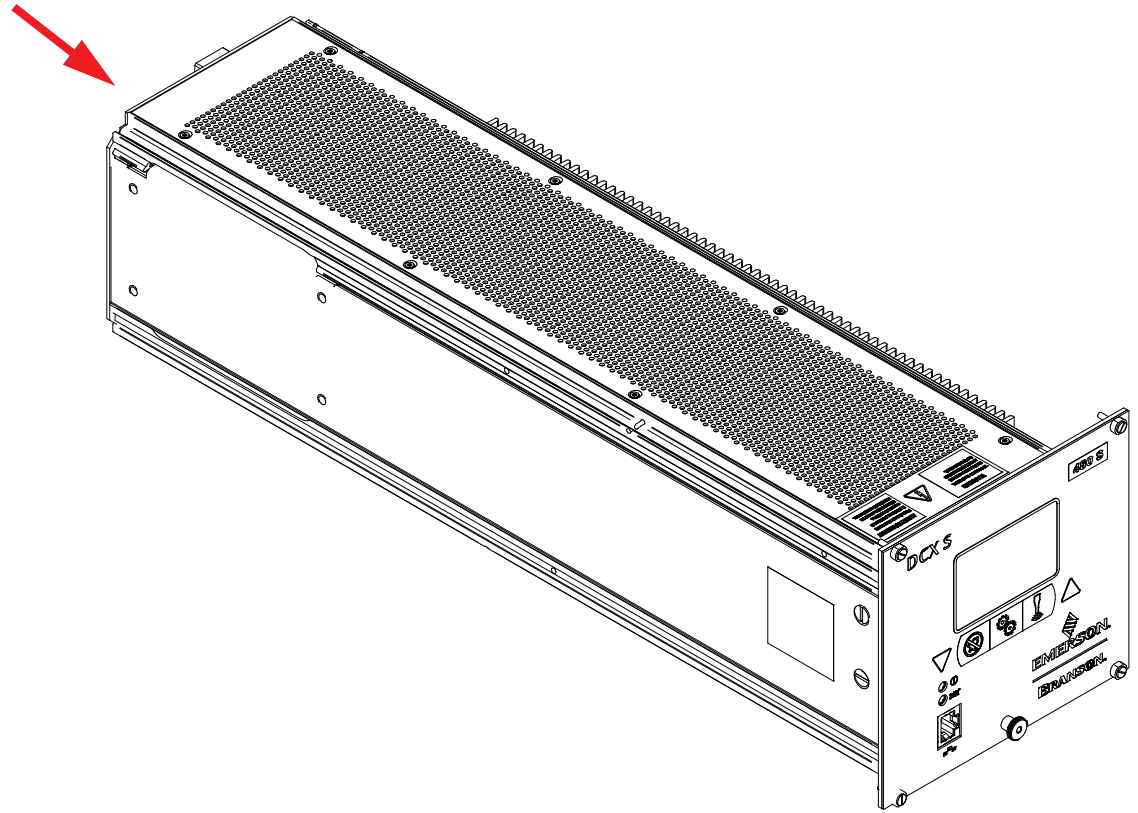



---

# Index

---

**A**

- Abort Horn Scan 28
- Alarm 30
- Alarm # 30
- Alarm Log 30
- Alarms - Reset Required 23
- Amplitude 22, 26
- Amplitude Ramp (ms) 22
- Analog Inputs 24
- Analog Outputs 24

**C**

- Clear Log 31
- Clear Memory before Seek 23
- Clear memory with Reset 23
- Command Buttons 18, 31
- Contact Branson 6
- Controller Version 29
- CRC 29

**D**

- Data1 31
- Data2 31
- Days 30
- DHCP Client 21
- DHCP Server Enabled 20
- Digital Inputs 24
- Digital Outputs 24
- Digital Tune (Hz) 23
- Display 29
- Draw from... to... 26, 28

**E**

- Emissions 5
- End of Weld Store 23
- Ethernet Port 12
- Export Graph Data 26, 28
- Export to Excel 31
- External 22

**F**

- Frequency 23, 26, 29
- Frequency Offset (Hz) 23

**G**

- Gateway 20
- General Precautions 4

Graph Selection 26, 28

## H

Horn Signature 27, 28

Hours 30

## I

I/O Diagnostics 24

Intended Use of the System 5

Internal Offset (Hz) 23

Introduction 8

IP Address 20

IP Setup 20

## J

J3-10 Power Out (V) 24

J3-12 Frequency Offset (V) 24

J3-13 External Reset 24

J3-14 Amplitude Out (V) 24

J3-15 Amplitude In (V) 24

J3-2 O/L Inverted 24

J3-4 Overload 24

J3-5 External Start 24

J3-6 External Seek 24

J3-9 Sonics Active 24

## L

LCD CRC 29

LCD Software Version 29

Login 19

## M

MAC Address 20

Memory 26

Menu Display 18

Menu Navigation Tabs 18

Misc Setup 23

Models Covered 9

## O

Off 23

OK - Memory Stored 26

Overload - Cleared 26

## P

P/S Version 29

Parallel Resonant Points 28

Point to Point Connection 14

Power 26

Power Level 29

Power On 23

Power Supply 29

## R

- Redraw Graph 26, 28
- Reset Overload 26
- Result 28

## S

- Safety and Support 1
- Safety Requirements 2
- Scan 23
- Seek 23, 26
- Seek & Weld Graphs 25
- Seek Ramp (ms) 23
- Seek Time (ms) 23
- Serial Number 29
- Series Resonant Points 28
- Set Default 26, 28
- Start Horn Scan 28
- Static IP 20
- Status 28
- Subnet Mask 20
- Symbols 2
- System 29
- System Information 29
- System Requirements 13

## T

- Timed Seek 23

## U

- Update Graph 26, 28
- Update Value 26, 28
- UserID 30

## W

- Warnings 2
- Web Page Interface 18, 34
- WebSite Version 29
- Weld Amplitude (%) 22
- Weld Preset 22

