



**EMERSON**<sup>TM</sup>

**Original Instructions  
4000860 - REV. 01**

The screenshot displays the configuration interface for the DCX S Rack Mount Version. The interface is divided into three main sections: WELD, SEEK, and POWER ON. At the top, there is a navigation bar with tabs for IP Setup, Weld Preset, IO Diagnostics, Seek & Weld Graphs, Horn Signature, System Information, I/O Configuration, and Alarm Log. The WELD section includes Amplitude settings (Weld Amplitude (%) at 100, Amplitude Ramp (ms) at 80, and an External checkbox), Frequency settings (Digital Tune (Hz) at 30000, Internal Offset (Hz) at 0, and checkboxes for External Offset, End of Weld Store, Clear memory with Reset, Clear memory before Seek, and Set with Horn Scan). The SEEK section includes Seek Ramp (ms) at 80, Seek Time (ms) at 500, Frequency Offset (Hz) at 0, and checkboxes for Timed Seek and Clear Memory. The POWER ON section includes radio buttons for Off, Seek (selected), and Scan, and a checked checkbox for Clear Memory. A MISC SETUP section at the bottom has a checked checkbox for Alarms - Reset Required. At the bottom of the interface are buttons for Save, Cancel, and Restore Defaults.

# DCX S Web Page

Rack Mount Version

# Instruction Manual

**Branson Ultrasonics Corp.**  
120 Park Ridge Road  
Brookfield, CT 06804  
(203) 796-0400  
<http://www.bransonultrasonics.com>

**BRANSON**

## Manual Change Information

At Branson, we strive to maintain our position as the leader in ultrasonics plastics joining, metal welding, cleaning and related technologies by continually improving our circuits and components in our equipment. These improvements are incorporated as soon as they are developed and thoroughly tested.

Information concerning any improvements will be added to the appropriate technical documentation at its next revision and printing. Therefore, when requesting service assistance for specific units, note the Revision information found on this document, and refer to the printing date which appears on this page.

## Copyright and Trademark Notice

Copyright © 2026 Branson Ultrasonics Corporation. All rights reserved. Contents of this publication may not be reproduced in any form without the written permission of Branson Ultrasonics Corporation.

Mylar is a registered trademark of DuPont Teijin Films.

Loctite is a registered trademark of Loctite Corporation.

WD-40 is a registered trademark of WD-40 Company.

Windows 10, Windows 11, and Microsoft Edge are registered trademarks of Microsoft Corporation.

Google Chrome is a trademark of Google LLC.

Other trademarks and service marks mentioned herein are held by their respective owners.

## Foreword

Congratulations on your choice of a Branson Ultrasonics Corporation system!

The Branson DCX S Power Supply system is process equipment for the joining of plastic parts using ultrasonic energy. It is the newest generation of product using this sophisticated technology for a variety of customer applications. This Instruction Manual is part of the documentation set for this system, and should be kept with the equipment.

Thank you for choosing Branson!

## Introduction

This manual is arranged into several structured chapters which will help you find the information you may need to know to safely handle, install, set up, program, operate, and/or maintain this product. Please refer to the [Table of Contents](#) and/or the [Index](#) of this manual to find the information you may be looking for. In the event you require additional assistance or information, please contact our Product Support department (see [1.3 How to Contact Branson](#) for information on how to contact them) or your local Branson representative.



---

# Table of Contents

---

**Chapter 1: Safety and Support**

|     |  |   |
|-----|--|---|
| 1.1 | Safety Requirements and Warnings . . . . . | 2 |
| 1.2 | General Precautions. . . . .               | 4 |
| 1.3 | How to Contact Branson. . . . .            | 6 |

**Chapter 2: Introduction**

|     |                          |   |
|-----|--------------------------|---|
| 2.1 | Introduction . . . . .   | 8 |
| 2.2 | Models Covered . . . . . | 9 |

**Chapter 3: Connecting to the Web Page Interface**

|     |  |    |
|-----|--|----|
| 3.1 | Locating the Ethernet Port . . . . .                             | 12 |
| 3.2 | System Requirements . . . . .                                    | 13 |
| 3.3 | Point to Point Connection (Windows 10® or Windows 11®) . . . . . | 14 |

**Chapter 4: The Web Page Interface**

|      |                                       |    |
|------|---------------------------------------|----|
| 4.1  | Web Page Interface Overview . . . . . | 18 |
| 4.2  | Login . . . . .                       | 19 |
| 4.3  | IP Setup. . . . .                     | 20 |
| 4.4  | Weld Preset . . . . .                 | 22 |
| 4.5  | I/O Diagnostics . . . . .             | 24 |
| 4.6  | Seek & Weld Graphs . . . . .          | 26 |
| 4.7  | Horn Signature . . . . .              | 28 |
| 4.8  | System Information. . . . .           | 30 |
| 4.9  | I/O Configuration . . . . .           | 31 |
| 4.10 | Alarm Log . . . . .                   | 34 |

**Appendix A: Manual's Revisions**

|     |                              |    |
|-----|------------------------------|----|
| A.1 | Manual's Revisions . . . . . | 38 |
|-----|------------------------------|----|



---

# List of Figures

---

## Chapter 1: Safety and Support

## Chapter 2: Introduction

## Chapter 3: Connecting to the Web Page Interface

Figure 3.1 DCX S Power Supply . . . . .12

## Chapter 4: The Web Page Interface

Figure 4.1 Web Page Interface Overview . . . . .18

Figure 4.2 Login . . . . .19

Figure 4.3 IP Setup Menu . . . . .20

Figure 4.4 Weld Preset Menu . . . . .22

Figure 4.5 I/O Diagnostics Menu. . . . .24

Figure 4.6 Seek & Weld Graphs Menu . . . . .26

Figure 4.7 Horn Signature Menu. . . . .28

Figure 4.8 System Information Menu . . . . .30

Figure 4.9 I/O Configuration Menu . . . . .31

Figure 4.10 Alarm Log Menu . . . . .34

## Appendix A: Manual's Revisions

Figure A.1 Manufacturing date on the Information label. . . . .38

Figure A.2 Location of the Information label on the back of the DCX S Power Supply . . . . .39



---

# List of Tables

---

**Chapter 1: Safety and Support****Chapter 2: Introduction****Chapter 3: Connecting to the Web Page Interface****Chapter 4: The Web Page Interface**

|            |  |    |
|------------|--|----|
| Table 4.1  | Web Page Interface Overview . . . . .        | 18 |
| Table 4.2  | IP Setup Menu Option . . . . .               | 20 |
| Table 4.3  | Weld Preset Menu Option . . . . .            | 22 |
| Table 4.4  | I/O Diagnostics Menu Option . . . . .        | 24 |
| Table 4.5  | Seek & Weld Graphs Menu Option . . . . .     | 27 |
| Table 4.6  | Horn Signature Menu Option. . . . .          | 29 |
| Table 4.7  | System Information Menu Option . . . . .     | 30 |
| Table 4.8  | Available Digital Input Functions . . . . .  | 32 |
| Table 4.9  | Available Digital Output Functions . . . . . | 32 |
| Table 4.10 | Available Analog Input Functions. . . . .    | 33 |
| Table 4.11 | Available Analog Output Functions. . . . .   | 33 |
| Table 4.12 | Alarm Log Menu Option . . . . .              | 34 |

**Appendix A: Manual's Revisions**

|           |                              |    |
|-----------|------------------------------|----|
| Table A.1 | Manual's Revisions . . . . . | 38 |
|-----------|------------------------------|----|



---

# **Chapter 1: Safety and Support**

---





**1.1 Safety Requirements and Warnings ..... 2**  
**1.2 General Precautions ..... 4**  
**1.3 How to Contact Branson ..... 6**



## 1.1 Safety Requirements and Warnings

This chapter contains an explanation of the different safety notice symbols and icons found in this manual and provides additional safety information for ultrasonic welding. This chapter also describes how to contact Branson for assistance.

### 1.1.1 Symbols Found in this Manual

Three symbols used throughout this manual warrant special attention:

|   |  |
|---|--|
| <b>WARNING</b>  | <b>General Warning</b>   |
|    | <b>WARNING</b> indicates a hazardous situation or practice which, if not avoided, can result in serious injury or death.   |
| <b>WARNING</b>  | <b>High Voltage Hazard</b>   |
|   | High voltage. Turn power off before servicing.   |
| <b>WARNING</b>  | <b>Corrosive Material Hazard</b>   |
|  | Corrosive material. Avoid contact with eyes and skin. Wear proper protection.  |
| <b>CAUTION</b>  | <b>General Warning</b>   |
|  | <b>CAUTION</b> indicates a hazardous situation which, if not avoided, could result in minor or moderate injury. It can also alert the user to unsafe practices or conditions that can damage equipment if not corrected. |

| CAUTION  | Loud Noise Hazard   |
|--|---|
|   | Loud noise hazard. Ear protection must be worn.   |
| CAUTION  | Heavy Object  |
|   | Heavy object. To avoid muscle strain or back injury, use lifting aids and proper lifting techniques.  |
| NOTICE   |   |
|  | <b>NOTICE</b> contains important information. It does not alert the user to potential injury, but only to a situation that might eventually require additional work or modification if you ignore it initially. |

## 1.2 General Precautions

Take the following precautions before servicing the power supply:

- Be sure the power is disconnected before making any electrical connections
- To prevent the possibility of an electrical shock, always plug the power supply into a grounded power source
- Power supplies produce high voltage. Before working on the power supply assembly, do the following:
  - Turn off the power supply
  - Unplug main power
  - Allow at least 5 minutes for capacitors to discharge
- High voltage is present in the power supply. Do not operate with the cover removed
- High line voltages exist in the ultrasonic power supply assembly. Common points are tied to circuit reference, not chassis ground. Therefore, use only non-grounded, battery-powered multimeters when testing the power supply assembly. Using other types of test equipment can present a shock hazard
- Keep hands from under the horn. Down force (pressure) and ultrasonic vibrations can cause injury
- Do not cycle the welding system if either the RF cable or converter is disconnected
- When using larger horns, avoid situations where fingers could be pinched between the horn and the fixture

| CAUTION   | Loud Noise Hazard  |
|---|--|
|  | <p>Sound level and frequency of the noise emitted during the ultrasonic assembly process may depend upon <b>a.</b> type of application, <b>b.</b> size, shape and composition of the material being assembled, <b>c.</b> shape and material of the holding fixture, <b>d.</b> welder setup parameters and <b>e.</b> tool design.</p> <p>Some parts vibrate at an audible frequency during the process. Some or all of these factors may result in an uncomfortable noise being emitted during the process.</p> <p>In such cases operators may need to be provided with personal protective equipment. See 29 CFR (Code of Federal Regulations) 1910.95 Occupational Noise Exposure</p> |

| NOTICE  |   |
|---|---|
|  | <p>When the battery is worn out, dispose it under the ordinance of each local government.</p> |

| WARNING   | Corrosive Material Hazard  |
|---|--|
|  | <p>First aid measures (in case of electrolyte leakage from the battery)</p> <p><b>Eye Contact:</b> Flush the eyes with plenty of clean water for at least 15 minutes immediately, without rubbing. Get immediate medical treatment. If appropriate procedures are not taken, this may cause eye injury.</p> <p><b>Skin Contact:</b> Wash the affected area under tepid running water using a mild soap. If appropriate procedures are not taken, this may cause sores on the skin. Get medical attention if irritation develops or persists.</p> <p><b>Inhalation:</b> Remove to fresh air immediately. Get medical treatment immediately.</p> |

### 1.2.1 Intended Use of the System

The DCX Power Supply and components are designed to be used as part of an ultrasonic welding system. These are designed for a wide variety of welding or processing applications.

The system can be used to perform ultrasonic welding, inserting, staking, spot welding, swaging, degating, and continuous ultrasonic operations. It is designed for automated, semi-automated and/or manual production operations.

### 1.2.2 Emissions

When being processed, certain plastic materials can emit toxic fumes, gases or other emissions that can be hazardous to the operator's health. Where such materials are processed, proper ventilation of the workstation is required. Check your materials suppliers for recommended protection when processing their materials.

| WARNING   | Corrosive Material Hazard  |
|---|--|
|  | <p>Processing of many materials, such as PVC, can be hazardous to an operator's health and could cause corrosion/damage to the equipment. Use proper ventilation and take protective measures.</p> |

## **1.3 How to Contact Branson**

For additional assistance, please refer to the DCX S Power Supply Instruction Manual.

---

## **Chapter 2: Introduction**

---

|            |                             |          |
|------------|-----------------------------|----------|
| <b>2.1</b> | <b>Introduction</b> .....   | <b>8</b> |
| <b>2.2</b> | <b>Models Covered</b> ..... | <b>9</b> |

## 2.1 Introduction

The DCX S Web Page Interface provides access, via Ethernet connection, to web pages containing power supply information, diagnostics tools, and configuration options. Communication can be established point-to-point or through a local area network. On the web page interface you can access:

- [4.3 IP Setup](#)
- [4.4 Weld Preset](#)
- [4.5 I/O Diagnostics](#)
- [4.6 Seek & Weld Graphs](#)
- [4.7 Horn Signature](#)
- [4.8 System Information](#)
- [4.9 I/O Configuration](#)
- [4.10 Alarm Log](#)

## **2.2 Models Covered**

This manual applies to the web page interface of the DCX S power supply.

### **2.2.1 DCX S Power Supply Manual Set**

The following documentation is available in electronic format for the DCX S power supply:

- DCX S Power Supply Instruction Manual



---

## **Chapter 3: Connecting to the Web Page Interface**

---

|            |   |           |
|------------|---|-----------|
| <b>3.1</b> | <b>Locating the Ethernet Port</b> .....                             | <b>12</b> |
| <b>3.2</b> | <b>System Requirements</b> .....                                    | <b>13</b> |
| <b>3.3</b> | <b>Point to Point Connection (Windows 10® or Windows 11®)</b> ..... | <b>14</b> |

## 3.1 Locating the Ethernet Port

### 3.1.1 DCX S Ethernet Port Location

Figure 3.1 DCX S Power Supply



## 3.2 System Requirements

To connect to the DCX Web Page Interface you will need a PC running a Windows<sup>®1</sup> operating system with a Google Chrome<sup>™ 2</sup> or Microsoft Edge<sup>®1</sup> web browser software.

| NOTICE  |  |
|---|--|
|  | The DCX S power supply is not compatible with network scanning software. If your local network uses these types of programs, the DCX S IP address must be placed in an exclusion list. |

| NOTICE  |  |
|---|--|
|  | A shielded Ethernet cable should be used to connect to the DCX S Web Page Interface to prevent possible EMI (Electromagnetic Interference) issues. |

---

1. Windows 10, Windows 11, and Microsoft Edge are registered trademarks of Microsoft Corporation.  
2. Google Chrome is a trademark of Google LLC.

## 3.3 Point to Point Connection (Windows 10® or Windows 11®)

To connect directly to the DCX S Web Page Interface using a PC with Windows 10<sup>®1</sup> or Windows 11<sup>®1</sup> operating system, complete the following steps:

1. Connect the power supply to a computer via the Ethernet port
2. Turn on the power supply
3. On your PC, click the Start button on the taskbar and search for the **Control Panel**
4. Select **View Large Icons** on the top right corner
5. Select **Network and Sharing Center**
6. Select **Change adapter settings**

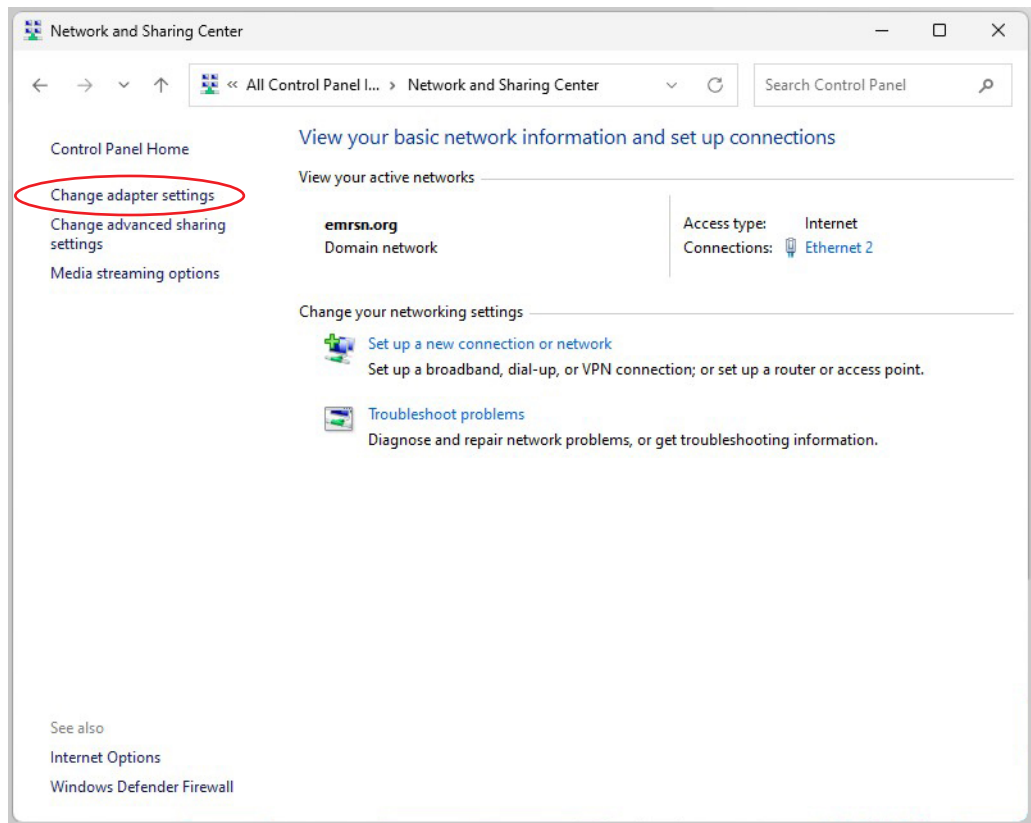

7. Right click on **Ethernet 2** and select **Properties** to bring up the **Networking** tab

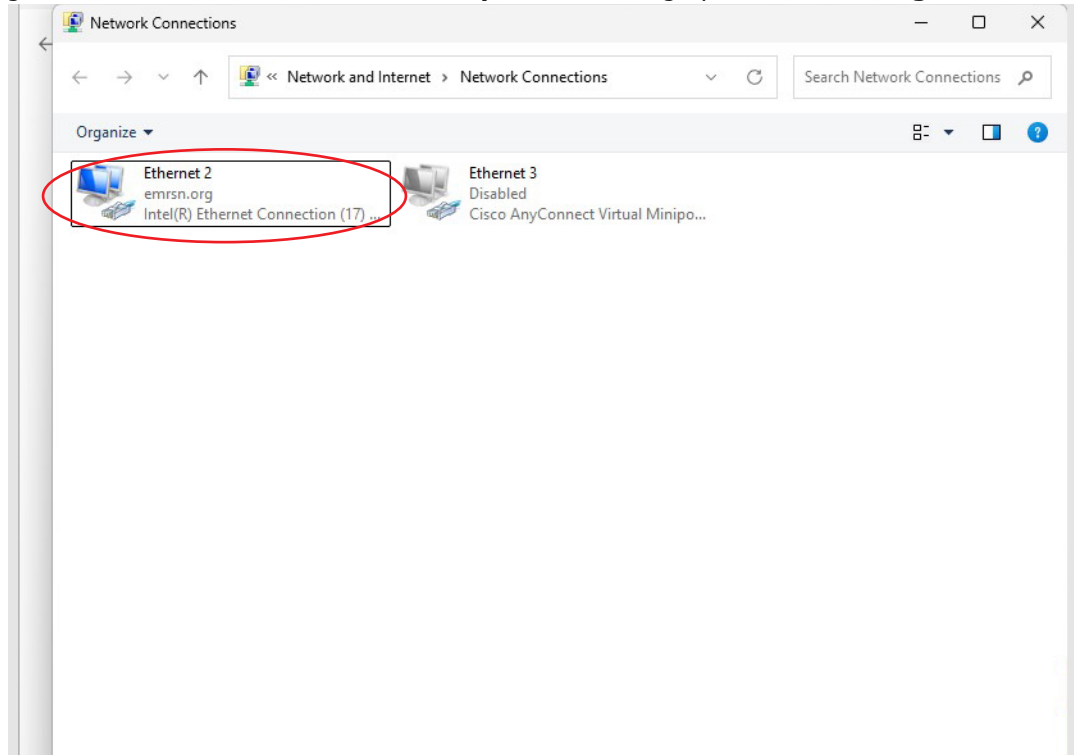

8. Highlight Internet Protocol Version 4 (TCP/IPv4) from the list and click on Properties

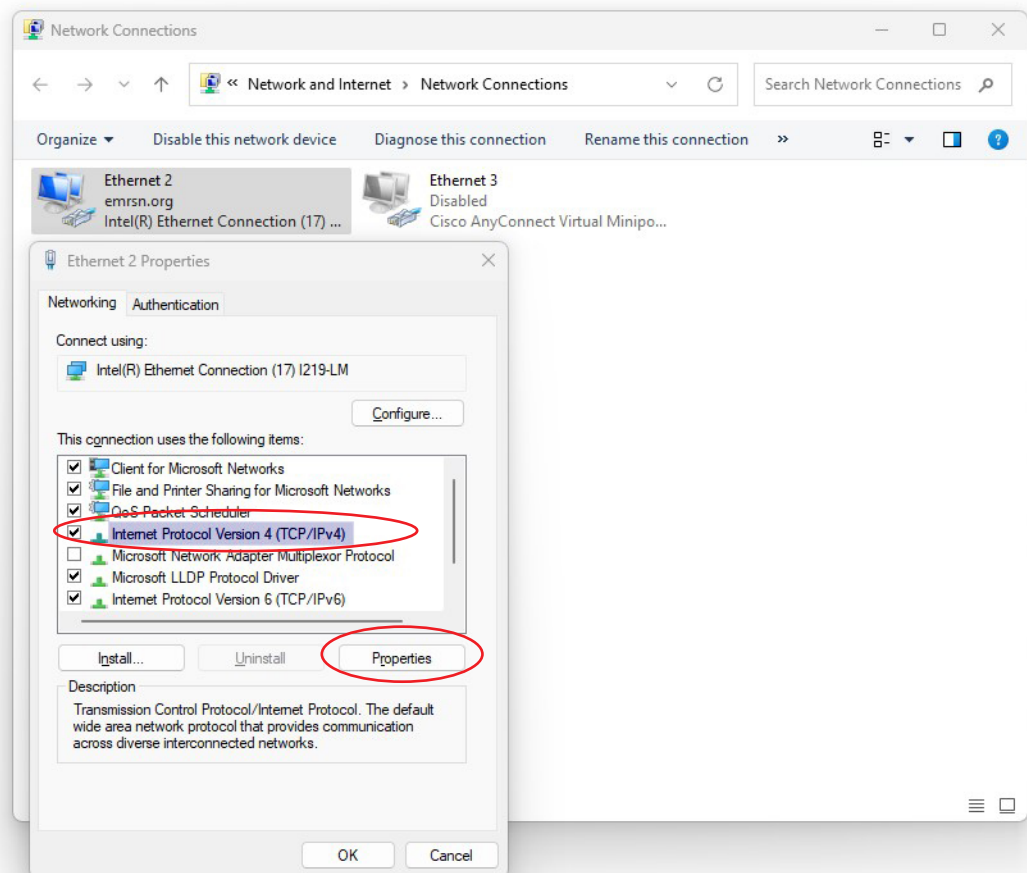

9. Use the following IP address:

**IP address:** 192.168.10.101

**Subnet mask:** 255.255.255.0

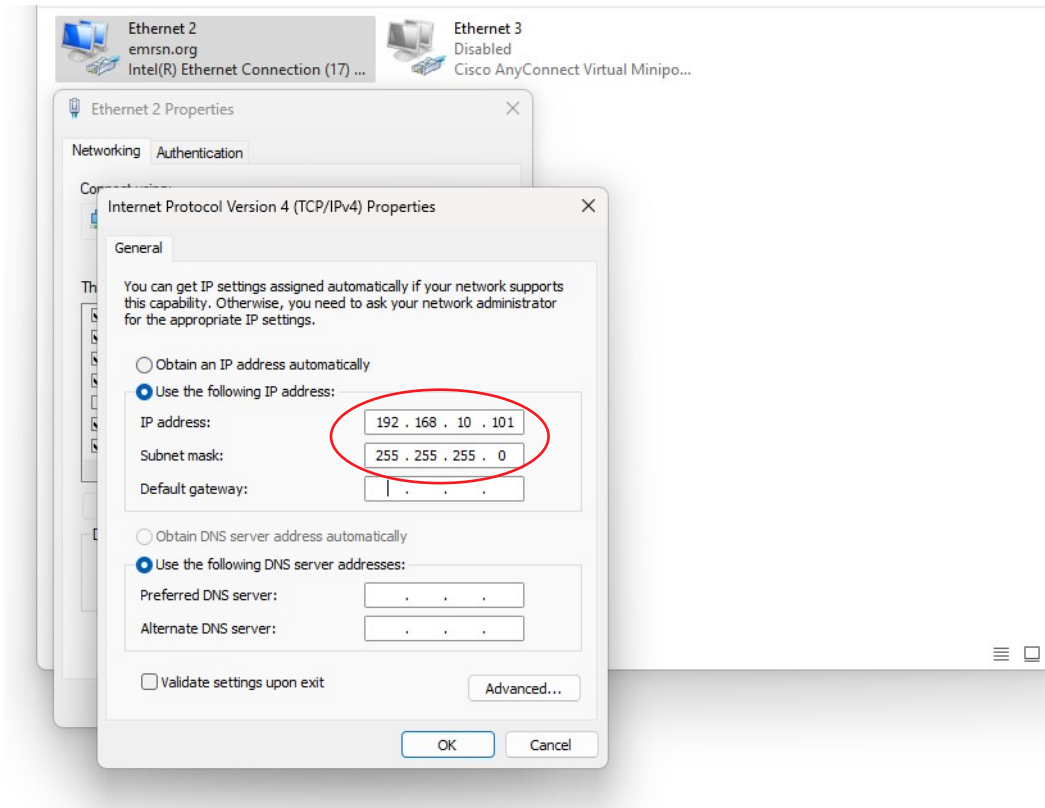

10. Click OK. Close the rest of the dialog boxes

11. Open the Google Chrome™ or Microsoft Edge® web browser

12. In the address bar type the following address: <http://192.168.10.100>. Press Enter

13. This will bring up the DCX S Web Page Interface

14. Enter a user ID number (any number up to 9 digits long)

---

## **Chapter 4: The Web Page Interface**

---

|             |  |           |
|-------------|--|-----------|
| <b>4.1</b>  | <b>Web Page Interface Overview</b> . . . . . | <b>18</b> |
| <b>4.2</b>  | <b>Login</b> . . . . .                       | <b>19</b> |
| <b>4.3</b>  | <b>IP Setup</b> . . . . .                    | <b>20</b> |
| <b>4.4</b>  | <b>Weld Preset</b> . . . . .                 | <b>22</b> |
| <b>4.5</b>  | <b>I/O Diagnostics</b> . . . . .             | <b>24</b> |
| <b>4.6</b>  | <b>Seek &amp; Weld Graphs</b> . . . . .      | <b>26</b> |
| <b>4.7</b>  | <b>Horn Signature</b> . . . . .              | <b>28</b> |
| <b>4.8</b>  | <b>System Information</b> . . . . .          | <b>30</b> |
| <b>4.9</b>  | <b>I/O Configuration</b> . . . . .           | <b>31</b> |
| <b>4.10</b> | <b>Alarm Log</b> . . . . .                   | <b>34</b> |

## 4.1 Web Page Interface Overview

The DCX S Web Page Interface allows you to set a weld preset, diagnose and configure the power supply I/O, perform horn scans and seeks, view system information, and to view and download the system alarms, history and events logs.

**Figure 4.1** Web Page Interface Overview

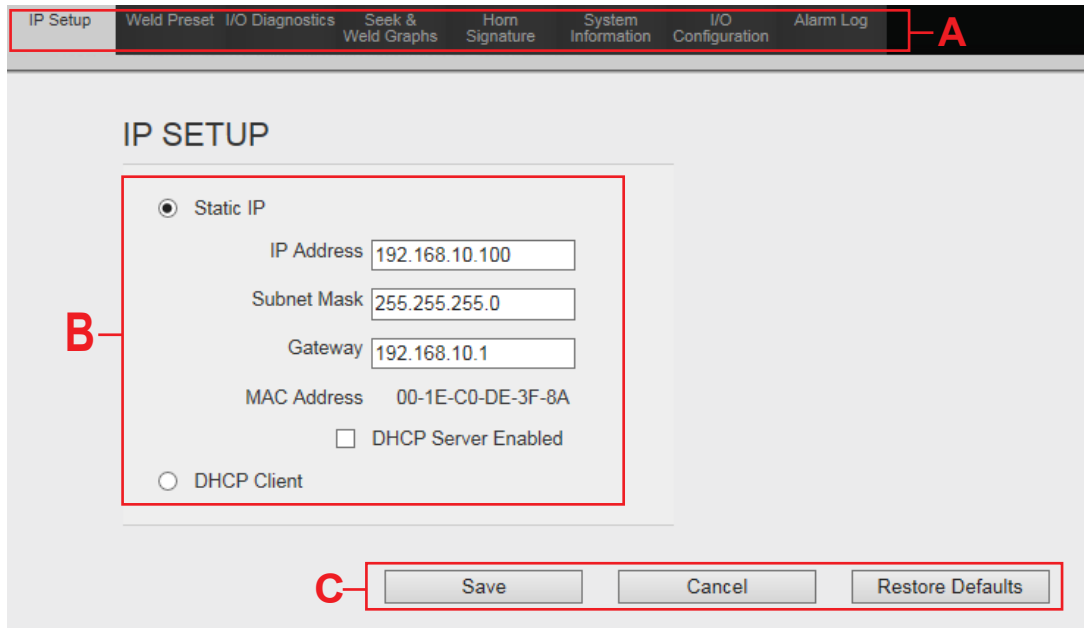

**Table 4.1** Web Page Interface Overview

| Item | Name                 | Description  |
|------|----------------------|--|
| A    | Menu Navigation Tabs | The menu navigation tabs are always displayed on the upper section of the web pages. They provide access to the following menu options:<br><a href="#">4.3 IP Setup</a><br><a href="#">4.4 Weld Preset</a><br><a href="#">4.5 I/O Diagnostics</a><br><a href="#">4.6 Seek &amp; Weld Graphs</a><br><a href="#">4.7 Horn Signature</a><br><a href="#">4.8 System Information</a><br><a href="#">4.9 I/O Configuration</a><br><a href="#">4.10 Alarm Log</a> |
| B    | Menu Display         | Displays the contents of the currently selected menu option.   |
| C    | Command Buttons      | Different command buttons allow to save settings, cancel changes, restore default settings, and to perform other functions specific to each menu.<br><br>Save, Cancel, and Restore Defaults is page specific. They only operate on the page displayed.   |

## 4.2 Login

When connection is established with the DCX S Web Page Interface, the Login page will display. Enter a unique user ID number. The user ID is numeric only and up to 9 digits long. This number allows for keeping track of user access.

**Figure 4.2** Login

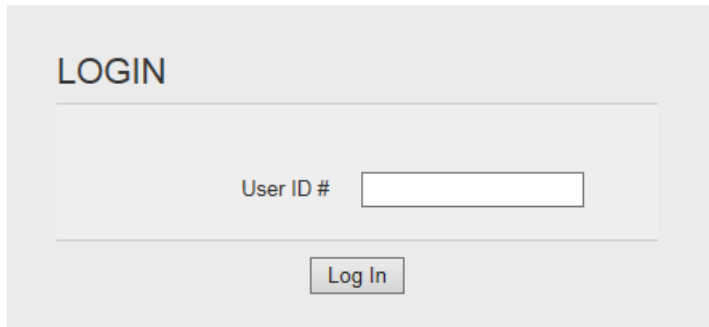

The image shows a web interface for logging in. At the top left, the word "LOGIN" is displayed in a large, bold, sans-serif font. Below this, there is a horizontal line. Underneath the line, the text "User ID #" is positioned to the left of a rectangular text input field. Below the input field, there is another horizontal line. At the bottom center, there is a rectangular button with the text "Log In" inside it.

## 4.3 IP Setup

Use this menu to setup the DCX S power supply's network settings. DCX S power supply's default IP setting is Static IP with the address shown in the figure below.

**Figure 4.3** IP Setup Menu

**Table 4.2** IP Setup Menu Option

| Name                | Description  |
|---------------------|--|
| <b>IP SETUP</b>     |  |
| Static IP           | Select this option to manually assign an IP address to the DCX S power supply. The DCX S power supply will alert if an invalid IP address setting is entered.  |
| IP Address          | The IP address assigned to the DCX S power supply.   |
| Subnet Mask         | The mask used to determine to what subnet the DCX S power supply's address belongs to.   |
| Gateway             | The gateway address assigned to the network for communication with other computers or networks.  |
| MAC Address         | Displays the MAC address assigned to the DCX S power supply.   |
| DHCP Server Enabled | Select this option to have DCX S power supply assign IP addresses to any devices connected to it. This facilitates connecting a computer or laptop point to point (P2P) with the DCX S power supply.<br><br><b>NOTICE</b><br>Connecting a DCX S power supply with DHCP server enabled to a network which already has a device working as a DHCP server will cause connectivity problems. |

**Table 4.2** IP Setup Menu Option

| Name        | Description  |
|-------------|--|
| DHCP Client | Select this option to have the DCX S power supply automatically request an IP address from a DHCP Server. The IP address will be grayed out. |

| NOTICE  |  |
|---|--|
|  | All changes on this menu take effect on the next power-up. |

At any time you may determine the DCX S power supply's IP address by going through the associated registers using the front panel LCD. A Cold Start can also be performed to take your power supply back to its factory default IP address. For details on navigating the DCX S registers or performing a Cold Start, consult your power supply manual.

| NOTICE  |  |
|---|--|
|  | Beware that other settings will also be reset to their defaults when a Cold Start is executed. |

## 4.4 Weld Preset

Use this menu to set weld parameters, seek options, and power-up actions. Use the command buttons on the bottom to save settings, cancel changes, or to restore to factory default settings.

**Figure 4.4** Weld Preset Menu

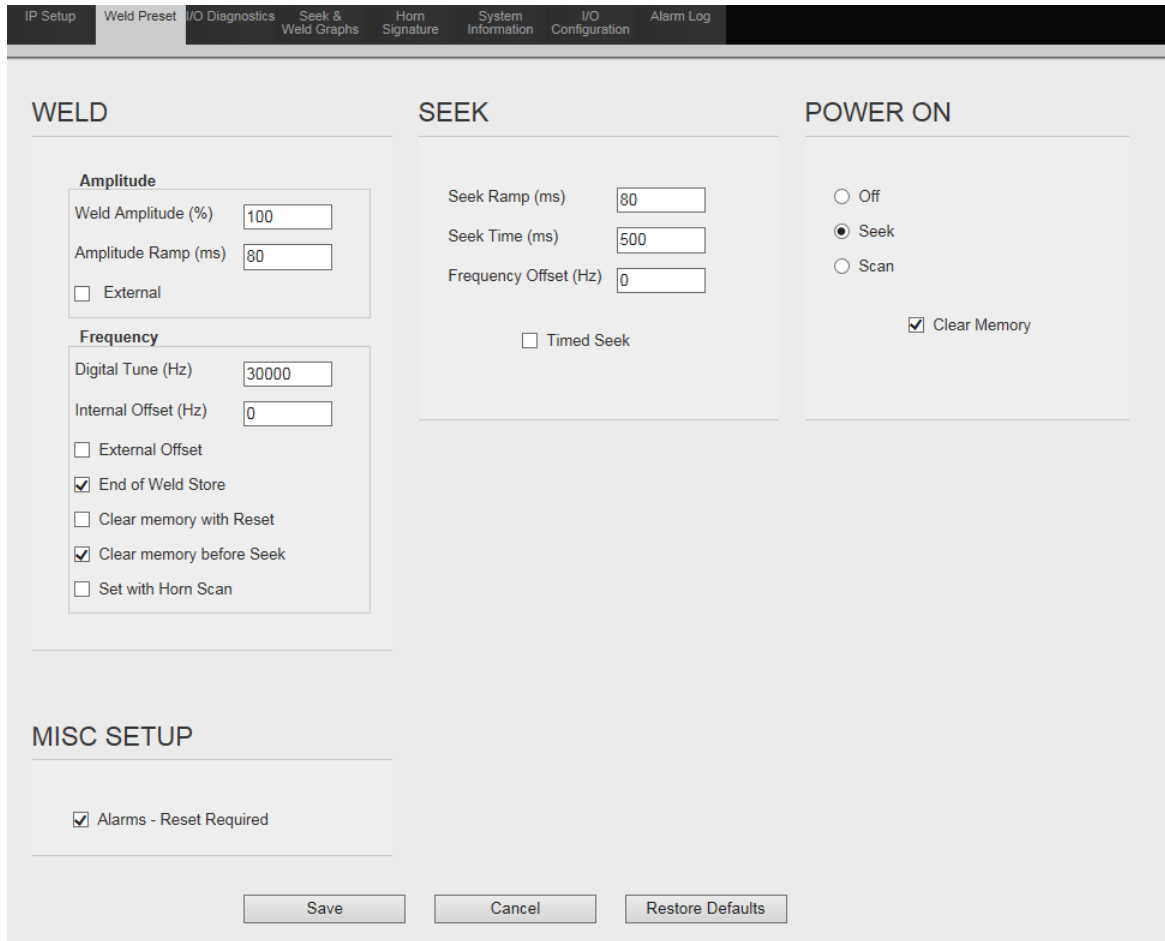

**Table 4.3** Weld Preset Menu Option

| Name                | Description  |
|---------------------|--|
| <b>Amplitude</b>    |  |
| Weld Amplitude (%)  | The amplitude of ultrasonic energy that will be delivered by the DCX S power supply. Valid range is between 10 to 100 (10% to 100% amplitude).                                     |
| Amplitude Ramp (ms) | The time it takes for the amplitude to ramp up to 100% when the External Start signal is applied. If amplitude setting is lower than 100%, ramp time will be adjusted accordingly. |
| External            | Select the External check box to control the amplitude using an analog input from the user I/O connector.  |

**Table 4.3** Weld Preset Menu Option

| Name                     | Description  |
|--------------------------|--|
| <b>Frequency</b>         |  |
| Digital Tune (Hz)        | Starting frequency set from horn signature or manually entered.  |
| Internal Offset (Hz)     | Sets the frequency offset from the Web Page as either a positive or negative value offset from digital tune.   |
| External Offset          | Select the External Offset check box to control the frequency offset using an analog input from the user I/O connector (J3).   |
| End of Weld Store        | Select to save the frequency at the end of the weld as the starting frequency for the following weld.  |
| Clear memory with Reset  | Select to clear memory with reset. Memory offset will be set to 0 when a Reset is applied. Reset can come from external I/O, front panel, or web page interface (seek or horn scan). |
| Clear Memory before Seek | Select to clear memory before seek. Memory offset will be set to 0 before Seek is applied.   |
| Set with Horn Scan       | Select to set Digital Tune frequency with a successfully completed horn scan.  |
| <b>Seek</b>              |  |
| Seek Ramp (ms)           | The time it will take the power supply to ramp-up when performing a seek.  |
| Seek Time (ms)           | The duration of a seek.  |
| Frequency Offset (Hz)    | The frequency offset applied to the power supply operating frequency.  |
| Timed Seek               | Select this check box to have the power supply perform a seek every 60 seconds. Seeks will be timed from the moment sonics was last activated.                                       |
| <b>Power On</b>          |  |
| Off                      | Select this option to disable power-on actions.  |
| Seek                     | Select this option to have the power supply perform a seek on power-up.  |
| Scan                     | Select this option to have the power supply perform a horn scan on power-up.   |
| <b>Misc Setup</b>        |  |
| Alarms - Reset Required  | This option determines if the alarm is latched or not. Latched alarms require a reset before another cycle can start.  |

## 4.5 I/O Diagnostics

Use this menu to monitor and control the DCX S power supply digital and analog I/O.

**Figure 4.5** I/O Diagnostics Menu

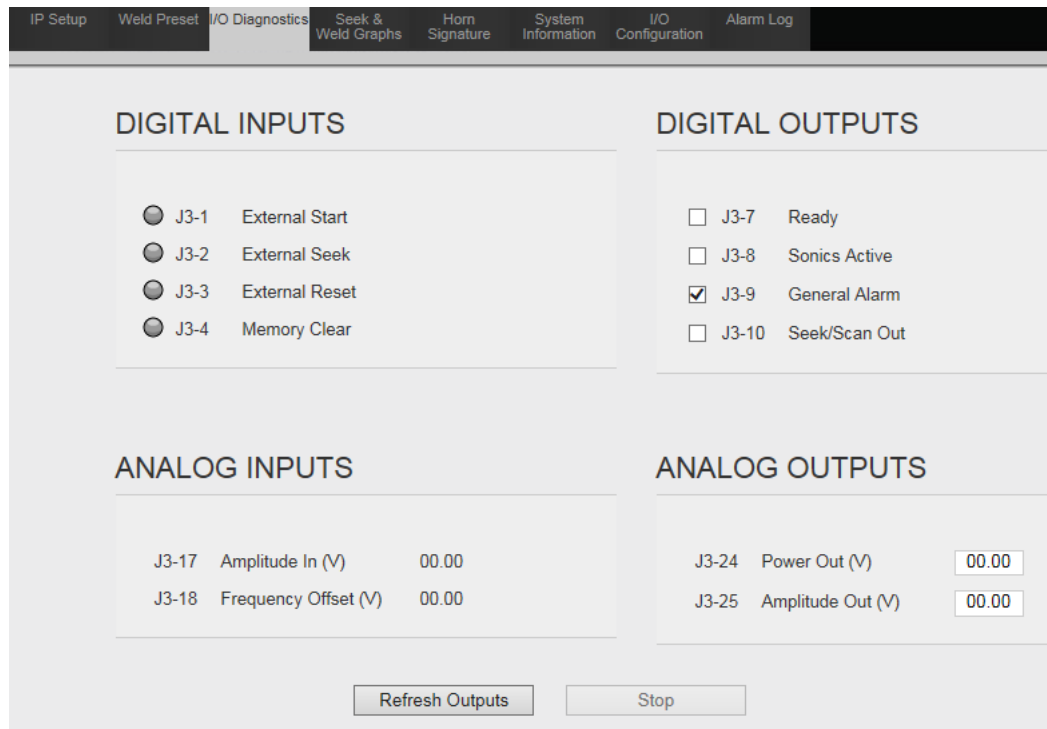

**Table 4.4** I/O Diagnostics Menu Option

| Name                       | Description  |
|----------------------------|--|
| <b>Digital Inputs</b>      |  |
| J3-1 External Start        | Indicate if the digital inputs are active.                           |
| J3-2 External Seek         |  |
| J3-3 External Reset        |  |
| J3-4 Memory Clear          |  |
| <b>Digital Outputs</b>     |  |
| J3-7 Ready                 | Select/clear check boxes to toggle available digital outputs on/off. |
| J3-8 Sonics Active         |  |
| J3-9 General Alarm         |  |
| J3-10 Seek/Scan Out        |  |
| <b>Analog Inputs</b>       |  |
| J3-17 Amplitude In (V)     | Displays the current analog input values.                            |
| J3-18 Frequency Offset (V) |  |

**Table 4.4** I/O Diagnostics Menu Option

| Name                    | Description                             |
|-------------------------|---|
| <b>Analog Outputs</b>   |   |
| J3-24 Power Out (V)     | Allows control of analog output values. |
| J3-25 Amplitude Out (V) |   |

## 4.6 Seek & Weld Graphs

Use this menu to test your system. This feature allows you to capture 5 seconds of welding data which you can both view and export. The weld data graph is provided with 6 available parameters: Amplitude, Power, Phase, PWM Amplitude, Current, and Frequency. Each parameter has a checkbox to the left of its name.

Only checked parameters will be displayed. While in this menu, if the Weld is being run from external I/O or the custom LCD, the graph can be also displayed on the screen by using the "Update Graph" button.

**Figure 4.6** Seek & Weld Graphs Menu



**Table 4.5** Seek & Weld Graphs Menu Option

| Name               | Description  |
|--------------------|--|
| <b>Seek</b>        |  |
| Seek               | Click to perform a seek cycle.   |
| Reset Overload     | Click to reset an overload condition.  |
| OK - Memory Stored | Indicates that the horn operating frequency was stored in the DCX S power supply memory.   |
| Overload - Cleared | Indicates that test resulted in an overload and the memory has been cleared.   |
| Frequency          | Monitors the horn operating frequency.   |
| Memory             | Displays the frequency stored in the DCX S power supply memory.  |
| Amplitude          | Displays the percentage of converter amplitude.  |
| Power              | Displays the percentage of power output.   |
| Update Graph       | Click to get the value of all the parameter and draw the graph for Phase, Current, Amplitude, Power, and Frequency parameters vs Time on the Y axis. |
| Export Graph Data  | Click to export the Weld Graph data with Weld Preset settings to CSV file.   |
| Draw from... to... | Select the <i>from</i> and <i>to</i> time values to zoom into the desired graph region.  |
| Redraw Graph       | Click to redraw the same graph with those parameters which are checked with the Time parameter on Y axis.  |
| Set Default        | Click to return the sample rate, start time, end time and graph selection to default settings.   |
| Graph Selection    | Select a parameter and enter a particular X time value to obtain the corresponding Y value at that particular time.                                  |
| Update Value       | Click to update the Y value.   |

## 4.7 Horn Signature

Use this menu to diagnose your ultrasonic horn. When performing a horn scan, ideally, there will be only one resonant frequency. The Horn Signature graph is provided with 3 available parameters: Phase, Current, and Amplitude. The horn Signature Graph can be both viewed and exported.

Each parameter has a checkbox to the left of its name. Only checked parameters will be displayed.

**Figure 4.7** Horn Signature Menu

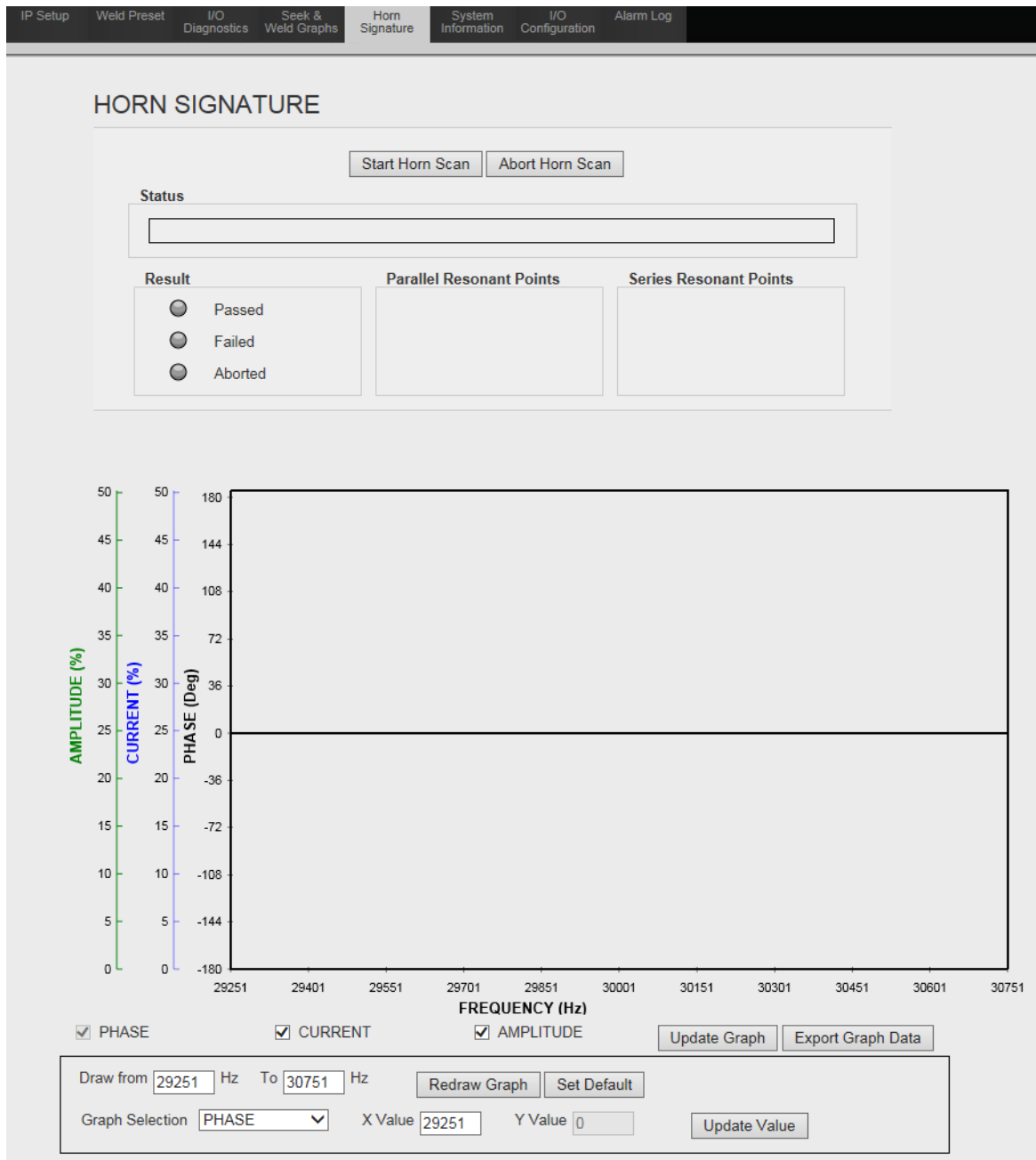

**Table 4.6** Horn Signature Menu Option

| Name                     | Description   |
|--------------------------|---|
| <b>Horn Signature</b>    |   |
| Start Horn Scan          | Click to initiate the horn scan.  |
| Abort Horn Scan          | Click to abort the horn scan.   |
| Status                   | Indicates the horn scan progress.   |
| Result                   | Indicates if the horn scan passed, failed, or if the operation was aborted.   |
| Parallel Resonant Points | <p>Displays the parallel resonant frequencies of the ultrasonic horn. The parallel resonant frequency is the operating frequency of the ultrasonic stack.</p> <p><b>NOTICE</b><br/>If multiple parallel frequencies are found, they will all be listed. The frequency at which the ultrasonic stack is running will be displayed in blue.</p> |
| Series Resonant Points   | Displays the series resonant frequencies of the ultrasonic horn.  |
| Update Graph             | Click to get the value of all the parameter and draw the graph for Phase, Current, Amplitude, Power, and Frequency parameters vs Time on the Y axis.  |
| Export Graph Data        | Click to export the Weld Graph data with Weld Preset settings to CSV file.  |
| Draw from... to...       | Select the <i>from</i> and <i>to</i> time values to zoom into the desired graph region.   |
| Redraw Graph             | Click to redraw the same graph with those parameters which are checked with the Time parameter on Y axis.   |
| Set Default              | Click to return the sample rate, start time, end time and graph selection to default settings.  |
| Graph Selection          | Select a parameter and enter a particular X time value to obtain the corresponding Y value at that particular time.   |
| Update Value             | Click to update the Y value.  |

## 4.8 System Information

Use this menu to view information about your DCX S power supply. Have the information on this screen available when calling Branson for troubleshooting help.

**Figure 4.8** System Information Menu

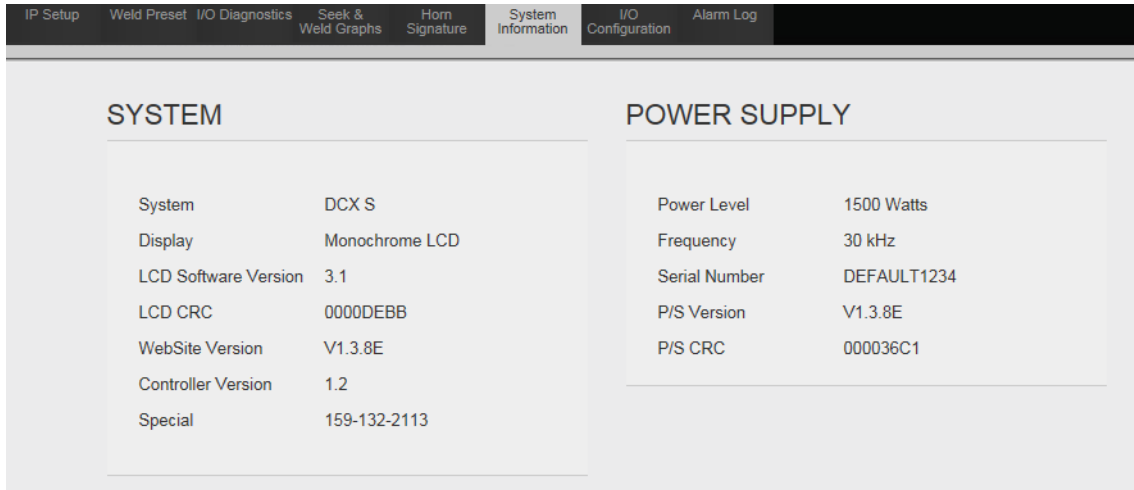

**Table 4.7** System Information Menu Option

| Name                 | Description  |
|----------------------|--|
| <b>System</b>        |  |
| System               | Displays the DCX S power supply model name.                                |
| Display              | Displays the type of front panel user interface on the DCX S power supply. |
| LCD Software Version | Displays the LCD software version number.                                  |
| LCD CRC              | Displays the CRC code of the LCD software.                                 |
| WebSite Version      | Displays the Web Page version number.                                      |
| Controller Version   | Displays the controller version.   |
| <b>Power Supply</b>  |  |
| Power Level          | Displays the power supply wattage.   |
| Frequency            | Displays the power supply operating frequency.                             |
| Serial Number        | Displays the power supply serial number.                                   |
| P/S Version          | Displays the power supply software version number.                         |
| CRC                  | Displays the CRC code of the power supply controller software.             |

## 4.9 I/O Configuration

Use this menu to configure the DCX S power supply I/O according to your specific interfacing needs. Use the command buttons on the bottom to save settings, cancel changes, or to restore to factory default settings.

| CAUTION   |   |
|---|---|
|  | <p>When using 0 V to activate ultrasonics (External Start signal), it is recommended to assign one input as Cable Detect to prevent sonics from activating if 24 V is lost by accident.</p> |

**Figure 4.9** I/O Configuration Menu

IP Setup
Weld Preset
I/O Diagnostics
Seek & Weld Graphs
Hom Signature
System Information
I/O Configuration
Alarm Log

### DIGITAL INPUTS

J3 - 1

 External Start  0 V  24 V

J3 - 2

 External Seek  0 V  24 V

J3 - 3

 External Reset  0 V  24 V

J3 - 4

 Memory Clear  0 V  24 V

### DIGITAL OUTPUTS

J3 - 7

 Ready  0 V  24 V

J3 - 8

 Sonics Active  0 V  24 V

J3 - 9

 General Alarm  0 V  24 V

J3 - 10

 Seek/Scan Out  0 V  24 V

### ANALOG INPUTS

J3 - 17

 Amplitude In

J3 - 18

 Frequency Offset

### ANALOG OUTPUTS

J3 - 24

 Power Out

J3 - 25

 Amplitude Out

## 4.9.1 Available Digital Input Functions

**Table 4.8** Available Digital Input Functions

| Function           | Description   |
|--------------------|---|
| Cable Detect       | Disables ultrasonics if 24 V signal is removed when using 0 V negative logic (active low) for the external Start input. Used to prevent ultrasonics from coming on if a cable is removed.   |
| Display Lock       | Locks the front panel display controls.   |
| External Horn Scan | Starts horn scan sequence.  |
| External Reset     | Resets alarm conditions.  |
| External Seek      | Activates ultrasonic energy at 10% amplitude for the purpose of finding the ultrasonic stack resonant frequency.  |
| External Start     | Activates ultrasonic energy at the currently set amplitude.<br><div style="background-color: #003366; color: white; padding: 2px; display: inline-block; margin-bottom: 5px;"><b>NOTICE</b></div> DCX S power supply must be in ready mode before External Start. |
| External Test      | Performs a test cycle.  |
| Memory Clear       | Centers the power supply start frequency.   |

## 4.9.2 Available Digital Output Functions

**Table 4.9** Available Digital Output Functions

| Function       | Description  |
|----------------|--|
| General Alarm  | Indicates an alarm occurred.                           |
| Overload Alarm | Indicates an overload alarm has occurred.              |
| Ready          | Indicates the system is ready.                         |
| Seek/Scan Out  | Indicates either a seek or a horn scan is in progress. |
| Sonics Active  | Indicates sonics are active.                           |

### 4.9.3 Available Analog Input Functions

**Table 4.10** Available Analog Input Functions

| Function         | Description   |              |
|------------------|---|--------------|
| Amplitude In     | Controls the amplitude of ultrasonic energy that will be delivered by the power supply.   |              |
| Frequency Offset | Controls the frequency offset to the power supply operating frequency. Actual offset depends on the power supply operating frequency: |              |
|                  | Frequency   | Offset Range |
|                  | 20 kHz  | ±400 Hz      |
|                  | 30 kHz  | ±600 Hz      |
| 40 kHz           | ±800 Hz   |              |

### 4.9.4 Available Analog Output Functions

**Table 4.11** Available Analog Output Functions

| Function      | Description   |                   |                    |
|---------------|---|-------------------|--------------------|
| Amplitude Out | Provides a 0 V to 10 V output signal proportional to amplitude (0% to 100%).  |                   |                    |
| Power Out     | Provides a 0 V to 10 V output signal proportional to ultrasonic power output (0% to 100%).  |                   |                    |
| Frequency Out | Provides a 0 V to 10 V output signal that indicates relative frequency in memory. Actual frequency depends on the power supply operating frequency: |                   |                    |
|               | Frequency   | Lower Limit (0 V) | Upper Limit (10 V) |
|               | 20 kHz  | 19,450 Hz         | 20,450 Hz          |
|               | 30 kHz  | 29,250 Hz         | 30,750 Hz          |
| 40 kHz        | 38,900 Hz   | 40,900 Hz         |                    |

## 4.10 Alarm Log

Use this screen to view the DCX S power supply alarm history. The alarms can be sorted by alarm number or alarm type. Alarms can be exported to an Excel file.

| NOTICE  |  |
|---|--|
|  | Only the last 100 alarms are stored in memory. |

**Figure 4.10** Alarm Log Menu

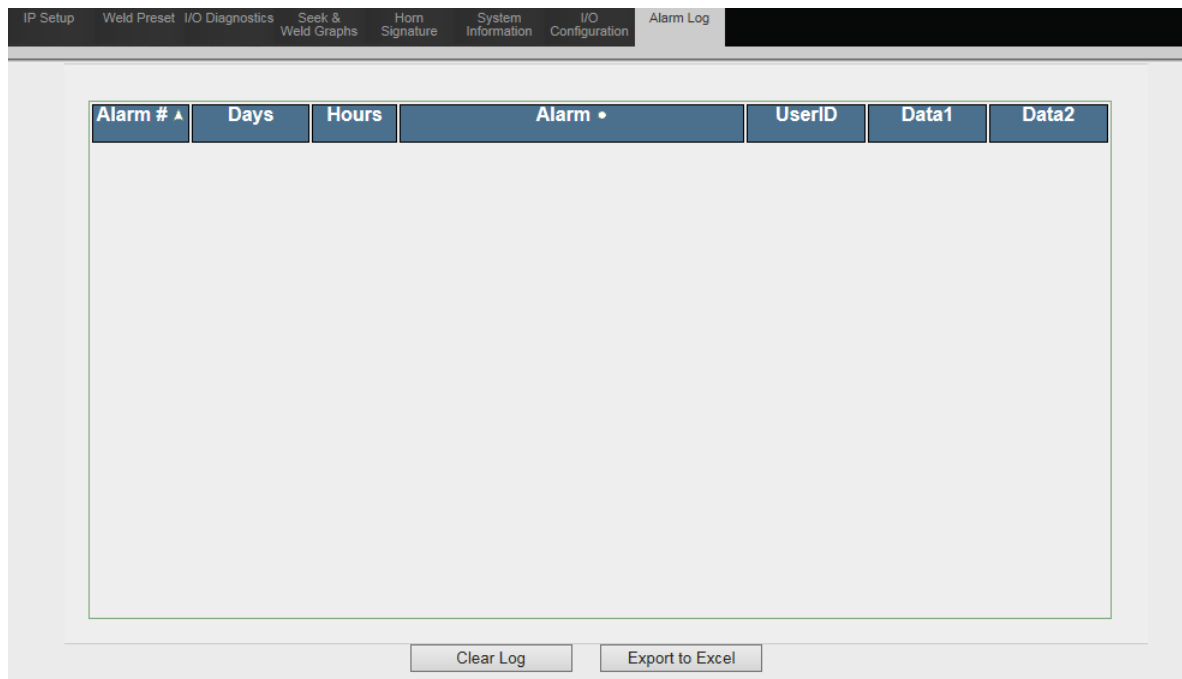

**Table 4.12** Alarm Log Menu Option

| Name    | Description   |
|---------|---|
| Alarm # | A unique alarm identification number.   |
| Days    | The DCX S power supply units do not feature an integrated real time clock. Alarm date and time account for the power-on hours from the moment the DCX S power supply was first turned on. |
| Hours   |   |
| Alarm   | Displays a brief alarm description.   |
| UserID  | The ID number of the user logged in at when the alarm occurred. Will display zero if the alarm occurs from an external weld.  |

**Table 4.12** Alarm Log Menu Option

| <b>Name</b>            | <b>Description</b>  |
|------------------------|---|
| Data1                  | For future use.   |
| Data2                  |   |
| <b>Command Buttons</b> |   |
| Clear Log              | Click to clear the alarm log.                                 |
| Export to Excel        | Click to download an Excel spreadsheet file of the alarm log. |



---

## **Appendix A: Manual's Revisions**

---

**A.1 Manual's Revisions ..... 38**

## A.1 Manual's Revisions

Refer to the table below for the appropriate manual revision depending on your Power Supply's manufacturing date.

**Table A.1** Manual's Revisions

| Manual's Revisions | Power Supply's Manufacturing Date |            |
|--------------------|-----------------------------------|------------|
|                    | From                              | To         |
| 00                 | April 2022                        | March 2026 |
| 01                 | April 2026                        | To date    |

**Figure A.1** Manufacturing date on the Information label

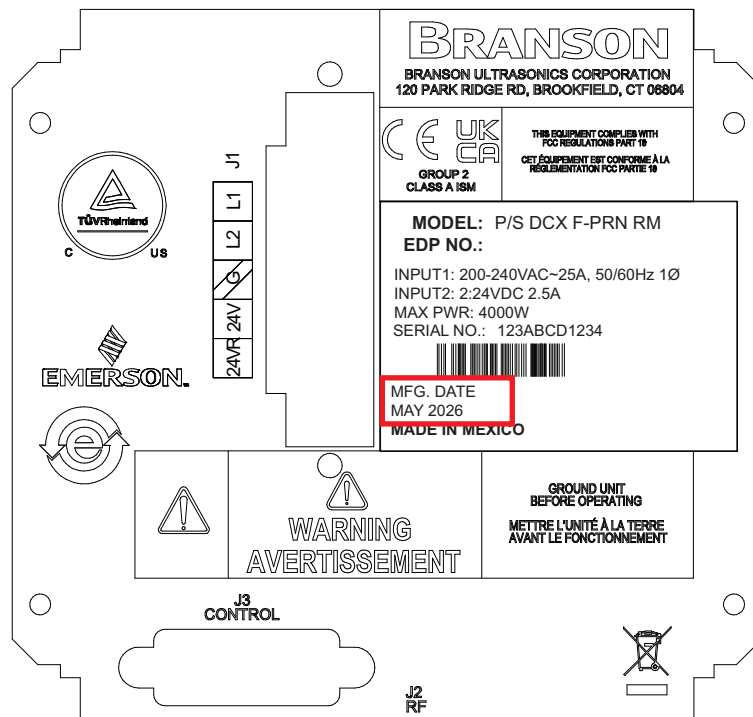

**Figure A.2** Location of the Information label on the back of the DCX S Power Supply

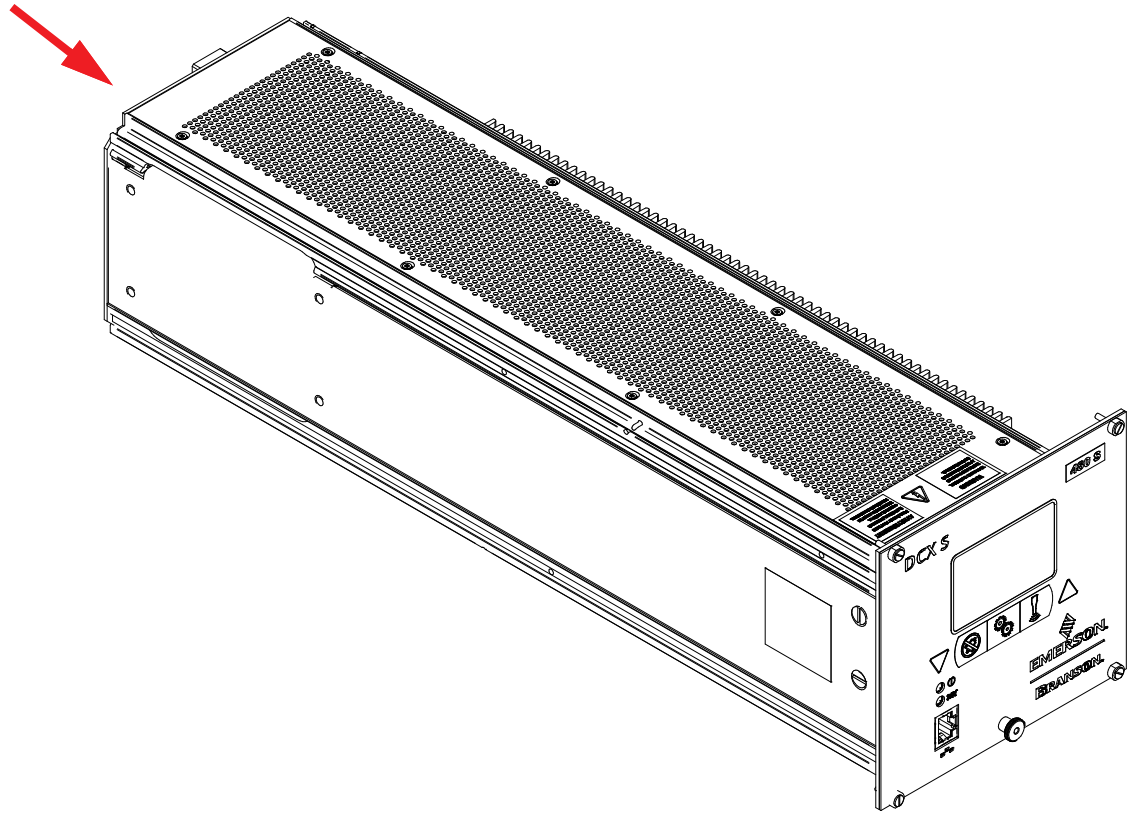



---

# Index

---

**A**

Abort Horn Scan 29  
Alarm 34  
Alarm # 34  
Alarm Log 34  
Alarms - Reset Required 23  
Amplitude 22, 27  
Amplitude Ramp (ms) 22  
Analog Inputs 24  
Analog Outputs 25

**C**

Clear Log 35  
Clear Memory before Seek 23  
Clear memory with Reset 23  
Command Buttons 18, 35  
Contact Branson 6  
Controller Version 30  
CRC 30

**D**

Data1 35  
Data2 35  
Days 34  
DHCP Client 21  
DHCP Server Enabled 20  
Digital Inputs 24  
Digital Outputs 24  
Digital Tune (Hz) 23  
Display 30  
Draw from... to... 27, 29

**E**

Emissions 5  
End of Weld Store 23  
Ethernet Port 12  
Export Graph Data 27, 29  
Export to Excel 35  
External 22

**F**

Frequency 23, 27, 30  
Frequency Offset (Hz) 23

**G**

Gateway 20  
General Precautions 4

Graph Selection 27, 29

## H

Horn Signature 28, 29

Hours 34

## I

I/O Diagnostics 24

inputs

analog 32

digital 32

Intended Use of the System 5

Internal Offset (Hz) 23

Introduction 8

IP Address 20

IP Setup 20

## J

J3-1 External Start 24

J3-10 Seek/Scan Out 24

J3-17 Amplitude In (V) 24

J3-18 Frequency Offset (V) 24

J3-2 External Seek 24

J3-24 Power Out (V) 25

J3-25 Amplitude Out (V) 25

J3-3 External Reset 24

J3-4 Memory Clear 24

J3-7 Ready 24

J3-8 Sonics Active 24

J3-9 General Alarm 24

## L

LCD CRC 30

LCD Software Version 30

Login 19

## M

MAC Address 20

Memory 27

Menu Display 18

Menu Navigation Tabs 18

Misc Setup 23

Models Covered 9

## O

Off 23

OK - Memory Stored 27

outputs

analog 33

digital 32

Overload - Cleared 27

## P

P/S Version 30

- Parallel Resonant Points 29
- Point to Point Connection 14
- Power 27
- Power Level 30
- Power On 23
- Power Supply 30

## **R**

- Redraw Graph 27, 29
- Reset Overload 27
- Result 29

## **S**

- Safety and Support 1
- Safety Requirements 2
- Scan 23
- Seek 23, 27
- Seek & Weld Graphs 26
- Seek Ramp (ms) 23
- Seek Time (ms) 23
- Serial Number 30
- Series Resonant Points 29
- Set Default 27, 29
- Start Horn Scan 29
- Static IP 20
- Status 29
- Subnet Mask 20
- Symbols 2
- System 30
- System Information 30
- System Requirements 13

## **T**

- Timed Seek 23

## **U**

- Update Graph 27, 29
- Update Value 27, 29
- UserID 34

## **W**

- Warnings 2
- Web Page Interface 18, 38
- WebSite Version 30
- Weld Amplitude (%) 22
- Weld Preset 22

