



# DCX 222 RM

## SIG Power Supply

# Operating Manual

**Branson Ultrasonics Corp.**  
120 Park Ridge Road  
Brookfield, CT 06804  
(203) 796-0400  
<http://www.bransonultrasonics.com>

**BRANSON**

## Manual Change Information

At Branson, we strive to maintain our position as the leader in ultrasonics plastics joining, metal welding, cleaning and related technologies by continually improving our circuits and components in our equipment. These improvements are incorporated as soon as they are developed and thoroughly tested.

Information concerning any improvements will be added to the appropriate technical documentation at its next revision and printing. Therefore, when requesting service assistance for specific units, note the Revision information found on this document, and refer to the printing date which appears on this page.

## Copyright and Trademark Notice

Copyright © 2026 Branson Ultrasonics Corporation. All rights reserved. Contents of this publication may not be reproduced in any form without the written permission of Branson Ultrasonics Corporation.

Mylar is a registered trademark of DuPont Teijin Films.

Loctite is a registered trademark of Loctite Corporation.

WD-40 is a registered trademark of WD-40 Company.

Windows 10, Windows 11, and Microsoft Edge are registered trademarks of Microsoft Corporation.

Google Chrome is a trademark of Google LLC.

Other trademarks and service marks mentioned herein are held by their respective owners.

## Foreword

Congratulations on your choice of a Branson Ultrasonics Corporation system!

The Branson DCX 222 RM SIG Power Supply system is process equipment for the joining of plastic parts using ultrasonic energy. It is the newest generation of product using this sophisticated technology for a variety of customer applications. This Operating Manual is part of the documentation set for this system, and must be kept with the equipment.

Thank you for choosing Branson!

## Introduction

This manual is arranged into several structured chapters which will help you find the information you may need to know to safely handle, install, set up, program, operate, and/or maintain this product. Please refer to the [Table of Contents](#) and/or the [Index](#) of this manual to find the information you may be looking for. In the event you require additional assistance or information, please contact our Product Support department (see [1.3 How to Contact Branson](#) for information on how to contact them) or your local Branson representative.



---

# Table of Contents

---

## Chapter 1: Safety and Support

1.1	Safety Requirements and Warnings . . . . .	2
1.2	General Precautions . . . . .	6
1.3	How to Contact Branson . . . . .	8

## Chapter 2: Introduction

2.1	Models Covered . . . . .	10
2.2	Compatibility with other Branson Products . . . . .	12
2.3	Features . . . . .	13
2.4	Controls and Indicators. . . . .	16
2.5	Welding Systems . . . . .	22
2.6	Glossary . . . . .	23

## Chapter 3: Delivery and Handling

3.1	Shipping and Handling . . . . .	26
3.2	Receiving . . . . .	27
3.3	Unpacking the Power Supply . . . . .	28
3.4	Take Inventory of Small Parts . . . . .	29
3.5	Returning Equipment . . . . .	30

## Chapter 4: Technical Specifications

4.1	Technical Specifications . . . . .	32
4.2	Physical Description . . . . .	34
4.3	EU Declaration of Conformity. . . . .	35
4.4	UK Declaration of Conformity . . . . .	36

## Chapter 5: Installation and Setup

5.1	About Installation. . . . .	38
5.2	Installation Requirements . . . . .	39
5.3	Installation Steps. . . . .	42
5.4	Power Supply Configuration. . . . .	52
5.5	Assembling the Acoustic Stack. . . . .	54
5.6	Converter Cooling . . . . .	57
5.7	Testing the Installation. . . . .	58
5.8	Still Need Help? . . . . .	59

## Chapter 6: Converters and Boosters

6.1	Converters and Boosters. . . . .	62
-----	----------------------------------	----

## Chapter 7: Operation

7.1	Setting Primary Parameters. . . . .	70
7.2	Setting Limits . . . . .	77
7.3	Setting the Amplitude. . . . .	83
7.4	Resetting the Power Supply Alarms . . . . .	86
7.5	Configuring the Power Supply Registers . . . . .	87
7.6	LCD Bar-Graph . . . . .	92
7.7	Web Page Interface . . . . .	94
7.8	Ultrasonics Test Procedure . . . . .	98

## **Chapter 8: Maintenance**

8.1	General Maintenance Considerations . . . . .	102
8.2	Preventive Maintenance . . . . .	104
8.3	Calibration . . . . .	108
8.4	Recommended Spare Stock . . . . .	109
8.5	Troubleshooting . . . . .	110

## **Appendix A: Signal Diagrams**

A.1	Signal Diagrams . . . . .	114
-----	---------------------------	-----

## **Appendix B: Manual's Revisions**

B.1	Manual's Revisions . . . . .	124
-----	------------------------------	-----

# List of Figures

## Chapter 1: Safety and Support

Figure 1.1	Safety-related Labels found on the DCX 222 RM SIG Power Supply	4
Figure 1.2	Safety-related Labels found on the DCX 222 RM SIG Power Supply (back)	5

## Chapter 2: Introduction

Figure 2.1	The DCX 222 RM SIG Power Supply	11
Figure 2.2	DCX 222 RM SIG Power Supply Front Panel Controls and Indicators	16
Figure 2.3	LCD Description	18
Figure 2.4	DCX 222 RM SIG Power Supply Front Panel	20
Figure 2.5	DCX 222 RM SIG Power Supply Back Panel	20

## Chapter 3: Delivery and Handling

## Chapter 4: Technical Specifications

Figure 4.1	EU Declaration of Conformity	35
Figure 4.2	UK Declaration of Conformity	36

## Chapter 5: Installation and Setup

Figure 5.1	DCX 222 RM SIG Power Supply Dimensional Drawing (Medium)	40
Figure 5.2	LCD Viewing Angle	43
Figure 5.3	DCX 222 RM SIG Power Supply Connections	44
Figure 5.4	User I/O Cable Identification and Wire Color Diagram	45
Figure 5.5	Typical Digital I/O Wiring Examples	48
Figure 5.6	Typical Analog I/O Wiring Examples	48
Figure 5.7	RF Cable Connection	49
Figure 5.8	Assembling the Acoustic Stack	55

## Chapter 6: Converters and Boosters

Figure 6.1	20 kHz 932 AS Converter Dimensions	63
Figure 6.2	20 kHz Booster Dimensions	64
Figure 6.3	20 kHz Converter/Booster/Horn, Typical Dimensions	65

## Chapter 7: Operation

Figure 7.1	Peak Power Window Limits	77
Figure 7.2	LCD at Power Up	83
Figure 7.3	LCD when in External Amplitude Control Mode	85
Figure 7.4	Test Connections	100

## Chapter 8: Maintenance

Figure 8.1	Reconditioning Stack Mating Surfaces	106
------------	--------------------------------------	-----

## Appendix A: Signal Diagrams

Figure A.1	Time	114
Figure A.2	Time Mode (Window Alarm)	115
Figure A.3	Time Mode (Overload Alarm)	116
Figure A.4	Energy Mode	117
Figure A.5	Energy Mode (Window Alarm)	118
Figure A.6	Energy Mode (Window Low Alarm - Start Signal Too Short)	119
Figure A.7	Energy Mode (Window Low Alarm - Max. Weld Time Reached)	120

Figure A.8 Energy Mode (Overload Alarm) . . . . . 121

**Appendix B: Manual's Revisions**

Figure B.1 Manufacturing date on the Information label . . . . . 124  
Figure B.2 Location of the Information label on the back of the DCX 222 RM SIG Power Supply 125

# List of Tables

## Chapter 1: Safety and Support

Table 1.1	Authorized Service Centers (Europe)	8
-----------	-------------------------------------	---

## Chapter 2: Introduction

Table 2.1	Models Covered in this manual	10
Table 2.2	Power Supply Compatibility with Branson Converters	12
Table 2.3	Control Features	13
Table 2.4	DCX 222 RM SIG Power Supply Front Panel Controls and Indicators	16
Table 2.5	LCD Description	18
Table 2.6	Connections to the DCX 222 RM SIG Power Supply	20
Table 2.7	Glossary	23

## Chapter 3: Delivery and Handling

Table 3.1	Shipping Specifications	26
Table 3.2	Inspect the power supply	27
Table 3.3	Unpacking the power supply	28
Table 3.4	Small Parts included (=x): Power Supply Assemblies	29

## Chapter 4: Technical Specifications

Table 4.1	Environmental Specifications	32
Table 4.2	Electrical Input Operating Voltages	33
Table 4.3	Input Current and Fuse Specifications	33
Table 4.4	Dimensions and Weights of DCX 222 RM SIG Power Supply	34

## Chapter 5: Installation and Setup

Table 5.1	Environmental Requirements	41
Table 5.2	Input Current and Circuit Breaker Specifications	41
Table 5.3	DCX 222 RM SIG Power Supply Connections	44
Table 5.4	User I/O Cable Pin Assignments	46
Table 5.5	Available Digital Input Functions	47
Table 5.6	Available Digital Output Functions	47
Table 5.7	Available Analog Input Functions	47
Table 5.8	Available Analog Output Functions	48
Table 5.9	RF Cable Connection	49
Table 5.10	Input Power Connection	50
Table 5.11	Selecting the Alarm Mode	52
Table 5.12	Configuring the Power Supply	52
Table 5.13	Acoustic Stack Description	55
Table 5.14	Stack Torque Values	55
Table 5.15	Tools	56
Table 5.16	20 kHz System	56
Table 5.17	Continuous Duty Max. Power & Full Power Duty Cycle	57
Table 5.18	Converter Cooling Procedure	57

## Chapter 6: Converters and Boosters

Table 6.1	20 kHz CH-20S Converter Dimensions	63
Table 6.2	20 kHz Booster Dimensions	64
Table 6.3	20 kHz Converter/Booster/Horn, Typical Dimensions	65

## Chapter 7: Operation

Table 7.1	Summary of Weld Modes . . . . .	70
Table 7.2	Selecting Continuous Mode . . . . .	71
Table 7.3	Time Mode Parameters . . . . .	73
Table 7.4	Selecting Time Mode . . . . .	73
Table 7.5	Setting Time Mode Parameters . . . . .	74
Table 7.6	Energy Mode Parameters . . . . .	75
Table 7.7	Selecting Energy Mode . . . . .	75
Table 7.8	Setting Energy Mode Parameters . . . . .	76
Table 7.9	+Peak Power Window Parameters . . . . .	77
Table 7.10	+Peak Power Window Limit Operational Sequence . . . . .	78
Table 7.11	+Peak Power Window Limit Operational Sequence - Registers . . . . .	79
Table 7.12	-Peak Power Window Limit Parameters . . . . .	80
Table 7.13	-Peak Power Window Limit Operational Sequence . . . . .	81
Table 7.14	-Peak Power Window Limit Operational Sequence (Registers) . . . . .	81
Table 7.15	Setting the Amplitude Using the Front Panel Controls . . . . .	83
Table 7.16	Resetting the DCX 222 RM SIG Power Supply . . . . .	86
Table 7.17	Steps to Configure the Power Supply Registers . . . . .	87
Table 7.18	Power Supply Registers . . . . .	89
Table 7.19	Power Bar-Graph Interpretation Examples . . . . .	92
Table 7.20	Frequency Bar-Graph Interpretation . . . . .	93
Table 7.21	Frequency Bar-Graph Interpretation Examples . . . . .	93
Table 7.22	Power Supply Ultrasonic Test Procedure (Front Panel) . . . . .	99
Table 7.23	Power Supply Ultrasonic Test Procedure (User I/O) . . . . .	100

## Chapter 8: Maintenance

Table 8.1	Stack Reconditioning Procedure . . . . .	105
Table 8.2	Reconditioning Stack Mating Surfaces . . . . .	106
Table 8.3	Stack Torque Value . . . . .	107
Table 8.4	Stack Reassembly for a 20 kHz System . . . . .	107
Table 8.5	Stud Torque Values . . . . .	107
Table 8.6	Converters Compatible with the DCX 222 RM SIG Power Supply . . . . .	109
Table 8.7	DCX 222 RM SIG Power Supply Compatible Boosters . . . . .	109
Table 8.8	Other Items used with the DCX 222 RM SIG Power Supply . . . . .	109
Table 8.9	Troubleshooting . . . . .	110
Table 8.10	Troubleshooting Common Electrical Problems . . . . .	110
Table 8.11	Troubleshooting Ultrasonic Power Problems . . . . .	111
Table 8.12	Troubleshooting Weld Cycle Problems . . . . .	112

## Appendix A: Signal Diagrams

## Appendix B: Manual's Revisions

Table B.1	Manual's Revisions . . . . .	124
-----------	------------------------------	-----

---

# **Chapter 1: Safety and Support**

---





**1.1 Safety Requirements and Warnings . . . . .2**  
**1.2 General Precautions . . . . .6**  
**1.3 How to Contact Branson . . . . .8**




## 1.1 Safety Requirements and Warnings

This chapter contains an explanation of the different Safety Notice symbols and icons found both in this manual and on the product itself and provides additional safety information for ultrasonic welding. This chapter also describes how to contact Branson for assistance.

### 1.1.1 Symbols Found in this Manual

These symbols used throughout this manual warrant special attention:

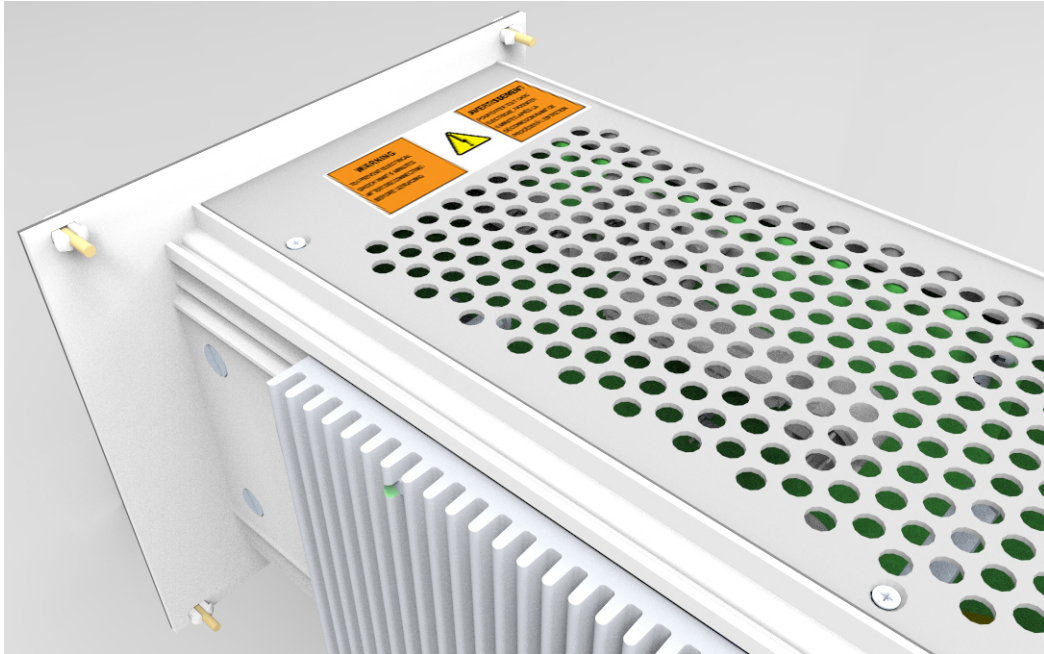
<b>WARNING</b>	<b>Indicates a possible danger</b>
	If these risks are not avoided, death or severe injury might result.
<b>WARNING</b>	<b>High Voltage Hazard</b>
	High voltage. Turn power off before servicing.
<b>WARNING</b>	<b>Corrosive Material Hazard</b>
	Corrosive material. Avoid contact with eyes and skin. Wear proper protection.
<b>CAUTION</b>	<b>Indicates a possible danger</b>
	If these risks are not avoided, slight or minor injury might result.

<b>CAUTION</b>	<b>Loud Noise Hazard</b>
	<p>Loud Noise Hazard. Ear protection must be worn.</p>
<b>CAUTION</b>	<b>Heavy Object</b>
	<p>Heavy object. To avoid muscle strain or back injury, use lifting aids and proper lifting techniques.</p>
<b>NOTICE</b>	<b>Indicates a possible damaging situation</b>
	<p>If this situation is not avoided, the system or something in its vicinity might get damaged.</p> <p>Application types and other important or useful information are emphasized.</p>

## 1.1.2 Symbols Found on the Product

The DCX 222 RM SIG Power Supply has several safety-related labels on it to indicate the presence of hazardous voltages inside the unit.

**Figure 1.1** Safety-related Labels found on the DCX 222 RM SIG Power Supply



### WARNING

TO PREVENT ELECTRICAL SHOCK WAIT 5 MINUTES AFTER DISCONNECTING BEFORE SERVICING



### AVERTISSEMENT

POUR ÉVITER TOUT CHOC ÉLECTRIQUE, PATIENTER 5 MINUTES APRÈS LA DÉCONNEXION AVANT DE PROCÉDER À L'ENTRETIEN.


**Figure 1.2** Safety-related Labels found on the DCX 222 RM SIG Power Supply (back)





## 1.2 General Precautions

Take the following precautions before servicing the power supply:

- To prevent the possibility of an electrical shock, always plug the power supply into a grounded power source
- To prevent the possibility of an electrical shock, ground the power supply by securing an AWG #8 gauge grounded conductor to the ground screw located next to the air outlet
- Power supplies produce high voltage. Before working on the power supply assembly, do the following:
  - Turn off the power supply
  - Unplug main power
  - Allow at least 5 minutes for capacitors to discharge
- High voltage is present in the power supply. Do not operate with the cover removed
- High line voltages exist in the ultrasonic power supply assembly. Common points are tied to circuit reference, not chassis ground. Therefore, use only non-grounded, battery-powered multimeters when testing the power supply assembly. Using other types of test equipment can present a shock hazard
- Keep hands from under the horn. Down force (pressure) and ultrasonic vibrations can cause injury
- Do not cycle the welding system if either the RF cable or converter is disconnected
- When using larger horns, avoid situations where fingers could be pinched between the horn and the fixture
- Ensure power supply installation is performed by qualified personnel and in accordance with local standards and regulations

CAUTION	Loud Noise Hazard
	<p>Sound level and frequency of the noise emitted during the ultrasonic assembly process may depend upon <b>a.</b> type of application, <b>b.</b> size, shape and composition of the material being assembled, <b>c.</b> shape and material of the holding fixture, <b>d.</b> welder setup parameters and <b>e.</b> tool design.</p> <p>Some parts vibrate at an audible frequency during the process. Some or all of these factors may result in an uncomfortable noise being emitted during the process.</p> <p>In such cases operators may need to be provided with personal protective equipment. See 29 CFR (Code of Federal Regulations) 1910.95 Occupational Noise Exposure.</p>

NOTICE	
	<p>When the battery is worn out, dispose it under the ordinance of each local government.</p>

WARNING	Corrosive Material Hazard
	<p>First aid measures (in case of electrolyte leakage from the battery):</p> <p><b>Eye Contact:</b> Flush the eyes with plenty of clean water for at least 15 minutes immediately, without rubbing. Get immediate medical treatment. If appropriate procedures are not taken, this may cause eye injury.</p> <p><b>Skin Contact:</b> Wash the affected area under tepid running water using a mild soap. If appropriate procedures are not taken, this may cause sores on the skin. Get medical attention if irritation develops or persists.</p> <p><b>Inhalation:</b> Remove to fresh air immediately. Get medical treatment immediately.</p>

### 1.2.1 Intended Use of the System


The DCX 222 RM SIG Power Supply and components are designed to be used as part of an ultrasonic welding system. These are designed for a wide variety of welding or processing applications.

If the equipment is used in a manner not specified by Branson, the protection provided by the equipment may be impaired.

Branson Ultrasonics Corp. designs and manufactures machines giving the first priority to safety precautions, to allow customers to use the machines safely and effectively. Only trained operators must run and service the equipment. Untrained operators can misuse the equipment or ignore safety instructions that can result in personal injury or equipment damage. It is most essential that all operators and service personnel pay attention to safety instructions when operating and servicing the equipment.

### 1.2.2 Emissions

Because of the various types of toxic or injurious gases that may be liberated during the welding based on the material being processed, sufficient ventilation must be provided to prevent a concentration of these gases in excess of 0.1 ppm. Check with your materials suppliers for recommended protection when processing their materials.

WARNING	Corrosive Material Hazard
	<p>Processing of many materials, such as PVC, can be hazardous to an operator's health and could cause corrosion/damage to the equipment. Use proper ventilation and take protective measures.</p>

### 1.2.3 Setting up the Workplace

Measures for setting up a workplace for safe operation of the ultrasonic welder are outlined in [Chapter 5: Installation and Setup](#).

### 1.2.4 Regulatory Compliance

This product meets electrical safety requirements and EMC (Electromagnetic Compliance) requirements for North America, Great Britain and the European Union.

## 1.3 How to Contact Branson

Branson is here to help you. We appreciate your business and are interested in helping you successfully use our products. To contact Branson for help, use the following telephone numbers, or contact the office nearest you.

### 1.3.1 Authorized Service Centers (Europe)

**Table 1.1** Authorized Service Centers (Europe)

Name	Address	Tel/Fax Number
Branson Ultraschall European Headquarters Germany	Niederlassung der EMERSON Technologies GmbH & Co. OHG Waldstraße 53-55 63128 Dietzenbach, Germany	Tel: 49 (0)6074/497-0 Tel: 49 (0)6074/497-784 Fax: 49 (0)6074/497-199 <a href="mailto:info@branson.de">info@branson.de</a>

---

# **Chapter 2: Introduction**

---

- 2.1 Models Covered. . . . .10**
- 2.2 Compatibility with other Branson Products . . . . .12**
- 2.3 Features . . . . .13**
- 2.4 Controls and Indicators . . . . .16**
- 2.5 Welding Systems. . . . .22**
- 2.6 Glossary . . . . .23**

## 2.1 Models Covered

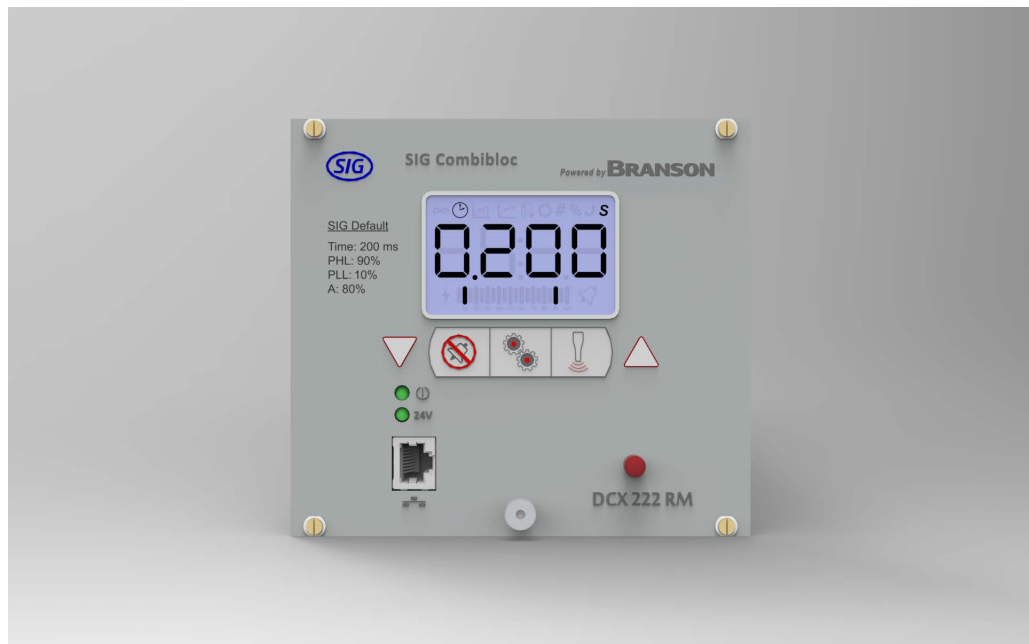
This manual covers all models of the DCX 222 RM SIG Power Supply.

**Table 2.1** Models Covered in this manual

Frequency	Power	EDP
20 kHz	2200 W	159-132-2113

### 2.1.1 Overview of This Model

**Figure 2.1** The DCX 222 RM SIG Power Supply



The DCX 222 RM SIG Power Supply generates ultrasonic energy through an ultrasonic converter for welding plastics. One model is available, with a frequency of 20 kHz and a power range 2.2 kW. The power supply also contains a microprocessor-based controller module that provides for control and monitoring of welding operations.

The power supply provides the following features:

**End of Weld Store:** Allows the power supply to track and store the frequency of the last weld.

**Timed Seek:** Tracks and starts the stack on the correct frequency. It does this by running the horn at a low-level amplitude (10%) to find and lock on to the stack operating frequency. Seeks are timed from the moment sonics was last activated.

**Line Regulation:** Maintains converter amplitude by regulating for variances in the line voltages.

**Load Regulation:** Maintains converter amplitude over the full range of rated power.

**System Protection:** Protects the power supply by providing six levels of protection.

- Voltage
- Current
- Phase
- Temperature
- Power
- Frequency

**Web Page Interface:** Provides access, via Ethernet connection, to power supply information, diagnostics, and configuration web pages.

**Frequency Offset:** Provides for applying an external frequency offset to the operating frequency.

**Amplitude Control:** Provides complete control of amplitude throughout the weld cycle: programmable starting ramp, and digital setting of weld amplitude.

## 2.2 Compatibility with other Branson Products

**Table 2.2** Power Supply Compatibility with Branson Converters

<b>DCX 222 RM Models</b>	<b>Converter</b>
20 kHz	932 AS

## 2.3 Features

### 2.3.1 The Welding System

The welding system consists of a DCX 222 RM SIG Power Supply and a converter-booster-horn stack. The system can perform ultrasonic welding, inserting, staking, spot welding, swaging, degating, and continuous ultrasonic operations. It is designed for automated, semi-automated and/or manual production operations.

### 2.3.2 The Power Supply

The DCX 222 RM SIG Power Supply consists of an ultrasonic power supply assembly with a system controller and user interfaces. The ultrasonic power supply assembly converts conventional 50/60 Hz line current to 20 kHz, electrical energy. The system controller controls the welding system.

Listed below are the control features of the DCX 222 RM SIG Power Supply ultrasonic welding system:

**Table 2.3** Control Features

Name	Description
Autotuning	Branson power supply tuning ensures that the system is running at peak efficiency.
Digital Amplitude Setting	This feature allows you to set the exact amplitude necessary for your application, allowing increased range and setting repeatability over analog systems.
Frequency Offset	This process feature allows a user to set an offset relative to the starting frequency, for certain specific applications, where the force imparted on the fixture or anvil causes a frequency shift in the stack's operation. You must only use this feature when advised to do so by Branson.
Horn Signature	Using the DCX 222 RM SIG Power Supply Web Page Interface, you may scan your ultrasonic stack to view its operating frequency on your computer, using digital readouts to give you the best picture of the stack's operation.
LCD (Liquid Crystal Display)	Provides a clear visual interface to monitor and configure the system.
Line Regulation	Maintains converter amplitude by regulating for variances in the line voltages.
Load Regulation	Maintains converter amplitude over the full range of rated power.
Membrane Keys	Front panel controls are designed for high reliability and immunity from factory dust and oils.
User ID and Passcodes	Allows for keeping track of user access to the DCX 222 RM SIG Power Supply Web Page Interface.
Ramp Starting	The starting of the DCX 222 RM SIG Power Supply and horn is done at a rate that helps reduce electrical and mechanical stress on the system. The horn start rate may be adjusted for some tough-to-start applications.

**Table 2.3** Control Features

Name	Description
Seek	Ensures operation at resonance; minimizes tuning errors; and operates the stack at low amplitude (10%), then provides a means of sensing and storing the resonant operating frequency value.
Start-up Diagnostics	At start-up, the controls test the major internal components.
System Protection	Protects the power supply by providing six levels of protection: voltage, current, phase, temperature, power, and frequency.
Timed Seek	When enabled, will do a Seek once every minute to update horn resonant frequency to memory. This is especially useful when the welding process affects the actual temperature of the horn, causing a resonant frequency shift.
True Watt-meter	The controls on the power supply include a true watt-meter for accurate measurement of power and energy.
Web Page Interface	Provides access, via Ethernet connection, to power supply information, diagnostics, and configuration web pages.

### 2.3.3 The Actuator

The DCX 222 RM SIG Power Supply does not provide actuator control functions, and does not interface with actuator signals.

### 2.3.4 Converter/Booster/Horn Assembly

#### The Converter

The ultrasonic electrical energy from the power supply is applied to the converter (sometimes called the transducer). This transforms the high frequency electrical oscillations into mechanical vibrations at the same frequency as the electrical oscillations. The heart of the converter is piezoelectric ceramic elements. When subjected to an alternating voltage, these elements alternately expand and contract, resulting in better than 90% conversion of electrical to mechanical energy.

#### The Booster

Success in ultrasonic assembly depends on the right amplitude of movement at the horn face. Amplitude is a function of horn shape, which is largely determined by the size and form of the parts to be assembled. The booster can be used as a mechanical transformer to increase or decrease the amplitude of vibrations applied to the parts through the horn.

The booster is a resonant half-wave section of aluminum or titanium. It is mounted between the converter and the horn, as part of the ultrasonic stack. It also provides a clamping point for rigid stack mounting.

Boosters are designed to resonate at the same frequency as the converter with which they are used. Boosters are usually mounted at a nodal (minimum vibration) point of axial motion. This minimizes the loss of energy and prevents vibration from being transmitted to the stack supporting structure.

#### The Horn

The horn is selected or designed for a specific application. Each horn is tuned typically as a half-wave section that applies the necessary force and vibration uniformly to the parts to be assembled. It transfers ultrasonic vibrations from the converter to the workpiece. The horn is mounted to the booster as part of the ultrasonic stack.

Depending on their profile, horns are referred to as stepped, conical, exponential, bar, or catenoidal. The shape of the horn determines the amplitude at the face of the horn. Depending on the application, horns can be made from titanium alloys, aluminum, or steel. Titanium alloys are the best materials for horn fabrication due to their high level of strength and low loss. Aluminum horns are usually chrome- or nickel-plated or hard-coated to reduce wear. Steel horns are for low amplitude requiring hardness, such as ultrasonic insertion applications.

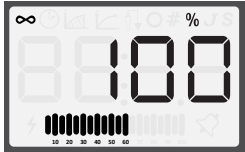


## 2.4 Controls and Indicators

### 2.4.1 DCX 222 RM SIG Power Supply Front Panel

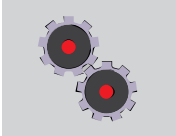
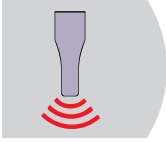
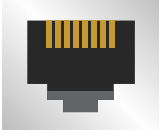


**Figure 2.2** DCX 222 RM SIG Power Supply Front Panel Controls and Indicators



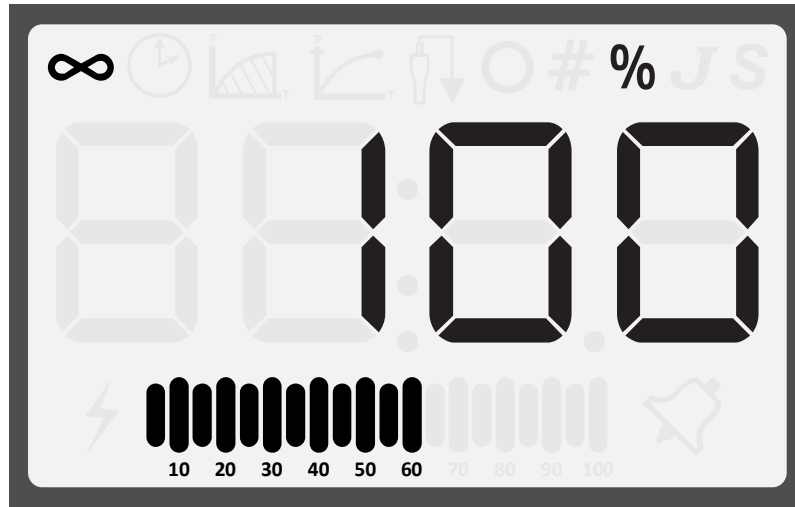
**Table 2.4** DCX 222 RM SIG Power Supply Front Panel Controls and Indicators

Reference	Description
	<p><b>LCD</b></p> <p>For detailed information refer to <a href="#">Figure 2.3 LCD Description</a> and <a href="#">Table 2.5 LCD Description</a>.</p>
	<p><b>Up/Down Keys</b></p> <p>Use to adjust the amplitude of ultrasonic vibrations (10% to 100%). Also used to adjust weld mode parameters, select registers and edit register values.</p>
	<p><b>Alarm Reset Key</b></p> <p>Use the Reset key to reset alarms.</p> <p>When changing system registers, use the Reset key to set a register back to its default value after entering the register and before editing the value.</p>

**Table 2.4** DCX 222 RM SIG Power Supply Front Panel Controls and Indicators

Reference	Description
	<p><b>Configuration Key</b></p> <p>Use the Configuration key to change system registers. Registers are used to change system parameters. For information on using the Configuration key to set system registers see <a href="#">7.5 Configuring the Power Supply Registers</a>.</p>
	<p><b>Ultrasonics Test Key</b></p> <p>Use the Test key to perform an ultrasonic test. Test performs a seek and then ramps the amplitude to the current setting.</p>
	<p><b>Ethernet Port</b></p> <p>Use the Ethernet Port to connect to the DCX 222 RM SIG Power Supply Web Page Interface.</p>
	<p><b>Power-On Indicator</b></p> <p>Lights when the power supply is connected to main power.</p>
	<p><b>24 V Indicator</b></p> <p>Lights when 24 V DC are supplied to the DCX 222 RM SIG Power Supply.</p>

**Figure 2.3** LCD Description



**Table 2.5** LCD Description



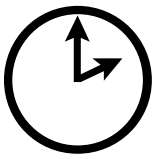
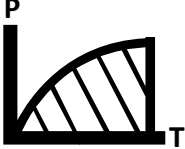

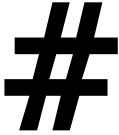





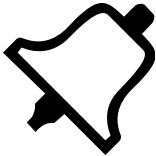
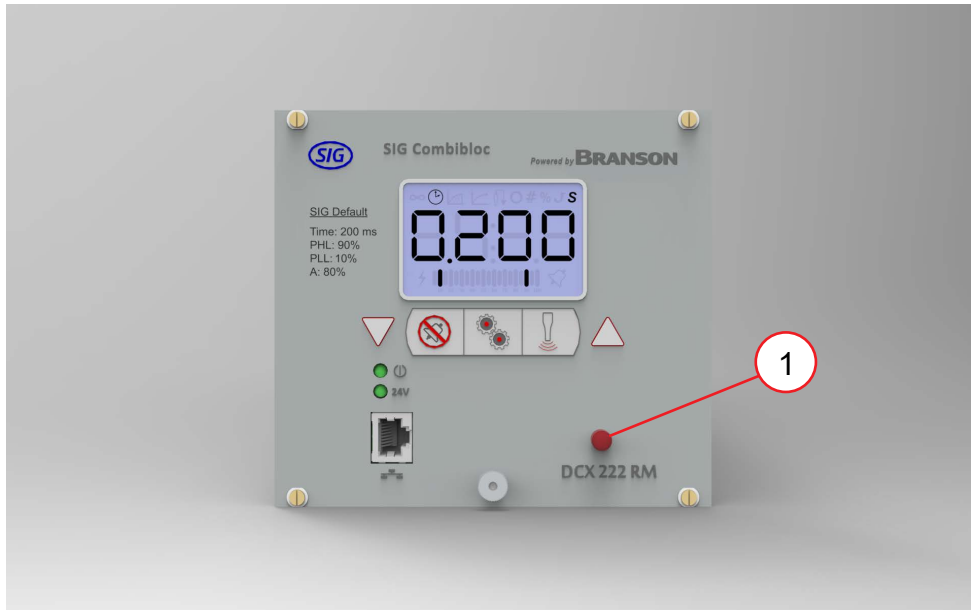
Reference	Description
	<p><b>Numeric Display</b></p> <p>Displays the Power Supply amplitude settings, register numbers, register values or alarm numbers.</p>
	<p><b>Continuous Mode Icon</b></p> <p>Indicates the power supply is running in Continuous mode. When in Continuous mode, the amplitude setting is shown on the numeric display in conjunction with the % icon. The amplitude setting may range from 10% to 100%. For more information see <a href="#">Chapter 7: Operation</a>.</p>
	<p><b>Time Mode Icon</b></p> <p>Indicates the power supply is running in Continuous mode. When in Continuous mode, the amplitude setting is shown on the numeric display in conjunction with the % icon. The amplitude setting may range from 10% to 100%. For more information see <a href="#">7.1.2 Selecting Time Mode</a>.</p>
	<p><b>Energy Mode Icon</b></p> <p>Indicates the power supply is running in Energy mode. When in Energy mode, the weld energy setting is shown on the numeric display in conjunction with the J icon. The energy setting may range from 1 Joule to 9999 Joules. For more information see <a href="#">7.1.3 Selecting Energy Mode</a>.</p>
	<p><b>Circle Icon</b></p> <p>Indicates that the value shown on the numeric display is a register value. Use up and down keys to modify the register value. For more information see <a href="#">7.5 Configuring the Power Supply Registers</a>.</p>

Table 2.5 LCD Description

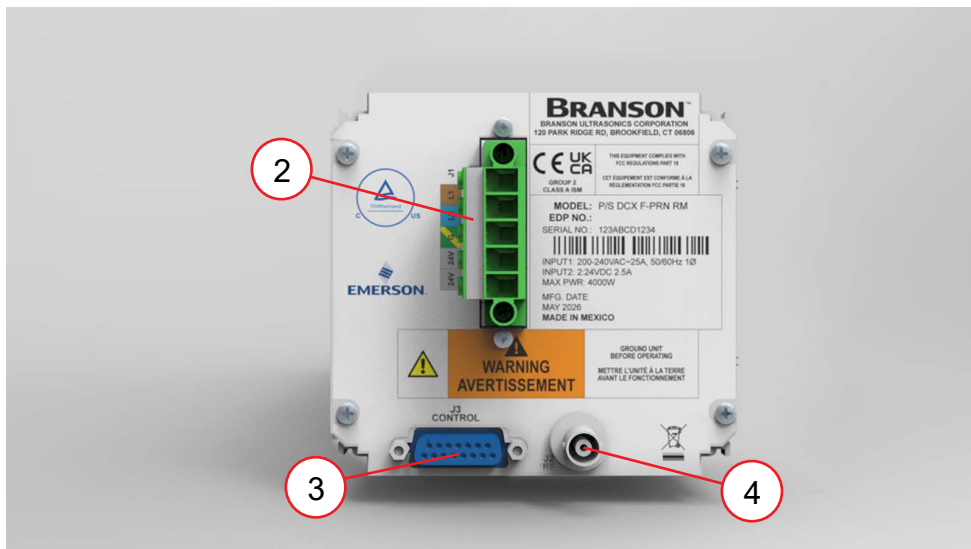
Reference	Description
	<p><b>Number Sign Icon</b></p> <p>Indicates that the value shown on the numeric display is a register number. Use up and down keys to select a register. For more information see <a href="#">7.5 Configuring the Power Supply Registers</a>.</p>
	<p><b>Percentage Icon</b></p> <p>Indicates that the value shown on the numeric display represents a percentage. When in Peak Power mode, the value shown on the numeric display represents a percentage of the power supply rated power. If not in Peak Power mode, the value shown on the numeric represents the amplitude setting.</p>
	<p><b>Joule Icon</b></p> <p>Indicates that the value shown on the numeric display represents energy.</p>
	<p><b>Time Icon</b></p> <p>Indicates that the value shown on the numeric display represents time in seconds.</p>
	<p><b>Sonics Active Indicator</b></p> <p>Indicates ultrasonics is running.</p>
	<p><b>Power/Frequency Bar-Graph</b></p> <p>Shows the true percentage of ultrasonic power during a weld cycle. The bar-graph can be configured to show the peak power or the memory frequency at the end of each weld or test cycle. For instructions on how to modify this setting see <a href="#">7.5 Configuring the Power Supply Registers</a>.</p> <p>For detailed bar-graph description and bar-graph reading examples, see <a href="#">7.6.1 Power Bar-Graph Interpretation</a> and <a href="#">7.6.2 Frequency Bar-Graph Interpretation</a>.</p>
	<p><b>Alarm Icon</b></p> <p>A flashing icon which indicates and alarm condition.</p>

## 2.4.2 DCX 222 RM SIG Power Supply Connections

**Figure 2.4** DCX 222 RM SIG Power Supply Front Panel



**Figure 2.5** DCX 222 RM SIG Power Supply Back Panel



**Table 2.6** Connections to the DCX 222 RM SIG Power Supply

Item	Name	Function
1	Power Out Connector	Binding post connector provides power out read-out. 0 V: 0% Power 10 V: 100% Power
2	Line Input Connector	Detachable connector block for connecting the input power. For wiring details refer to <a href="#">Chapter 5: Installation and Setup</a> .

**Table 2.6** Connections to the DCX 222 RM SIG Power Supply

Item	Name	Function
3	User I/O Connector	Provides the necessary input/output signals to interface with user automation or control interfaces. For detailed information on interfacing with the DCX 222 RM SIG Power Supply refer to <a href="#">Chapter 5: Installation and Setup</a> .
4	RF Connector	MHV connector for RF cable, which provides ultrasonic energy to the converter.

## **2.5 Welding Systems**

### **2.5.1 Principle of Operation**

Thermoplastic parts are welded ultrasonically by applying high frequency vibrations to the parts being assembled. The vibrations, through surface and intermolecular friction, produce a sharp rise in temperature at the welding interface.

When the temperature is high enough to melt the plastic, there is a flow of material between the parts. When the vibrations stop, the material solidifies under pressure and a weld results.

### **2.5.2 Weld System Applications**

DCX 222 RM SIG Power Supply weld systems can be used for the following applications:

- Ultrasonic welding
- Cutting and sealing thermoplastic fabric and film
- Staking, spot welding, swaging, and degating thermoplastic parts
- Other ultrasonic processing applications

DCX 222 RM SIG Power Supply weld systems typically consist of a power supply operated with a fixed converter-booster-horn stack.

## 2.6 Glossary

The following terminology may be encountered when using or operating a DCX 222 RM SIG Power Supply ultrasonic welding system:

**Table 2.7** Glossary

Name	Description
Actuator	The unit which houses the converter/booster/horn stack assembly in a rigid mounting, allowing the stack to move up and down, either mechanically or pneumatically, applying force to the part at a user-adjustable force and velocity.
Alarm	Visual indication of error.
Amplitude Control	The ability to set amplitude digitally or by an external control.
Amplitude	The peak-to-peak movement at the horn face. Always expressed as a percentage of the maximum.
Booster	A one-half-wavelength-long resonant metal section mounted between the converter and horn, sometimes having a change in cross-sectional area between the input and output surfaces. The booster mechanically alters the amplitude of vibrations received from the converter, and imparts the new amplitude to the horn.
Clamping Force	The pounds or kilograms exerted by the horn onto the workpiece.
Cold Start	Restores the settings of the power supply back to its original condition.
Converter	The device that converts electrical energy into mechanical vibrations at a high frequency (an ultrasonic rate).
Counters	A record of the number of preset cycles recorded in the power supply.
Degating	Removing a molded part from its runner system.
Energy Director	A triangular-shaped projection of plastic material which concentrates the ultrasonic energy at the joint interface of a plastic part.
External Amplitude Control	Enables you to access real-time amplitude control directly via the user I/O connector.
External Frequency Control	Enables you to access real-time frequency offset control directly via the user I/O connector.
Fixture	A device for holding a part in position for assembly.
Flash	Material displaced from the joint area.
Forming	Reshaping a section of thermoplastic.
Fretting Corrosion	A black surface condition, that results from friction between metal parts, that appears on the converter-booster-horn stack mating surfaces.
Frequency	The operating frequency of the ultrasonic stack. The frequency stored is measured at the end of the ultrasonic portion of the cycle (when ultrasonics are terminated).

**Table 2.7** Glossary

Name	Description
Frequency Offset	An offset factor applied to the ultrasonic frequency stored in the power supply.
Gain	The ratio of output to input amplitude of a horn or booster.
Horn	A bar or metal section, usually one half-wavelength-long which transfers vibratory energy to the workpiece.
Horn Amplitude	The peak-to-peak displacement of a horn at its work face.
Horn Signature	A scan to enhance selection of operating frequency and control parameters.
Insertion	The process of embedding a metal component in plastic.
Interface	1. The contact surface of two mating parts. 2. The connection between two pieces of equipment.
Joint	The weld surfaces.
Parameter	A unique factor or element which affects the welding operation in a particular mode.
Parameter Range	Valid range of parameters accepted for a particular setup.
Power Supply	The electronic instrument in an ultrasonic assembly system which changes conventional 50/60 Hz electrical power into high frequency electrical power at 20 kHz, 30 kHz or 40 kHz.
Seek	The activation of ultrasonics at a low-level (10%) amplitude, for the purpose of finding the resonant frequency of the stack.
Staking	The process of melting and reforming a plastic stud to mechanically lock a dissimilar material in place.
Swaging	The process of capturing another component of an assembly by melting and reforming a ridge of plastic.
Thermoplastic	A polymer which undergoes a reversible change of state when subjected to heat.
Thermoset	A polymer which undergoes an irreversible change when subjected to heat.
Ultrasonic Power	Presence of ultrasonic power at the horn face.
Ultrasonic Welding	The use of ultrasonic vibrations to generate heat and subsequently melt the mating surfaces of two thermoplastic parts. When ultrasonic vibrations stop, the molten material resolidifies, and a weld occurs.
User ID	A unique 12 character long alphanumeric ID used to keep track of user access to the web page interface.
Weld System	A combination of components required to perform an ultrasonic operation. Usually consists of a power supply, converter, booster, and horn, with either an actuator or a handheld device, or in a fixed, mounted location.


---

## **Chapter 3: Delivery and Handling**

---

<b>3.1</b>	<b>Shipping and Handling</b> .....	<b>26</b>
<b>3.2</b>	<b>Receiving</b> .....	<b>27</b>
<b>3.3</b>	<b>Unpacking the Power Supply</b> .....	<b>28</b>
<b>3.4</b>	<b>Take Inventory of Small Parts</b> .....	<b>29</b>
<b>3.5</b>	<b>Returning Equipment</b> .....	<b>30</b>

## 3.1 Shipping and Handling

CAUTION	Heavy Object
	<p>The power supply may be heavy. Handling, unpacking, and installation may require the assistance of a colleague or the use of lifting platforms or hoists.</p>

### 3.1.1 Environmental Specifications

The DCX 222 RM SIG Power Supply is an electronic unit that converts line voltage to ultrasonic energy and responds to user input for regulating the weld process. Its internal components are sensitive to static discharge, and many of its components can be harmed if the unit is dropped, shipped under improper conditions, or otherwise mishandled.

The following environmental guidelines must be respected in the shipping of the power supply.

**Table 3.1** Shipping Specifications

Environmental Condition	Acceptable Range
Storage / Shipping Temperature	-25° C to +55° C (+70° C for 24 hours)
Shock / Vibration (transit)	45 g shock / 0.5 g and (3 to 100 Hz) vibration per ASTM 3332-88 and 3580-90
Drop Test	ISTA Procedure 1 & 2A (while packaged)
Humidity	Maximum 95%, non-condensing

## 3.2 Receiving

The DCX 222 RM SIG Power Supply is a sensitive electronic device. Many of its components can be harmed if the unit is dropped or otherwise mishandled.


### Scope of Delivery

Branson equipment is carefully checked and packed before dispatch. It is recommended, however, that you follow the procedure below upon receiving your DCX 222 RM SIG Power Supply.


### Inspect the Power Supply when it is delivered, take the following steps:

**Table 3.2** Inspect the power supply

Step	Action
1	Verify that all parts are complete according to the packing slip.
2	Check the packing and the unit for damage (visual inspection).
3	Report any damage claims to your carrier immediately.
4	Determine if any component has become loose during shipping and, if necessary, tighten screws.

NOTICE	
	<p>If the goods delivered have been damaged during shipping, please contact the forwarding agent immediately. Retain packing material (for possible inspection or for sending back the unit).</p>

## 3.3 Unpacking the Power Supply

NOTICE	
	<p>If there are any visible signs of damage to the shipping containers or the product, or you later discover hidden damage, NOTIFY YOUR CARRIER IMMEDIATELY. Save the packing material.</p>

The power supply is fully assembled. It is shipped in a sturdy cardboard box. Some additional items are shipped in the box with the power supply. Note orientation of packaging material in case return/repack is necessary. When unpacking the power supply, take the following steps:

**Table 3.3** Unpacking the power supply

Step	Action
1	Unpack the power supply as soon as it arrives. Save the packing material
2	Verify you have all of the equipment ordered. Some components are packed inside other boxes.
3	Inspect the controls, indicators, and surface for signs of damage.
4	Remove the cover of the power supply to check if any components became loose during shipping.

## 3.4 Take Inventory of Small Parts

**Table 3.4** Small Parts included (=x): Power Supply Assemblies

Part or Kit	20 kHz
Mylar <sup>®</sup> * plastic film Washer Kit	X
Spanners (2)	X

\* Mylar is a registered trademark of DuPont Teijin Films.

### 3.4.1 Cables

The RF cable connects the power supply to the converter. For automated systems you will also need a user I/O cable to monitor and control the power supply. Check your invoice for cable types and cable lengths.

## 3.5 Returning Equipment

If you are returning equipment to Branson Ultrasonic Corporation, please call your Customer Service Representative to receive approval to return the goods. Refer to [1.3 How to Contact Branson](#).


---

## **Chapter 4: Technical Specifications**

---

<b>4.1</b>	<b>Technical Specifications . . . . .</b>	<b>32</b>
<b>4.2</b>	<b>Physical Description . . . . .</b>	<b>34</b>
<b>4.3</b>	<b>EU Declaration of Conformity . . . . .</b>	<b>35</b>
<b>4.4</b>	<b>UK Declaration of Conformity . . . . .</b>	<b>36</b>

## 4.1 Technical Specifications

NOTICE	
	All specifications are subject to change without notice.

### 4.1.1 Environmental Specifications

The DCX 222 RM SIG Power Supply has the following environmental specifications:

**Table 4.1** Environmental Specifications

Environmental Condition	Acceptable Range
Ambient Operating Temperature	+5° C to +50° C
Storage / Shipping Temperature	-25° C to +55° C
Operating Altitude	2000 m
Humidity	Maximum 95%, non-condensing
IP Rating	20 Protected against solid objects larger than 12.5 mm; no protection against water.
Pollution Degree	2 Only non-conductive pollution occurs; temporary conductivity caused by condensation may be expected.
Overvoltage Category	II Equipment intended to be supplied from the building wiring.

## 4.1.2 Electrical Specifications


The following tables list input voltage and current requirements for the DCX 222 RM SIG Power Supply.


**Table 4.2** Electrical Input Operating Voltages

Power Supply Rating	Input Operating Voltage
All Models	200 V to 230 V Nominal (180 V Min. to 253 V Max.), 50 Hz or 60 Hz, Single Phase
	24 VDC, 2.5 A

**Table 4.3** Input Current and Fuse Specifications


Model	Power	Current Rating
20 kHz	2200 W	14 A Max. @ 200 V / 15 A Fuse

NOTICE	
	High duty cycles require additional cooling for the converter. For information on converter cooling refer to <a href="#">5.6 Converter Cooling</a> in <a href="#">Chapter 5: Installation and Setup</a> .

NOTICE	
	System average power must be limited to the specified continuous maximum. Duty cycle for each power and frequency is 1 second on and 2.4 seconds off.

## 4.2 Physical Description

This section describes the physical dimensions of the DCX 222 RM SIG Power Supply.

NOTICE	
	Dimensions are nominal.

**Table 4.4** Dimensions and Weights of DCX 222 RM SIG Power Supply

Size	Width	Height	Depth	Weight
Medium	142 mm	128 mm	560 mm	5.4 kg

For detailed dimensional information refer to [Chapter 5: Installation and Setup](#).

## 4.3 EU Declaration of Conformity

Figure 4.1 EU Declaration of Conformity

**EU DECLARATION OF CONFORMITY**

CE

We, the manufacturer

**BRANSON ULTRASONICS CORPORATION**  
120 Park Ridge Rd.  
Brookfield, CT 06804  
USA

represented in the community by

BRANSON ULTRASONICS, a.s.  
Piestanska 1202  
91501 Nove Mesto nad Vahom  
Slovak Republic

expressly declare under our sole responsibility that the following electrical equipment product:

Ultrasonic Assembly System consisting of an Ultrasonic Power Supply, model:

0.80 DCX(S, A, f-EIP, f-DP or f-pfn) 40 RACKMT 1.50 DCX(S, A, f-EIP, f-DP or f-pfn) 30 RACKMT 1.25 DCX(S, A, f-EIP, f-DP or f-pfn) 20 RACKMT 2.50 DCX(S, A, f-EIP, f-DP or f-pfn) 20 RACKMT 4.00 DCX(S, A, f-EIP, f-DP or f-pfn) 20 RACKMT DCX RM 222 STD DCX RM 240 STD DCX RM 222 B DCX RM 240 B DCX RM 480 STD DCX RM 315 STD DCX RM 211 STD DCX RM 480 B DCX RM 315 B DCX RM 211 B P/S 2.20 DCX STD 20 SIG	0.40DCX(s, v, a, f-dp, f-eip or f-pfn)40(VRT, V, H or HOR) 0.80DCX(s, v, a, f-dp, f-eip or f-pfn)40(VRT, V, H or HOR) 0.75DCX(s, v, a, f-dp, f-eip or f-pfn)30(VRT, V, H or HOR) 1.50DCX(s, v, a, f-dp, f-eip or f-pfn)30(VRT, V, H or HOR) 1.25DCX(s, v, a, f-dp, f-eip or f-pfn)20(VRT, V, H or HOR) 2.50DCX(S+, s, v, a, f-dp, f-eip or f-pfn)20(VRT, V, H or HOR) 4.00DCX(S+, s, v, a, f-dp, f-eip or f-pfn)20(VRT, V, H or HOR) 4.00DCXs20HD -V P/S 0.8 DCX S HD 40 VRT 1.50 DCX-S HD 30 (HOR or VRT) 1.50 DCX-S HD 30 VRT 4.00DCXs20HD -H P/S 0.8 DCX S HD 40 HOR P/S 4.0KW 20KHZ DCX S LIM RES 1.6DCX(a, f-dp, f-eip or f-pfn)40(B2H or B2V)
---	---


used with converter model: CR-20S, CR-20C, CH-20C, CS-20S, CS-20C, CR-30, CR-30C, CH-30, CH-30C, CS-30S, CS-30C, CR-40C, 4TH, 4TP or 932, and associated cables.

in the state in which it was placed on the market, fulfills all the relevant provisions and their amendments of:

Low Voltage Directive **2014/35/EU**  
EMC Directive **2014/30/EU**  
RoHS Directive **2011/65/EU**

The object of this declaration is in conformity with relevant Union harmonization legislation. The electrical equipment product, to which this declaration relates, is in conformity with the following standards:

EN 61010-1:2010+A1:2019  
EN 55011:2016/A11:2020  
EN 61000-6-2:2005/AC:2005

  
Luis Benavides  
 Luis Benavides (Feb 17, 2026 14:02:32 CST)  
 Director of Engineering, Systems / Product Safety Officer

Brookfield, CT, USA

## 4.4 UK Declaration of Conformity

Figure 4.2 UK Declaration of Conformity



### UK DECLARATION OF CONFORMITY

We, the manufacturer

**BRANSON ULTRASONICS CORPORATION**

120 Park Ridge Rd.  
Brookfield, CT 06804  
USA

expressly declare under our sole responsibility that the following electrical equipment product:

Ultrasonic Assembly System consisting of an Ultrasonic Power Supply, model:

0.80 DCX(S, A, f-EIP, f-DP or f-pfn) 40 RACKMT	0.40DCX(s, v, a, f-dp, f-eip or f-pfn)40(VRT, V, H or HOR)
1.50 DCX(S, A, f-EIP, f-DP or f-pfn) 30 RACKMT	0.80DCX(s, v, a, f-dp, f-eip or f-pfn)40(VRT, V, H or HOR)
1.25 DCX(S, A, f-EIP, f-DP or f-pfn) 20 RACKMT	0.75DCX(s, v, a, f-dp, f-eip or f-pfn)30(VRT, V, H or HOR)
2.50 DCX(S, A, f-EIP, f-DP or f-pfn) 20 RACKMT	1.50DCX(s, v, a, f-dp, f-eip or f-pfn)30(VRT, V, H or HOR)
4.00 DCX(S, A, f-EIP, f-DP or f-pfn) 20 RACKMT	1.25DCX(s, v, a, f-dp, f-eip or f-pfn)20(VRT, V, H or HOR)
DCX RM 222 STD	2.50DCX(S+, s, v, a, f-dp, f-eip or f-pfn)20(VRT, V, H or HOR)
DCX RM 240 STD	4.00DCX(S+, s, v, a, f-dp, f-eip or f-pfn)20(VRT, V, H or HOR)
DCX RM 222 B	4.00DCXs20HD -V
DCX RM 240 B	P/S 0.8 DCX S HD 40 VRT
DCX RM 480 STD	1.50 DCX-S HD 30 (HOR or VRT)
DCX RM 315 STD	1.50 DCX-S HD 30 VRT
DCX RM 211 STD	4.00DCXs20HD -H
DCX RM 480 B	P/S 0.8 DCX S HD 40 HOR
DCX RM 315 B	P/S 4.0KW 20KHZ DCX S LIM RES
DCX RM 211 B	1.6DCX(a, f-dp, f-eip or f-pfn)40(B2H or B2V)
P/S 2.20 DCX STD 20 SIG	

used with converter model: CR-20S, CR-20C, CH-20C, CS-20S, CS-20C, CR-30, CR-30C, CH-30, CH-30C, CS-30S, CS-30C, CR-40C, 4TH, 4TP or 932, and associated cables.

in the state in which it was placed on the market, fulfills all the relevant provisions and their amendments of:

Electrical Equipment (Safety) Regulations **2016**  
Electromagnetic Compatibility Regulations **2016**  
Restriction of the Use of Certain Hazardous Substances in Electrical and Electronic Equipment Regulations **2012**.

The electrical equipment product, to which this declaration relates, is in conformity with the following designated standards:

EN 61010-1:2010+A1:2019  
EN 55011:2016/A11:2020  
EN 61000-6-2:2005/AC:2005

Brookfield, CT, USA

*Luis Benavides*

Luis Benavides (Feb 17, 2026 14:02:48 CST)

Director of Engineering, Systems / Product Safety Officer

---


## **Chapter 5: Installation and Setup**

---

<b>5.1</b>	<b>About Installation . . . . .</b>	<b>38</b>
<b>5.2</b>	<b>Installation Requirements . . . . .</b>	<b>39</b>
<b>5.3</b>	<b>Installation Steps . . . . .</b>	<b>42</b>
<b>5.4</b>	<b>Power Supply Configuration . . . . .</b>	<b>52</b>
<b>5.5</b>	<b>Assembling the Acoustic Stack . . . . .</b>	<b>54</b>
<b>5.6</b>	<b>Converter Cooling . . . . .</b>	<b>57</b>
<b>5.7</b>	<b>Testing the Installation . . . . .</b>	<b>58</b>
<b>5.8</b>	<b>Still Need Help? . . . . .</b>	<b>59</b>

## 5.1 About Installation

This chapter is intended to help the installer with the basic installation and setup of your new DCX 222 RM SIG Power Supply.

<b>CAUTION</b>	<b>Heavy Object</b>
	The power supply, and related components are heavy. Handling, unpacking, and installation may require the assistance of a colleague or the use of lifting platforms or hoists.

International safety-related labels are found on the power supply. Those that are of importance during installation of the system are identified in [Figure 1.1 Safety-related Labels found on the DCX 222 RM SIG Power Supply](#) and [Figure 1.2 Safety-related Labels found on the DCX 222 RM SIG Power Supply \(back\)](#).

## 5.2 Installation Requirements


This section covers the location requirements, mounting options, power supply dimensions, environmental requirements, and electrical requirements, to help you plan and execute your installation successfully.

### 5.2.1 Installing the DCX 222 RM SIG Power Supply Drawers in a Customer Rack

The power supply units can be installed in any rack complying with the 19" industrial standard.

For successful installation in a rack, the respective demands on the electric and cooling system have to be met.

- If multiple drawers are to be installed in a rack we recommend to provide three phase power to the rack in order to provide each drawer with a dedicated supply and one phase to each drawer
- Particular care has to be taken that the heat generated during operation is dissipated. The heat generated depends on the power output by the module and the ambient conditions
- The heat sink of the module is mounted on the right. Make sure that the cooling device is mounted in a way allowing the cooling air to pass freely on this side
- For each group of four power supply modules installed one cooling drawer is required. The cooling drawers must be installed directly under the power supplies in order to ensure sufficient cooling
- In case a filter element is used to clean the intake air, regular inspection and cleaning of the filter depending on the ambient conditions is required to maintain the airflow volume
- To prevent thermal overload, the system is protected by thermostats which are reset automatically after cooling down

NOTICE	
	<p>Three 105 CFM fans must be placed directly underneath each unit for cooling.</p>

### 5.2.2 Location

The power supply should be accessible for parameter changes and settings. The power supply should be located in an area away from radiators or heating vents.

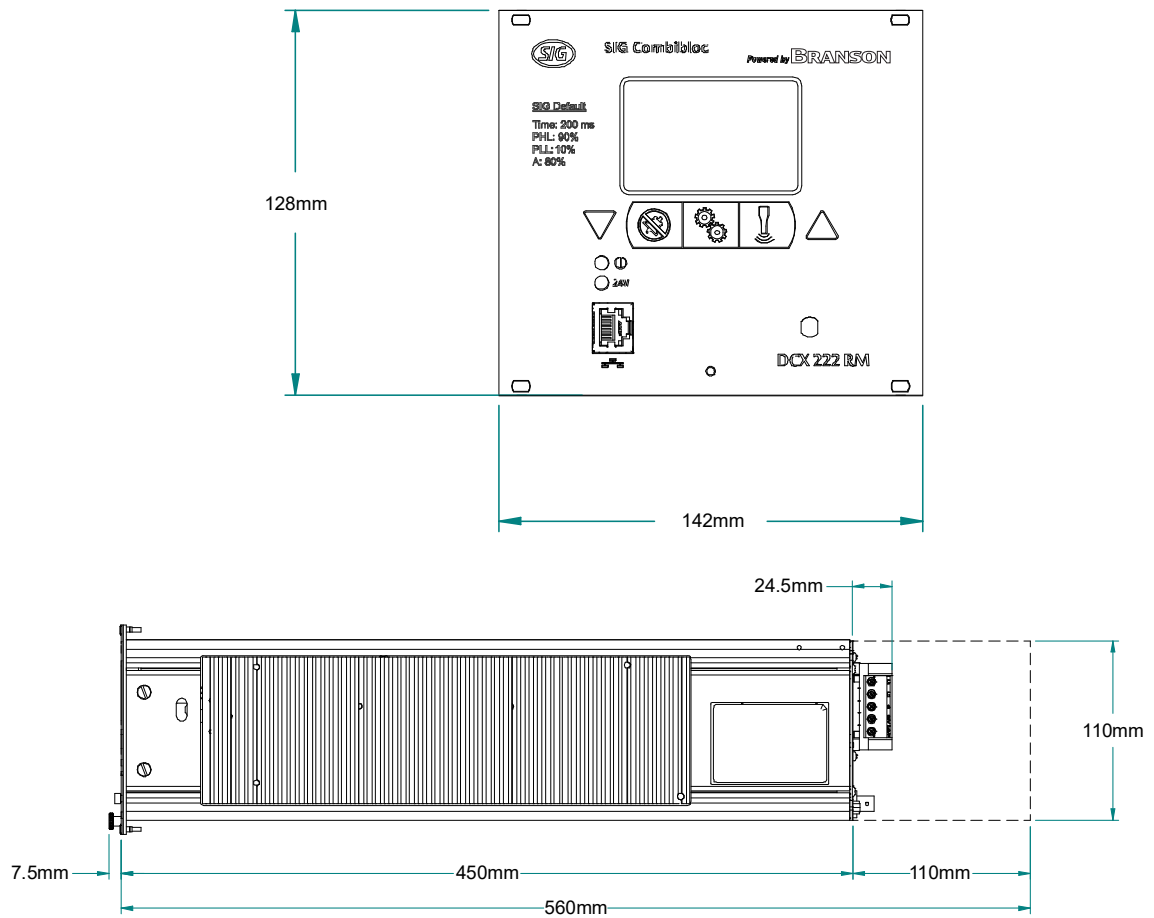
The DCX 222 RM SIG Power Supply must not be positioned so that is difficult to plug in or unplug the main power plug.

### 5.2.3 Dimensions

Refer to the illustrations on the pages that follow for dimensional drawings. All dimensions are approximate and may vary slightly:

[Figure 5.1 DCX 222 RM SIG Power Supply Dimensional Drawing \(Medium\)](#)

**Figure 5.1** DCX 222 RM SIG Power Supply Dimensional Drawing (Medium)



## 5.2.4 Environmental Requirements

Verify the DCX 222 RM SIG Power Supply is operated in an environment that meets the temperature and humidity requirements indicated in [Table 5.1 Environmental Requirements](#).

**Table 5.1** Environmental Requirements

Environmental Condition	Acceptable Range
Ambient Operating Temperature	+5° C to +50° C
Operating Altitude	2000 m
Humidity	Maximum 95%, non-condensing
IP Rating	20 Protected against solid objects larger than 12.5 mm; no protection against water.
Pollution Degree	2 Only non-conductive pollution occurs; temporary conductivity caused by condensation may be expected.
Overvoltage Category	II Equipment intended to be supplied from the building wiring.

## 5.2.5 Electrical Input Power Ratings

Connect the power supply to a single-phase, grounded, 3-wire, 50 Hz or 60 Hz 200 V to 230 V power source. [Table 5.2 Input Current and Circuit Breaker Specifications](#) lists the current and fuse ratings for the various models.

**Table 5.2** Input Current and Circuit Breaker Specifications

Model	Power	Current Rating
20 kHz	2200 W	14 A Max. @ 200 V / 15 A Breaker


## 5.2.6 Pneumatic Requirements

Your welding system may require a cooling air stream for the converters. In continuous operations, or applications with longer duty cycles, it may be necessary to cool the horn as well as the converter.

Typically 80 cubic feet (2.26 m<sup>3</sup>) per hour of clean, dry, compressed air are required to cool most welding operations.

To verify the 80 cubic feet (2.26 m<sup>3</sup>) per hour cooling air stream required for your welding system, refer to [5.6 Converter Cooling](#).

## 5.3 Installation Steps

WARNING	High Voltage Hazard
	<p>To prevent the possibility of an electrical shock:</p> <ul style="list-style-type: none"> <li>• Ensure the power source is disconnected before beginning to work on line connections</li> <li>• Ensure the power switch on the back of the unit is in the OFF position before making any electrical connections</li> <li>• Always plug the power supply into a grounded power source</li> <li>• To prevent the possibility of an electrical shock, ground the power supply by securing an AWG #14 grounded conductor to the ground screw located next to the air outlet</li> <li>• Ensure power supply installation is performed by qualified personnel and in accordance with local standards and regulations</li> </ul>


### Basic installation notes:

- To avoid problems associated with EMI, you should route high power lines (AC and Ultrasonic RF) away from low power lines (controls signals)
- You should consider future troubleshooting and repair when installing all wiring. All wiring should be either color coded or tagged with industrial wire tags
- The minimum cable bend radius is 5 times the cable outer diameter for RF cables
- The minimum cable bend radius is 10 times the cable outer diameter for user I/O & Ethernet cables
- Ground wires should not be shared with other equipment
- All inductive coils must be suppressed with appropriate devices, such as diodes or RC networks

### 5.3.1 Mount the Power Supply

The cable lengths are limited based on the operating frequency of the welding system. Performance and results can suffer if the RF cable is crushed, pinched, damaged or modified. Contact your Branson Representative if you have special cable requirements.

Do not place the power supply on the floor or in other locations that will allow dust, dirt or contaminants to be drawn into the power supply.

NOTICE	
	<p>Do not block exhaust and intake air circulation, which is needed to maintain a safe operating temperature.</p>


For dimensional drawings of the DCX 222 RM SIG Power Supply, see [Figure 5.1 DCX 222 RM SIG Power Supply Dimensional Drawing \(Medium\)](#).

### 5.3.2 Mounting Considerations

In addition to the considerations mentioned above, the LCD's viewing angle should be taken into account when selecting a location for your DCX 222 RM SIG Power Supply. The LCD is designed to be viewed from the top. Please refer to [Figure 5.2 LCD Viewing Angle](#) below when selecting a location for your DCX 222 RM SIG Power Supply.

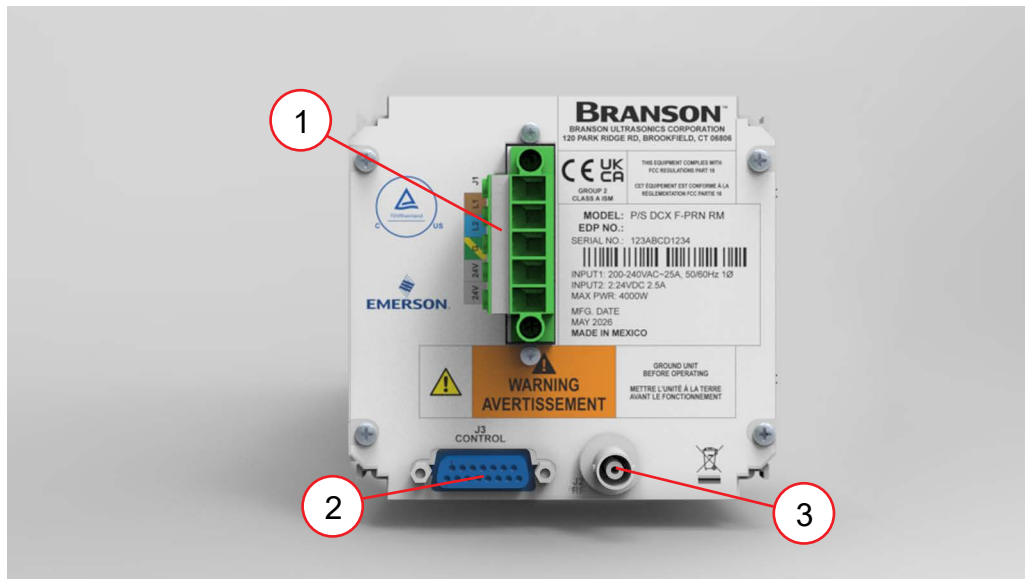
**Figure 5.2** LCD Viewing Angle



NOTICE	
	<p>Optimal viewing angle is 25° above the normal to the display (indicated by 0°).</p>

## 5.3.3 Electrical Connections

**Figure 5.3** DCX 222 RM SIG Power Supply Connections




**Table 5.3** DCX 222 RM SIG Power Supply Connections

Item	Description
1	Line Input Connector
2	User I/O Connector
3	RF Connector

## 5.3.4 User I/O Connections

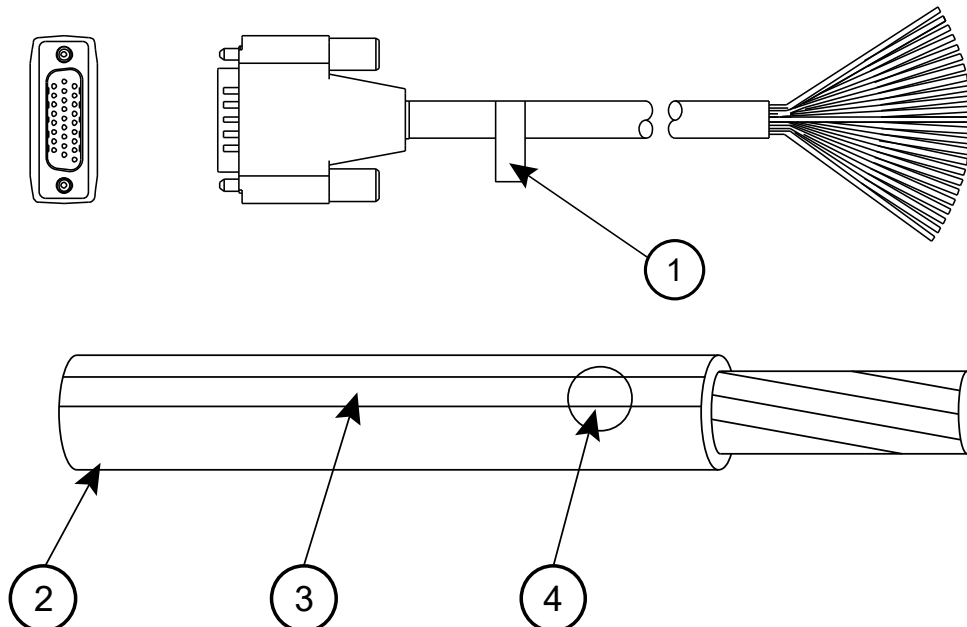
The user I/O is a standard interface for automation, provided on the power supply. It provides the ability to make your own interface for your automation, actuator interface, special control, or reporting needs. The interface cable has a DB15 male connector on one end, and wires on the other end. Pins are wired to ICEA standard color code (see [Figure 5.4](#) and [Table 5.4](#)).

NOTICE	
	<p>Ensure all unused wires are properly isolated. Failure to do so may result in a power supply malfunction.</p>

Digital I/O functions can be configured to either active-high or active-low using the DCX 222 RM SIG Power Supply web page interface. [Table 5.5](#) to [Table 5.8](#) list the input and output functions available on the DCX 222 RM SIG Power Supply. See [Table 5.4](#) for the user I/O pin assignments. [Figure 5.5](#) and [Figure 5.6](#) show typical wiring examples.

**Figure 5.4** User I/O Cable Identification and Wire Color Diagram

User I/O Cable  
 Stripped Jacket one end,  
 DB15 male connector other end  
 (cable length as ordered)



Item	Description	Item	Description
1	Part number	2	Insulation
3	Stripe	4	Dot

## 5.3.5 User I/O Cable Pin Assignments

**Table 5.4** User I/O Cable Pin Assignments

PIN	Input/Output Function	Signal Type	Signal Range	Color	
				ISO	IEC
1	+Peak Power Limit	Digital Output	24 V +/- 10%, 25 mA	White	Black
2	Overload Inverted (Ready)	Digital Output	24 V +/- 10%, 25 mA	Brown	Brown
3	GND	24 V Ground	0 V External	Green	Red
4	Overload	Digital Output	24 V +/- 10%, 25 mA	Yellow	Orange
5	External Start	Digital Input	24 V +/- 10%, 25 mA	Gray	Yellow
6	External Seek			Pink	Green
7	+10 V	10 V Reference	10 V	Blue	Blue
8	GND	24 V Ground	0 V External	Red	Violet
9	Sonics Active	Digital Output	24 V +/- 10%, 25 mA	Black	Gray
10	Power Out	Analog Output	0 V to 10 V	Violet	White
11	+24 V	24 V Source	24 V External	Gray/ Pink	White/ Black
12	-Peak Power Limit	Digital Output	24 V +/- 10%, 25 mA	Red/ Blue	White/ Brown
13	External Reset	Digital Input	24 V +/- 10%, 25 mA	White/ Green	White/ Red
14	Amplitude Out	Analog Output	0 V to 10 V	Brown/ Green	White/ Orange
15	Amplitude In	Analog Input	-8 V to +10 V	White/ Yellow	White/ Yellow

### 5.3.6 Available Digital Input Functions

**Table 5.5** Available Digital Input Functions

Function	Description
External Reset	Resets alarm conditions.
External Seek	Activates ultrasonic energy at 10% amplitude for the purpose of finding the ultrasonic stack resonant frequency.
External Start	Activates ultrasonic energy at the currently set amplitude. <div style="background-color: #003366; color: white; padding: 2px;"><b>NOTICE</b></div> DCX 222 RM SIG Power Supply must be in ready mode before External Start.

### 5.3.7 Available Digital Output Functions

**Table 5.6** Available Digital Output Functions

Function	Description
Overload Inverted	Indicates the system is ready.
Sonics Active	Indicates sonics are active.
Overload	Indicates an overload alarm has occurred.
+Peak Power Limit	Indicates the weld has exceeded the maximum peak power set.
-Peak Power Limit	Indicates the weld has not reached the minimum peak power set.

### 5.3.8 Available Analog Input Functions

**Table 5.7** Available Analog Input Functions

Function	Description	Valid Range
Amplitude In	Controls the amplitude of ultrasonic energy that will be delivered by the power supply.	-8 V to +10 V (10% to 100%)

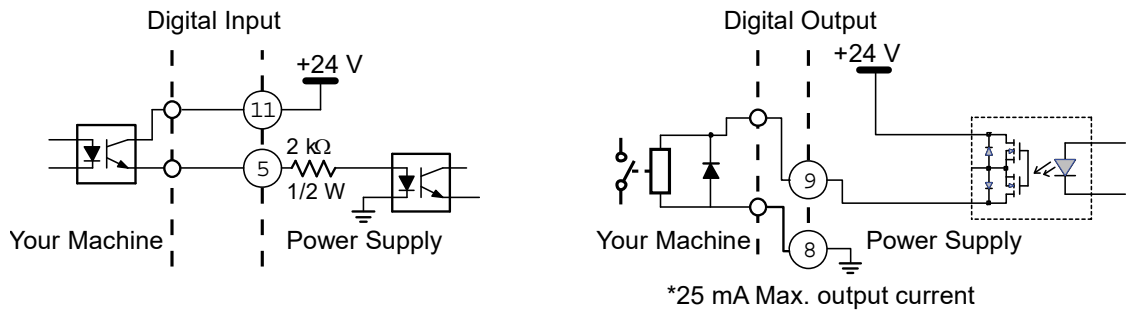
## 5.3.9 Available Analog Output Functions

**Table 5.8** Available Analog Output Functions

Function	Description	Valid Range
Power Out	Provides a 0 V to 10 V output signal proportional to ultrasonic power output (0% to 100%).	0 V to 10 V (0% to 100%)
Amplitude Out	Provides a 0 V to 10 V output signal proportional to amplitude (0% to 100%).	0 V to 10 V (0% to 100%)

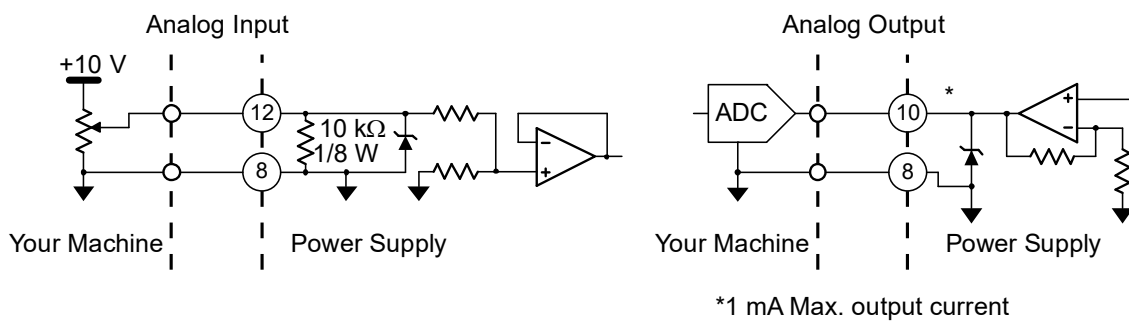
## 5.3.10 Typical Digital I/O Wiring Examples

**Figure 5.5** Typical Digital I/O Wiring Examples



## 5.3.11 Typical Analog I/O Wiring Examples


**Figure 5.6** Typical Analog I/O Wiring Examples





## 5.3.12 Output Power (RF Cable) Connection

Ultrasonic energy is delivered to the MHV connector on the power supply, which is then transmitted to the converter via the RF cable. The RF connector is located on the rear panel of the power supply.

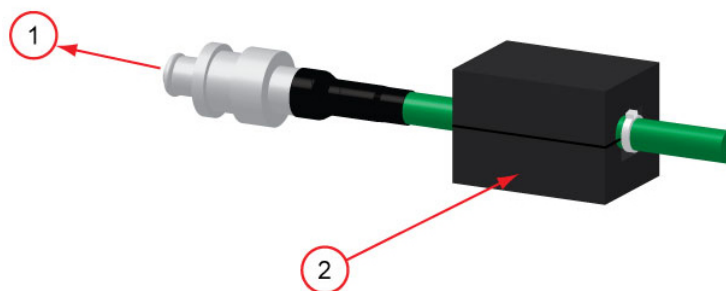
To reduce electromagnetic interference (EMI), RF cables are equipped with a ferrite core (plastic case) on one end. This end is meant to be connected to the power supply.

WARNING	High Voltage Hazard
	<p>Operating the System with the RF Cable disconnected or damaged can present an electrical shock hazard.</p>

WARNING	High Voltage Hazard
	<p>To avoid the possibility of electrical shock, converters need to be properly grounded.</p>

NOTICE	
	<p>To avoid the possibility of EMI interference, ensure the RF connection to the power supply is made with the cable end that has the ferrite core box attached (see <a href="#">Figure 5.7 RF Cable Connection</a>).</p>


**Figure 5.7** RF Cable Connection





**Table 5.9** RF Cable Connection

Item	Description
1	To Power Supply
2	Ferrite Core Box

## 5.3.13 Input Power Connection

WARNING	High Voltage Hazard
	<p>Ensure all electrical power is off when wiring input power to your DCX 222 RM SIG Power Supply power connector.</p> <p>To prevent the possibility of an electrical shock, ground the power supply by securing an AWG #14 grounded conductor to the ground screw located next to the air outlet</p>

WARNING	High Voltage Hazard
	<p>If miss-wired, the power supply can present an electrical shock hazard.</p>

NOTICE	
	<p>The power supply can be permanently damaged if it is connected to the incorrect line voltage, or if the connection is mis-wired.</p>

Use the following procedure to connect the power supply to a 24 VDC 2.5A external power supply and to a single-phase, grounded 3-wire, 50 Hz or 60 Hz 200 V to 230 V power source. The 24 VDC power supply must be safety certified and agency approved.

**Table 5.10** Input Power Connection

Step	Action
1	Detach the connector block on the back of the power supply.
2	Use two properly sized wires (according to local standards) to connect a 24 VDC 2.5A power supply as shown on <a href="#">Figure 5.3 DCX 222 RM SIG Power Supply Connections</a> .
3	Use three properly sized wires (AWG #12, 2.5 mm or according to local standards) to connect the line 1, line 2, and ground to the connector block as shown on <a href="#">Figure 5.3 DCX 222 RM SIG Power Supply Connections</a> . Choose wires according to the current rating as specified in <a href="#">Table 5.2 Input Current and Circuit Breaker Specifications</a> and on the label located on the back of the unit. Be sure to use agency approved wiring and use sleeving or tubing on each wire for double insulation.
4	Secure an AWG #12 grounded conductor to the ground screw located next to the air outlet.

**Table 5.10** Input Power Connection

Step	Action
5	Connect the converter-booster-horn stack to the power supply using the RF cable. See <a href="#">5.3.12 Output Power (RF Cable) Connection</a> .
6	Ensure the power of the unit is disconnected. Plug the connector block back into the power supply. Tighten the two securing screws.
7	Connect the power supply to a single-phase, grounded, 3-wire, 50 Hz or 60 Hz 200 V to 230 V power source.

## 5.4 Power Supply Configuration

### 5.4.1 Selecting the Alarm Mode

The DCX 222 RM SIG Power Supply activates ultrasonic power after receiving an External Start signal. Ultrasonic power remains on until you turn off the power supply or the External Start signal. The DCX 222 RM SIG Power Supply response to alarm conditions can be configured to operate in one of two modes:

**Table 5.11** Selecting the Alarm Mode

Name	Description
Latching	In this mode the DCX 222 RM SIG Power Supply requires alarm conditions to be reset before a new weld cycle can begin. To reset alarm conditions while in this mode, either press the front panel Reset key or send an External Reset signal using the user I/O connector.
Non-Latching	In this mode the DCX 222 RM SIG Power Supply does not require alarm conditions to be reset, and new weld cycle can begin upon receiving an External Start signal.

The alarm mode is factory-set to non-latching. For instruction on how to change the alarm mode refer to [7.5 Configuring the Power Supply Registers](#) in [Chapter 7: Operation](#) and to your DCX Series Web Page Interface Instruction Manual (4000843).

### 5.4.2 Configuring the Power Supply

Certain power supply configurations can be modified from the factory setting if needed. Although not usually requiring modifications from the factory setting, the following features are selectable:


**Table 5.12** Configuring the Power Supply

Name	Description
Amplitude control	Allows for varying the amplitude (10% to 100%) using the front panel LCD, the web page interface, or by way of external controls (analog signal applied through the user I/O analog input).
Latching Alarms	Provides an option for selecting the power supply alarms to be latching (reset required) or non-latching (reset by reapplying the start signal).
Mode	Allows for selecting the weld mode from the different available options: Continuous, Time (s), and Energy (J).
Start Ramp Time	Provides a selection for different start ramp times. This controls how fast the amplitude of the horn rises from zero to the currently set amplitude. Long ramp times may be useful when using large horns or high gain stacks.
End of Weld Frequency Store	Provides an option for selecting if the stack frequency is stored at the end of each weld cycle.
Seek Ramp Time	Provides a selection for different power supply seek ramp times.


**Table 5.12** Configuring the Power Supply


Name	Description
Timed Seek	Provides an option for monitoring, and storing the operating frequency at timed intervals (60 seconds). Periodic frequency seeks may be helpful when welder is not used for long periods of time. Seeks are timed from the moment sonics was last activated.
Seek Time	Provides an option for selecting seek duration.
Frequency Offset	Allows for varying the start frequency by way of external controls (analog signal applied though the user I/O analog input) or setting a fixed value using the web page interface. This is useful for certain applications, where the force imparted on the fixture or anvil causes a frequency shift in the stack's operation.


For instruction on how to change the power supply settings refer to [7.5 Configuring the Power Supply Registers](#) in [Chapter 7: Operation](#) and to your DCX 222 RM SIG Power Supply Web Page Interface Instruction Manual (4000843).

NOTICE	
	Consult with Branson before changing any default factory setting.

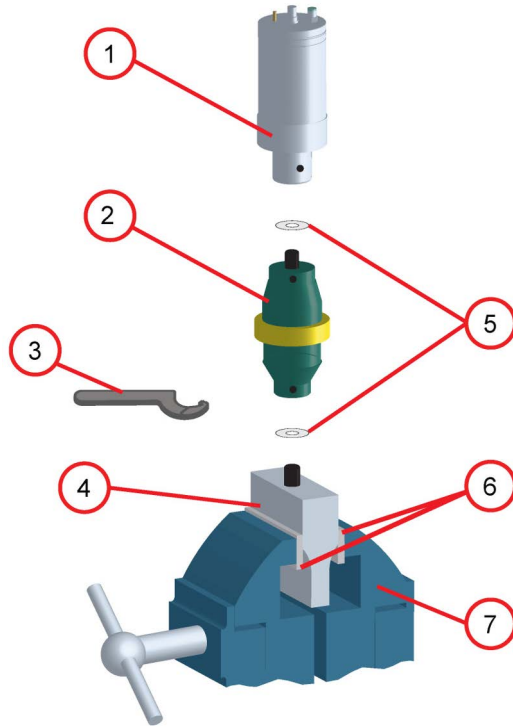
## 5.5 Assembling the Acoustic Stack

CAUTION	General Warning
	<p>The following procedure must be performed by a setup person. If necessary, secure the largest portion of a square or rectangular horn in a soft jawed vise. NEVER attempt to assemble or remove a horn by holding the converter housing or the booster clamp ring in a vise.</p>

CAUTION	General Warning
	<p>Do not use silicone grease with Mylar<sup>®</sup> plastic film washers. Use only 1 (one) Mylar<sup>®</sup> plastic film washer of the correct inside and outside diameters at each interface.</p>

NOTICE	
	<p>The use of a Branson torque wrench or the equivalent is recommended. EDP 101-063-787 for 20 kHz systems.</p>

**Figure 5.8** Assembling the Acoustic Stack



**Table 5.13** Acoustic Stack Description

Item	Description
1	Converter
2	Booster
3	Spanner (provided)
4	Horn
5	See stack assembly procedure
6	Vise Jaw protectors (aluminum or soft metal)
7	Vise

**Table 5.14** Stack Torque Values

Frequency	Torque
20 kHz	Converter–Booster: 50 N·m Booster–Horn: 75 N·m

**Table 5.15** Tools

Tool	EDP Number
20 kHz Torque Wrench Kit	101-063-787
20 kHz Spanner Wrench	101-118-039
Mylar <sup>®</sup> Plastic Film Washers (20 kHz)	100-063-357

## 5.5.1 For a 20 kHz System

**Table 5.16** 20 kHz System

Step	Action
1	Ensure that the mating surfaces of the converter, booster, and horn are clean, and that the threaded holes are free of foreign material.
2	Install a single Mylar <sup>®</sup> plastic film washer (matching the size of the washer to the stud) to each interface.
3	Assemble the converter to the booster and the booster to the horn.
4	Torque to 50 N·m for the converter–booster and 75 N·m for the booster–horn.

## 5.6 Converter Cooling

Converter performance and reliability can be adversely affected if the converter ceramics are subjected to temperatures above 140° F (60° C). The converter front driver temperature should not exceed 122° F (50° C).

To prolong converter life and maintain a high degree of system reliability, the converter should be cooled with clean, dry, compressed air, particularly if your application calls for continuous ultrasonic operation.

Use one of the following procedures to determine if a converter is operating close to the maximum allowable temperature. Check converter temperature immediately after substantial machine operation and without power applied to the horn.

- Press a pyrometer probe (or similar temperature measuring device) against the front driver of the converter assembly. Wait for the probe to reach the temperature of the shell. If the temperature is 120°F (49° C) or higher, the converter requires a cooling air stream
- If a temperature measuring device is unavailable, use your hand to feel the shell of the converter. If the converter is hot to touch, the converter requires a cooling air stream

High duty cycles require additional cooling for the converter. System average power must be limited to the specified continuous maximum. Higher peak power, up to the maximum acceptable power limit, with an on time of up to 10 seconds may be obtained, if appropriate off time ensures that, on average, the continuous duty maximum power is not exceeded.

**Table 5.17** Continuous Duty Max. Power & Full Power Duty Cycle

Model	Power	Continuous Duty. Max. Power	Full Power Duty Cycles
20 kHz	2200 W	660 W	1 s on 2.4 s off (30% Duty Cycle)

If converter cooling is required, use the following steps:

**Table 5.18** Converter Cooling Procedure

Step	Action
1	Start with a 50 psi (345 kPa) air source or higher from a 0.06 in (1.5 mm) I.D. orifice
2	Perform a run of welding operations.
3	Immediately after completing the welding run, check the converter temperature.
4	If the converter is still too hot, increase the diameter of the orifice in small increments until the temperature falls within the ranges in the chart.

A 0.06 in (1.5 mm) orifice at 50 psi (345 kPa) will result in a reading of 80 ft<sup>3</sup> (2.26 m<sup>3</sup>) per hour. This should be sufficient to cool most operations requiring a cooling air stream. In continuous welding operations, or applications with longer duty cycles, it may be necessary to cool the horn as well as the converter. Horns may require cooling because of the heat transfer from contacting the work piece.

## 5.7 Testing the Installation

To test the power supply follow the procedure described in [7.8 Ultrasonics Test Procedure](#) in [Chapter 7: Operation](#).

## 5.8 Still Need Help?

Branson is pleased that you chose our product and we are here for you! If you need parts or technical assistance with your DCX 222 RM SIG Power Supply system, call your local Branson representative. Please refer to [1.3 How to Contact Branson](#) for a list of Branson key contacts.



---


# **Chapter 6: Converters and Boosters**

---

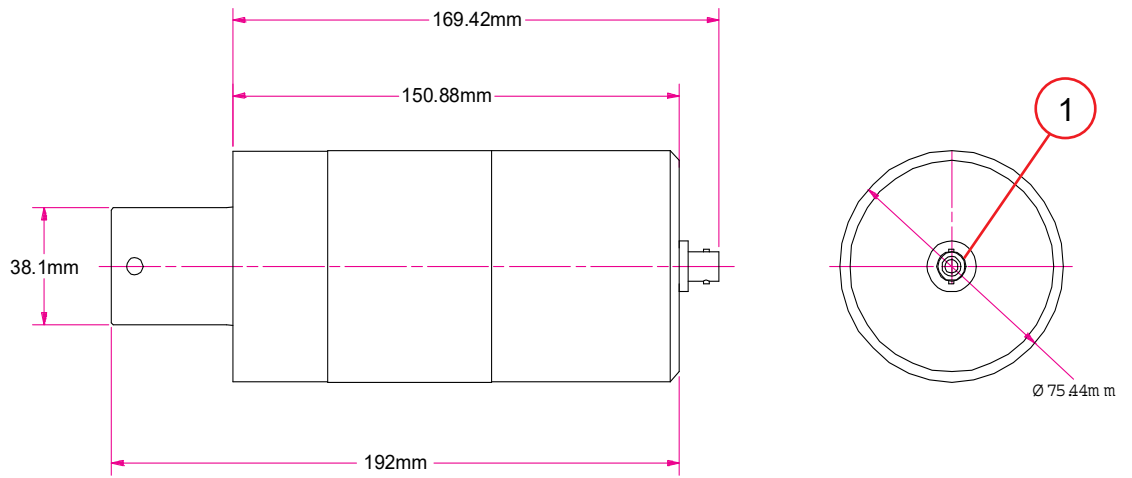
**6.1 Converters and Boosters. . . . .62**

## 6.1 Converters and Boosters

A variety of converters and boosters available for use with the DCX 222 RM SIG Power Supply are illustrated in the following pages.

<b>WARNING</b>	<b>High Voltage Hazard</b>
	To avoid the possibility of electrical shock, converters need to be properly grounded.

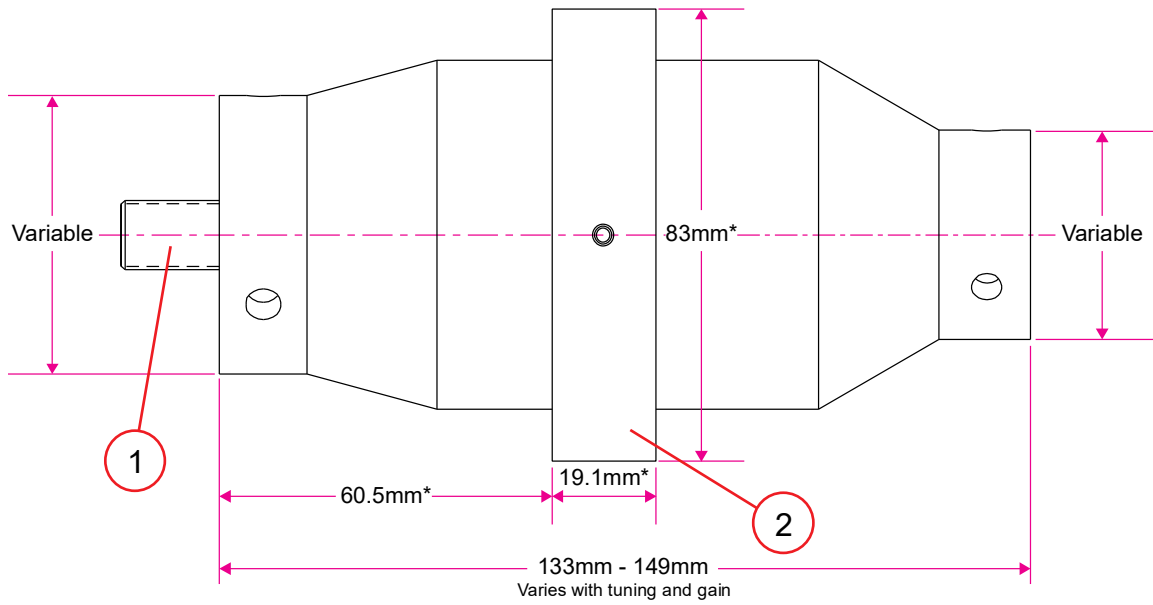
**Figure 6.1** 20 kHz 932 AS Converter Dimensions



**Table 6.1** 20 kHz CH-20S Converter Dimensions

Item	Description
1	MHV Connector

**Figure 6.2** 20 kHz Booster Dimensions

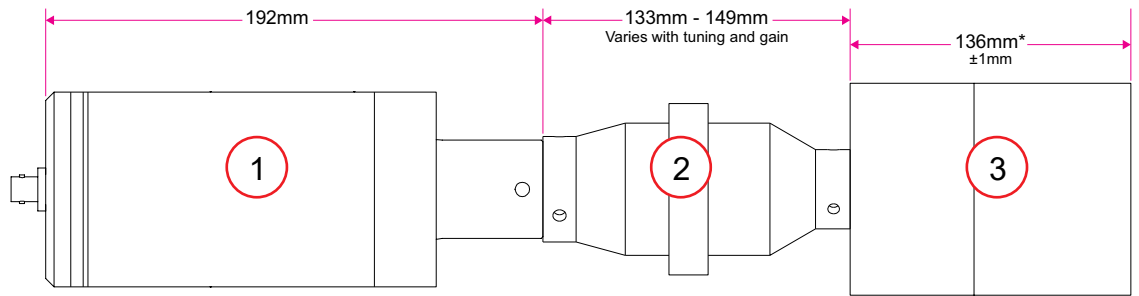


**Table 6.2** 20 kHz Booster Dimensions

Item	Description
1	1/2 - 20 x 1 - 1/4 stud (Ti boosters)
2	Grip Ring Diameter

\* These dimensions do not vary.

**Figure 6.3** 20 kHz Converter/Booster/Horn, Typical Dimensions



**Table 6.3** 20 kHz Converter/Booster/Horn, Typical Dimensions

Item	Description
1	Converter
2	Booster
3	One-half wavelength horn

\* Overall horn length can vary beyond these typical dimensions depending on the application.

## 6.1.1 Component Functional Description

### Ultrasonic Stack

#### Converter

The converter is mounted in the customer's automation as part of the ultrasonic stack. The ultrasonic electrical energy from the power supply is applied to the converter (sometimes called the transducer). This transforms the high frequency electrical oscillations into mechanical vibrations at the same frequency as the electrical oscillations. The heart of the converter are piezoelectric ceramic elements. When subjected to an alternating voltage, these elements alternately expand and contract, resulting in better than 90% conversion of electrical to mechanical energy.

#### Booster

It is important to be able to modify the horn face amplitude for successful ultrasonic assembly. The booster provides a means to modify the amplitude. It is designed to couple different ratios of ultrasonic energy to the horn, which will in turn increase or decrease the amplitude at the face of the horn. This is accomplished by varying the ratios of the masses of the input and output half sections of the booster.

The booster is a resonant half-wave section of aluminum or titanium. It is mounted between the converter and the horn, as part of the ultrasonic stack. It also provides a clamping point for rigid stack mounting.

#### Horn

The horn is selected or designed for a specific application. Each horn is tuned typically as a half-wave section that applies the necessary force and vibration uniformly to the parts to be assembled. It transfers ultrasonic vibrations from the converter to the workpiece. The horn is mounted to the booster as part of the ultrasonic stack.

Depending on their profile, horns are referred to as stepped, conical, exponential, bar, or catenoidal. The shape of the horn determines the amplitude at the face of the horn. Depending on the application, horns can be made from titanium alloys, aluminum, or steel. Titanium alloys are the best materials for horn fabrication due to their high level of strength and low loss. Aluminum horns are usually chrome- or nickel-plated or hard-coated to reduce wear. Steel horns are for low amplitude requiring hardness, such as ultrasonic insertion applications.

## **Solid Mount Boosters**

The solid mount booster is a one-half wave-length resonant section made exclusively of titanium. It is mounted between the converter and the horn, modifying the amplitude of vibration applied to the horn and providing a clamping point.

The solid mount booster is superior to prior versions in that deflection is minimized. This is the result of a redesigned clamp-ring which employs a metal-to-metal press fit rather than an O-ring assembly.

The advantage this booster offers is its improved rigidity. For continuous applications, this means more energy delivered to the product, while in plunge applications, improved alignment is possible. The solid mount provides improved positional alignment and will benefit continuous applications where high force, high side load, or high cycle rates are necessary. In plunge welding applications, overall deflection is reduced by an average of 0.0025 in. (0.064 mm) over a wide variety of materials, joint designs, and operating conditions. The results of this testing in combination with information drawn from field testing indicate that the solid mount will benefit plunge applications where precision alignment is necessary (such as staking, swaging, or insertion) or where concentricity/parallelism is critical.




---

## Chapter 7: Operation

---

<b>7.1</b>	<b>Setting Primary Parameters . . . . .</b>	<b>70</b>
<b>7.2</b>	<b>Setting Limits . . . . .</b>	<b>77</b>
<b>7.3</b>	<b>Setting the Amplitude . . . . .</b>	<b>83</b>
<b>7.4</b>	<b>Resetting the Power Supply Alarms . . . . .</b>	<b>86</b>
<b>7.5</b>	<b>Configuring the Power Supply Registers . . . . .</b>	<b>87</b>
<b>7.6</b>	<b>LCD Bar-Graph . . . . .</b>	<b>92</b>
<b>7.7</b>	<b>Web Page Interface . . . . .</b>	<b>94</b>
<b>7.8</b>	<b>Ultrasonics Test Procedure . . . . .</b>	<b>98</b>

## 7.1 Setting Primary Parameters


NOTICE	
	There is a 2 seconds power-up delay before system is in ready mode.

After analyzing your specific application, you can determine the Weld Mode to use to weld your parts. A Weld Mode is a set of parameters that governs the weld. (Contact the Branson Ultrasonics Applications Laboratory for more information on determining the best mode for welding your application). See [1.3 How to Contact Branson](#).

There are three Weld Modes to choose from Continuous, Time, and Energy modes. The following table describes each mode:

**Table 7.1** Summary of Weld Modes

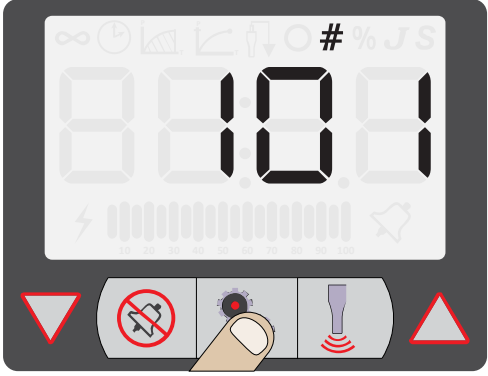
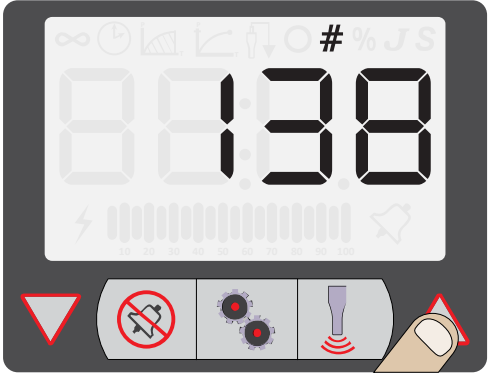
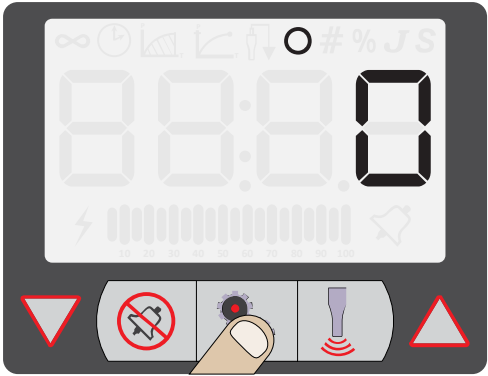
Weld Mode	Description
Continuous	On this mode, ultrasonic energy will be delivered continuously while the start signal is present.
Time	You select the length of time (in seconds) that ultrasonic energy will be transmitted to your parts.
Energy	You select the amount of energy (in Joules) that will be transmitted to your parts. (A Joule is one Watt-Second).

NOTICE	
	In these modes, cutoffs can be used as secondary controls.

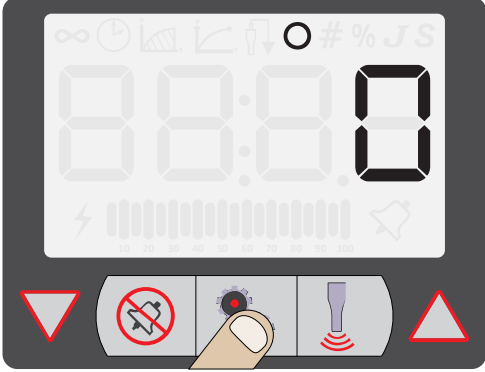

## 7.1.1 Selecting Continuous Mode

In this mode, ultrasonic energy will be delivered continuously while the start signal is present. Within Continuous Mode, you can also select several other parameters, ranging from afterburst to limits and cutoffs. For more information on setting the optional parameters within Continuous Mode, or any other welding mode, refer to the DCX Web Page Instruction Manual.

**Table 7.2** Selecting Continuous Mode

Step	Action	Reference
1	<p>Press the Configuration key until the number icon (#) appears on the LCD.</p> <p>The power supply will display register 101 at every power up.</p>	
2	<p>Press and release the Up/Down arrow keys to select register 138. For a detailed description of available registers refer to <a href="#">Table 7.18 Power Supply Registers</a>.</p>	
3	<p>Once you have reached register 138, press the Configuration key. The register value will be displayed; this is indicated by the circle icon.</p>	

**Table 7.2** Selecting Continuous Mode

Step	Action	Reference
4	Use the Up/Down arrow keys to select value 0 (Continuous mode), then press the Configuration key to confirm the selection.	 <p>The screenshot shows a control panel with a digital display showing '00:00'. Above the display are several icons, including an infinity symbol, a clock, a waveform, and a circle with a dot. Below the display is a battery level indicator and a star icon. At the bottom, there are four buttons: a left-pointing triangle, a button with a crossed-out lightning bolt, a button with a gear icon (being pressed by a finger), and a right-pointing triangle. A red lightning bolt icon is also visible on the right side of the panel.</p>
5	Continuous mode icon and amplitude value will be displayed.	 <p>The screenshot shows the same control panel as in step 4, but the digital display now shows '100'. The gear icon button is no longer being pressed. The infinity symbol icon at the top left of the display is now highlighted, indicating that continuous mode is selected.</p>



## 7.1.2 Selecting Time Mode

You can use Time Mode to select the length of time that ultrasonic energy is applied to your parts. Within Time Mode, you can also select several other parameters, ranging from afterburst to limits and cutoffs. For more information on setting the optional parameters within Time Mode, or any other welding mode, refer to the DCX Web Page Instruction Manual.

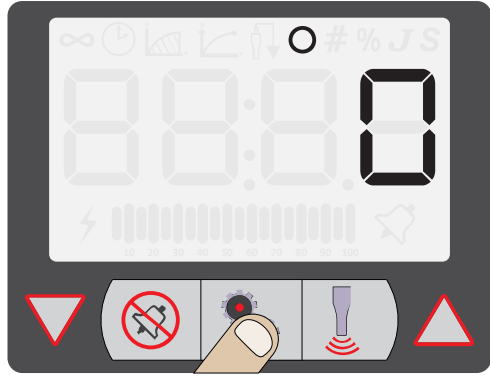
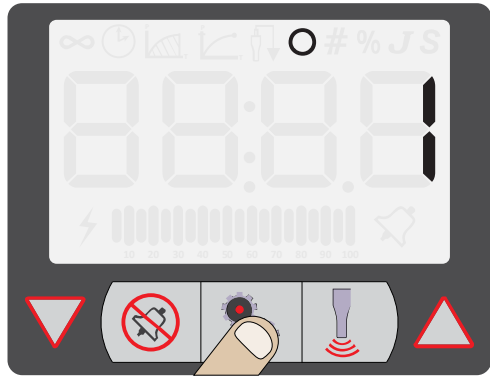
**Table 7.3** Time Mode Parameters

Parameter	Default	Max. Value	Min. Value
Time	0.200 seconds	30.00 seconds	00.01 seconds

**Table 7.4** Selecting Time Mode


Step	Action	Reference
1	<p>Press the Configuration key until the number icon (#) appears on the LCD.</p> <p>The power supply will display register 101 at every power up.</p>	 <p>The image shows a digital LCD display with the number '101' in the center. Above the number is a '#' icon. The display is surrounded by various control icons, including a power button, a left arrow, a right arrow, and a warning symbol. Below the display are four physical buttons: a left arrow, a button with a crossed-out wrench and screwdriver, a button with a gear, and a button with a lightbulb. A hand is shown pressing the gear button.</p>
2	<p>Press and release the Up/Down arrow keys to select register 138. For a detailed description of available registers refer to <a href="#">Table 7.18 Power Supply Registers</a>.</p>	 <p>The image shows the same digital LCD display as in step 1, but now the number '138' is displayed in the center. The '#' icon is still present above the number. A hand is shown pressing the right arrow button.</p>

**Table 7.4** Selecting Time Mode

Step	Action	Reference
3	Once you have reached register 138, press the Configuration key. The register value will be displayed; this is indicated by the circle icon.	
4	Use the Up/Down arrow keys to select value 1 (Time mode), then press the Configuration key to confirm the selection.	

### 7.1.2.1 Setting Time Mode Parameters

**Table 7.5** Setting Time Mode Parameters

Step	Action	Reference
1	Set the power supply to time mode.	See <a href="#">7.1.2 Selecting Time Mode</a> .
2	<p>Time mode icon and parameter value will be displayed. Use the Up/Down keys to enter the desired parameter value.</p> <p>Press the Configuration key once to confirm the selection, then press the key again to save the selection.</p> <p><b>NOTICE</b> The value on the screen will blink X3, if the configuration button is not pressed again before the selection stops blinking, the value will not be saved and must be set again.</p>	



## 7.1.3 Selecting Energy Mode

You can use Energy Mode to select the amount of ultrasonic energy that is applied to your parts. Within Energy Mode, you can also select several other parameters, ranging from afterburst to limits and cutoffs. For more information on setting the optional parameters within Energy Mode, or any other welding mode, refer to the DCX Web Page Instruction Manual.

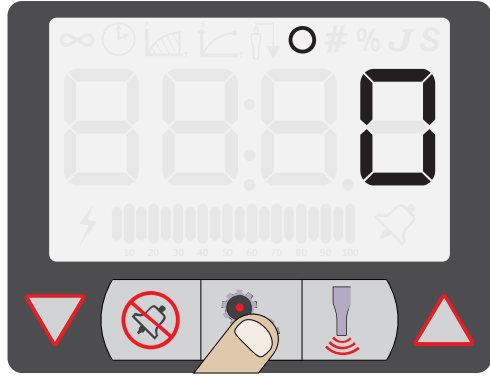

**Table 7.6** Energy Mode Parameters

Parameter	Default	Max. Value	Min. Value
Energy	1 Joules	9999 Joules	0.1 Joules

**Table 7.7** Selecting Energy Mode


Step	Action	Reference
1	<p>Press the Configuration key until the number icon (#) appears on the LCD.</p> <p>The power supply will display register 101 at every power up.</p>	 <p>The image shows a digital LCD display with the number '101' in the center. Above the number is a '#' icon. The display also shows various icons at the top and bottom, including a power button, a left arrow, a right arrow, a percentage sign, and 'JS'. Below the display are several physical buttons: a left arrow, a button with a crossed-out wrench and screwdriver, a button with a gear, a button with a lightbulb, and a right arrow. A hand is shown pressing the gear button.</p>
2	<p>Press and release the Up/Down arrow keys to select register 138. For a detailed description of available registers refer to <a href="#">Table 7.18 Power Supply Registers</a>.</p>	 <p>The image shows the same digital LCD display as in step 1, but now the number '138' is displayed in the center. The '#' icon is still present above the number. A hand is shown pressing the right arrow button.</p>

**Table 7.7** Selecting Energy Mode

Step	Action	Reference
3	Once you have reached register 138, press the Configuration key. The register value will be displayed; this is indicated by the circle icon.	
4	Use the Up/Down arrow keys to select value 2 (Energy mode), then press the Configuration key to confirm the selection.	

### 7.1.3.1 Setting Energy Mode Parameters

**Table 7.8** Setting Energy Mode Parameters

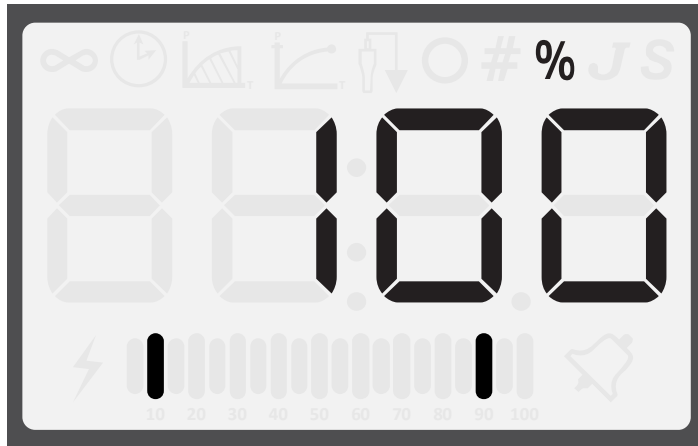
Step	Action	Reference
1	Set the power supply to energy mode.	See <a href="#">7.1.3 Selecting Energy Mode</a> .
2	<p>Energy mode icon and parameter value will be displayed. Use the Up/Down keys to enter the desired parameter value.</p> <p>Press the Configuration key once to confirm the selection, then press the key again to save the selection.</p> <p><b>NOTICE</b> The value on the screen will blink X3, if the configuration button is not pressed again before the selection stops blinking, the value will not be saved and must be set again.</p>	

## 7.2 Setting Limits

### 7.2.1 Setting Peak Power Window Limits

If peak power window limits are enabled, it will display a single slowly blinking segment for the high limit (+power) and a single slowly blinking segment for the low limit (-power) in the bar-graph. In case of a window limit alarm, the respective segment will blink faster.


**Figure 7.1** Peak Power Window Limits





### 7.2.2 +Peak Power Window Limit (PHL)

**Table 7.9** +Peak Power Window Parameters

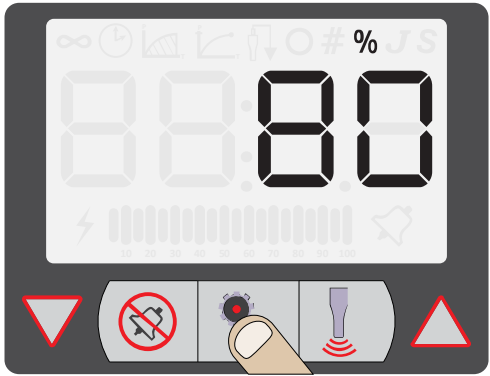
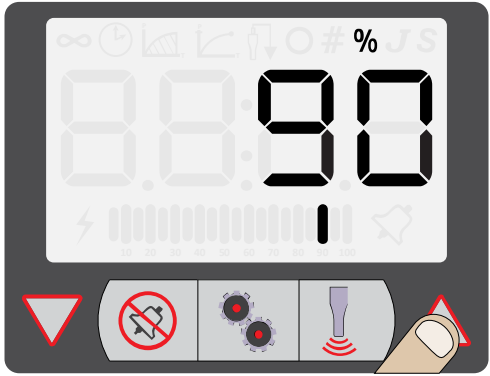
Parameter	Default	Max. Value	Min. Value
+Peak Power Window Limit	90%	100%	5%

NOTICE	
	Value must be higher than the -peak power window limit value.

NOTICE	
	Set value to 0 to set the +peak power window limit to off.




NOTICE	
	<p>Peak power window limits are set in multiples of 5.</p>

**Table 7.10** +Peak Power Window Limit Operational Sequence

Step	Action	Reference
1	<p>From the amplitude screen, press the Configuration key twice.</p>	
2	<p>The power supply will display the +peak power window limit.</p> <p>Use the Up/Down arrow keys to select the desired +peak power window limit value.</p> <p>Press the Configuration key once to confirm the selection, then press the key again to save the selection.</p> <p><b>NOTICE</b> The value on the screen will blink X3, if the configuration button is not pressed again before the selection stops blinking, the value will not be saved and must be set again.</p>	

## 7.2.2.1 Using Registers


**Table 7.11** +Peak Power Window Limit Operational Sequence - Registers


Step	Action	Reference
1	<p>Press the Configuration key until the number icon (#) appears on the LCD.</p> <p>The power supply will display register 101 at every power up.</p>	
2	<p>Press and release the Up/Down arrow keys to select register 156. For a detailed description of available registers refer to <a href="#">Table 7.18 Power Supply Registers</a>.</p>	
3	<p>Once you have reached register 156, press the Configuration key. The register value will be displayed; this is indicated by the circle icon.</p> <p>Use the Up/Down arrow keys to select the desired +peak power window limit value, then press the Configuration key to confirm the selection.</p>	


## 7.2.3 -Peak Power Window Limit (PLL)

**Table 7.12** -Peak Power Window Limit Parameters

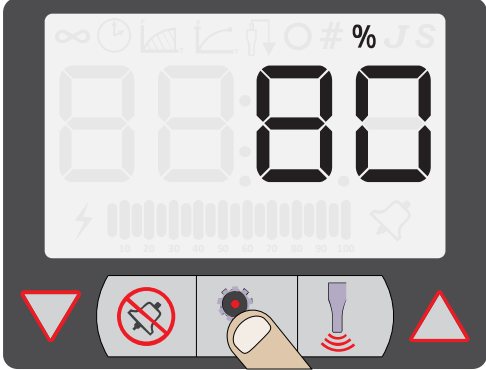

Parameter	Default	Max. Value	Min. Value
-Peak Power Window Low Limit	10%	100%	5%

NOTICE	
	Value must be lower than the +peak power window limit value.

NOTICE	
	Set value to 0 to set the -peak power window limit to off.


NOTICE	
	Peak power window limits are set in multiples of 5.

**Table 7.13** -Peak Power Window Limit Operational Sequence



Step	Action	Reference
1	From the amplitude screen, press the Configuration key once.	
2	<p>The power supply will display the -peak power window limit.</p> <p>Use the Up/Down arrow keys to select the desired -peak power window limit value.</p> <p>Press the Configuration key once to confirm the selection, then press the key again to save the selection.</p> <p><b>NOTICE</b> The value on the screen will blink X3, if the configuration button is not pressed again before the selection stops blinking, the value will not be saved and must be set again.</p>	

### 7.2.3.1 Using Registers

**Table 7.14** -Peak Power Window Limit Operational Sequence (Registers)

Step	Action	Reference
1	<p>Press the Configuration key until the number icon (#) appears on the LCD.</p> <p>The power supply will display register 101 at every power up.</p>	

**Table 7.14** -Peak Power Window Limit Operational Sequence (Registers)

Step	Action	Reference
2	<p>Press and release the Up/Down arrow keys to select register 155. For a detailed description of available registers refer to <a href="#">Table 7.18 Power Supply Registers</a>.</p>	
3	<p>Once you have reached register 155, press the Configuration key. The register value will be displayed; this is indicated by the circle icon.</p> <p>Use the Up/Down arrow keys to select the desired -peak power window limit value, then press the Configuration key to confirm the selection.</p>	


## 7.2.4 Using the Web Page Interface

Window limits can be set to a user specified value using the web page interface. For more information, refer to the DCX 222 RM SIG Rack Mount Series Web Page Interface Instruction Manual.

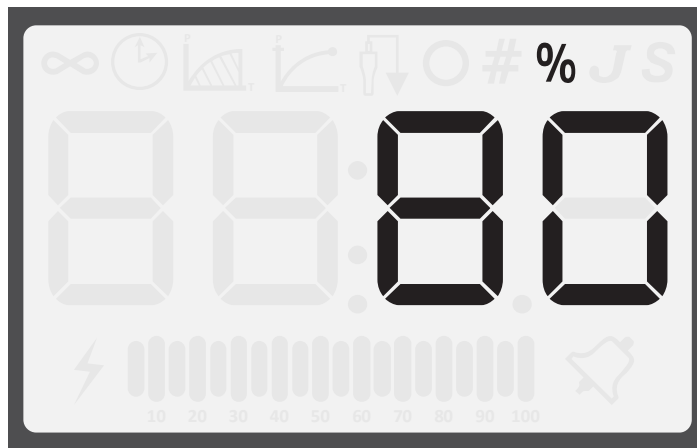
## 7.3 Setting the Amplitude

### 7.3.1 Using the Front Panel Controls

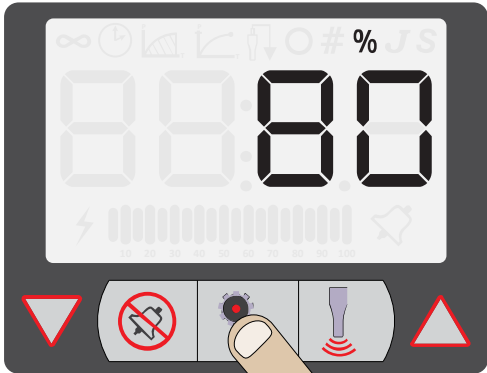
At power up the DCX 222 RM SIG Power Supply will display the last amplitude setting on the LCD. It can also be set to show weld mode.

NOTICE	
	<p>The amplitude value will be 80% only for the SIG special.</p>


**Figure 7.2** LCD at Power Up



**Table 7.15** Setting the Amplitude Using the Front Panel Controls

Step	Action	Reference
1	Press the Configuration key until the percentage icon (%) and no mode icons are displaying on the LCD.	

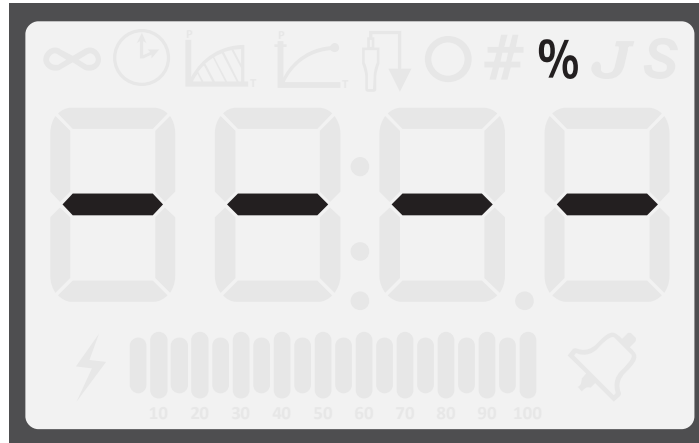
**Table 7.15** Setting the Amplitude Using the Front Panel Controls

Step	Action	Reference
2	<p>Press and release the Up or Down arrow keys to select the desired amplitude at 1% increments.</p> <p>Press and hold down the Up or Down arrow keys and the Amplitude will auto increment at 1% increments every quarter of a second.</p> <p>After holding down an arrow key for four straight seconds, the amplitude will auto increment at 5% increments every quarter of a second.</p> <p>Press the Configuration key once to confirm the selection, then press the key again to save the selection.</p> <p><b>NOTICE</b> The value on the screen will blink X3, if the configuration button is not pressed again before the selection stops blinking, the value will not be saved and must be set again.</p>	

### 7.3.2 Using External Amplitude Control

When External Amplitude Control is enabled, the front panel amplitude control is disabled and the LCD displays four dashes (see [Figure 7.3 LCD when in External Amplitude Control Mode](#) below).

**Figure 7.3** LCD when in External Amplitude Control Mode



The ultrasonic amplitude can be controlled using one of the two analog input pins on the user I/O connector (pins 17 and 18).

### 7.3.3 Using the Web Page Interface


The ultrasonic amplitude can be set to a user specified value using the web page interface. For more information, refer to the DCX Series Web Page Interface Instruction Manual.

## 7.4 Resetting the Power Supply Alarms

You need to reset the weld system when you get an overload. When there is an overload, the alarm icon appears on the front panel LCD and the General Alarm output on the user I/O connector becomes active. The procedure for resetting the power supply depends on the power supply alarm settings. Refer to [Table 7.16 Resetting the DCX 222 RM SIG Power Supply](#) for reset procedures.

**Table 7.16** Resetting the DCX 222 RM SIG Power Supply

Alarm Setting	Reset Procedure
Latching Alarms	Press the front panel Reset key. You can also send an External Reset signal.
Non-Latching Alarms	Remove and re-apply the start signal.



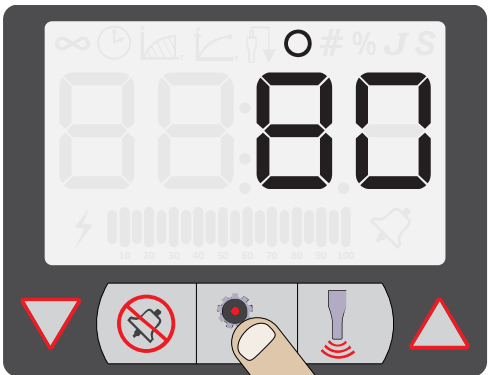
NOTICE	
	Alarm circuitry requires at least 20 ms before restarting ultrasonic power.

For more information on interfacing the DCX 222 RM SIG Power Supply using the user I/O connections refer to [5.3.4 User I/O Connections](#) in [Chapter 5: Installation and Setup](#).



## 7.5 Configuring the Power Supply Registers

At power up the DCX 222 RM SIG Power Supply will display the last amplitude setting, this is indicated by the percentage icon (%) on the LCD. Refer to [Figure 7.2 LCD at Power Up](#).

**Table 7.17** Steps to Configure the Power Supply Registers

Step	Action	Reference
1	<p>Press the Configuration key until the number icon (#) appears on the LCD.</p> <p>The power supply will display register 101 at every power up.</p>	
2	<p>Press and release the Up or Down arrow keys to select the desired register.</p> <p>For a detailed description of available registers refer to <a href="#">Table 7.18 Power Supply Registers</a>.</p>	
3	<p>Once you have reached the desired register, press the Configuration key.</p> <p>The register value will be displayed, this is indicated by the circle icon.</p>	

**Table 7.17** Steps to Configure the Power Supply Registers

Step	Action	Reference
4	<p>Press and release the Up or Down arrow keys to enter the desired value at 1 increments.</p> <p>Press and hold down the Up and Down arrow keys and the value will auto increment at 1 increments every quarter of a second.</p> <p>After holding down an arrow key for four straight seconds, the value will auto increment at 5 increments every quarter of a second.</p> <p>Or press the Reset key to enter the default value. For detailed default values of available registers refer to <a href="#">Table 7.18 Power Supply Registers</a>.</p>	 <p>The image shows a digital display with the number '150' in large digits. Above the digits are several small icons: an infinity symbol, a clock, a signal strength indicator, a left arrow, a right arrow, a circle with a dot, a hash symbol, a percent sign, and the letters 'J S'. Below the digits is a battery level indicator. At the bottom of the display are four buttons: a left-pointing triangle, a button with a crossed-out arrow, a button with a gear, and a button with a lightbulb. A finger is shown pressing the gear button.</p>
5	<p>Press the Configuration key to save the value. The current amplitude setting will be displayed only for continuous mode. For all the other modes, it will display the primary parameter of that mode.</p>	 <p>The image shows a digital display with the number '100' in large digits. Above the digits are several small icons: an infinity symbol, a clock, a signal strength indicator, a left arrow, a right arrow, a circle with a dot, a hash symbol, a percent sign, and the letters 'J S'. Below the digits is a battery level indicator. At the bottom of the display are four buttons: a left-pointing triangle, a button with a crossed-out arrow, a button with a gear, and a button with a lightbulb. A finger is shown pressing the gear button.</p>

## 7.5.1 Power Supply Registers

**Table 7.18** Power Supply Registers

Register	Description	Default Value	Max. Value	Min. Value
101	System software version	3.2	N/A	N/A
102	Bar graph identification after weld complete 0: Power 1: Frequency	0	1	0
104	External amplitude control - user analog input 0: Off 1: On	0	1	0
105	Amplitude ramp time (ms)	80	1000	10
106	Store frequency at end of weld 0: Off 1: On	1	1	0
107	Power up seek/scan 0: Off 1: Seek 2: Scan	2	2	0
108	Seek ramp time (ms)	80	1000	10
109	Timed seek (every 60 seconds) 0: Off 1: On	0	1	0
110	Seek time (ms)	500	1000	10
112	Frequency offset value	0	500	-500
	20 kHz		750	-750
	30 kHz		1000	-1000
115	40 kHz	0	2	0
	Restore defaults 0: Off 1: Just weld preset 2: System defaults		2	0
	116		IP address - 1	192
117	IP address - 2	168	255	0
118	IP address - 3	10	255	0
119	IP address - 4	100	255	0

**Table 7.18** Power Supply Registers

Register	Description	Default Value	Max. Value	Min. Value
120	Gateway for IP address 1	192	255	0
121	Gateway for IP address 2	168	255	0
122	Gateway for IP address 3	10	255	0
123	Gateway for IP address 4	1	255	0
124	Subnet mask for IP address 1	255	255	0
125	Subnet mask for IP address 2	255	255	0
126	Subnet mask for IP address 3	255	255	0
127	Subnet mask for IP address 4	0	255	0
128	DHCP settings 0: Server 1: Client 2: Static 3: Restore registers 116-128 to default	2	3	0
133	Impulse start disable 0: Pulse start enabled 1: Input must be maintained	0	1	0
134	Backlight time-out (s) 0: Always on	600	9999	0
135	Auto scroll step size	5	50	1
136	Power on display 0: Weld mode 1: Amplitude	1	1	0
137	Power high and power low limit alarm will reset after 500 ms 0: Off 1: On	1	1	0
138	Weld Mode 0: Continuous 1: Time 2: Energy	1	2	0
139	MAC address 1	*	FFFF	0
140	MAC address 2	*	FFFF	0
141	MAC address 3	*	FFFF	0

**Table 7.18** Power Supply Registers

Register	Description	Default Value	Max. Value	Min. Value
155	-Peak power window limit (PLL) 0: Off 1 to 100: Limit value (must be lower than register 156) <b>NOTICE</b> Peak power window limits are set in multiples of 5	10	100	0
156	+Peak power window limit (PHL) 0: Off 1 to 100: Limit value (must be higher than register 155) <b>NOTICE</b> Peak power window limits are set in multiples of 5	90	100	0
157	Memory clear when external reset through I/O 0: No memory clear 1: Memory clear	1	1	0

\*Value depends on each system.

## 7.6 LCD Bar-Graph

While ultrasonic power is active the LCD will always display the power value on the 20-segment LCD bar-graph as a percentage of the maximum output power.

At the end of a weld or test cycle, the bar-graph is factory set to represent the cycle's peak power as a percentage of the maximum output power.

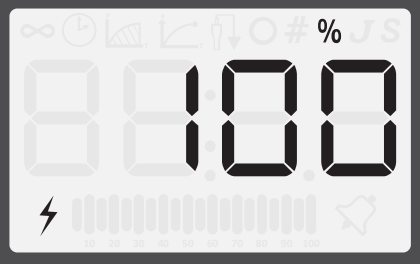
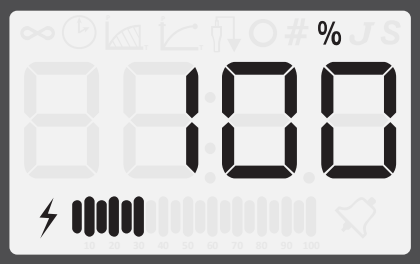
The power supply can also be configured to show a single bar on the LCD bar-graph to represent the stack operating frequency stored at the end of each weld or test cycle. This option can be used to troubleshoot operating frequency changes as a result of heating effects, coupling, tooling wear, etc.

For information on how to set the power supply registers see [7.5 Configuring the Power Supply Registers](#).

### 7.6.1 Power Bar-Graph Interpretation


The lightning bolt left of the bar-graph indicates ultrasonic power is running. Each of the segments represent 5% increments of the maximum output power. The segments will only appear if the output power has exceeded the value represented. For example if the power is 4% only the lightning bolt will be on. When it reaches 5% the first bar-graph segment will appear.

**Table 7.19** Power Bar-Graph Interpretation Examples

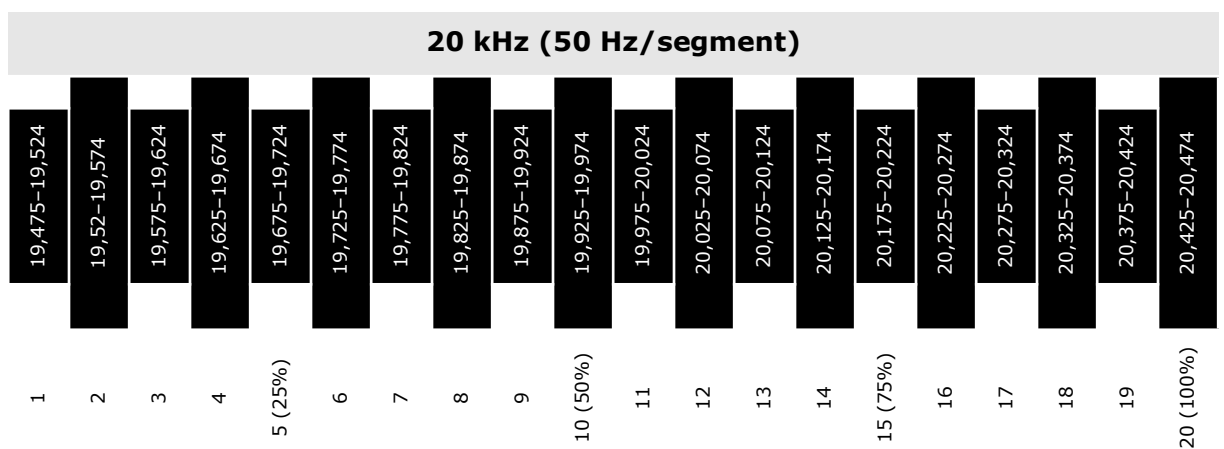
Description	Reference
<p>In this example only the lightning bolt appears left of the bar-graph. This means power is between 0% and 5%. If the power supply is 800 W the actual output power is between 0 W and 40 W.</p>	 <p>The image shows a digital LCD display with '100%' at the top right. Below the display is a 20-segment bar graph. A lightning bolt icon is lit up on the far left, and the first segment of the bar graph is also lit up. The rest of the bar graph is dimmed.</p>
<p>In this example the first six segments appear on the bar-graph. This means power is between 30% and 35%. If the power supply is 800 W, the actual output power is between 240 W and 280 W.</p>	 <p>The image shows a digital LCD display with '100%' at the top right. Below the display is a 20-segment bar graph. A lightning bolt icon is lit up on the far left, and the first six segments of the bar graph are also lit up. The rest of the bar graph is dimmed.</p>

## 7.6.2 Frequency Bar-Graph Interpretation

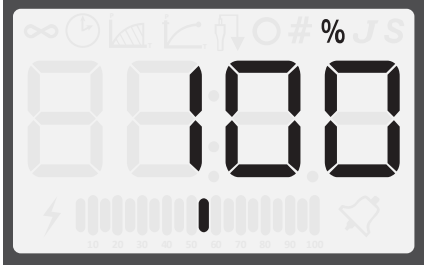
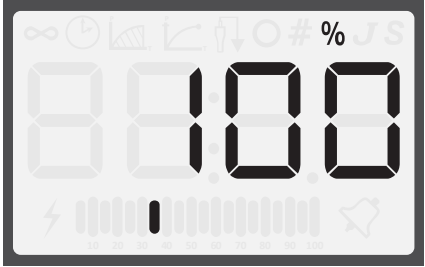
The actual frequency depends on the power supply's operating frequency. Use [Table 7.20 Frequency Bar-Graph Interpretation](#) below to interpret frequency bar-graph readings.

NOTICE	
	<p>If there is a test overload or an external memory reset signal is received, then the 50% segment will be displayed and blinking.</p>

**Table 7.20** Frequency Bar-Graph Interpretation



**Table 7.21** Frequency Bar-Graph Interpretation Examples

Description	Reference
<p>In this example the bar is located in the 11<sup>th</sup> segment. If the power supply is a 20 kHz unit, the stack is running in the frequency range of 19,975 Hz to 20,024 Hz.</p>	
<p>In this example the bar is located in the 7<sup>th</sup> segment. If the power supply is a 20 kHz unit, the stack is running in the frequency range of 19,775 Hz to 19,824 Hz,</p>	


## 7.7 Web Page Interface


The DCX 222 RM SIG Power Supply Power Supply Web Page Interface provides access, via Ethernet connection, to power supply information, diagnostics, and configuration web pages. Communication can be established point-to-point or through a local area network.

### 7.7.1 System Requirements

To connect to the DCX Web Page Interface you will need a PC running a Windows<sup>®1</sup> operating system with a Google Chrome<sup>™2</sup> or Microsoft Edge<sup>®1</sup> web browser software.

### 7.7.2 Connecting to the Web Page Interface

NOTICE	
	<p>The DCX 222 RM SIG Power Supply is not compatible with network scanning software. If your local network uses these types of programs, the DCX 222 RM SIG Power Supply IP address must be placed in an exclusion list.</p>

NOTICE	
	<p>A shielded Ethernet cable must be used to connect to the DCX 222 RM SIG Power Supply Web Page Interface to prevent possible EMI (Electromagnetic Interference) issues.</p>

#### 7.7.2.1 Point to Point Connection (Windows 10<sup>®1</sup> or Windows 11<sup>®1</sup>)

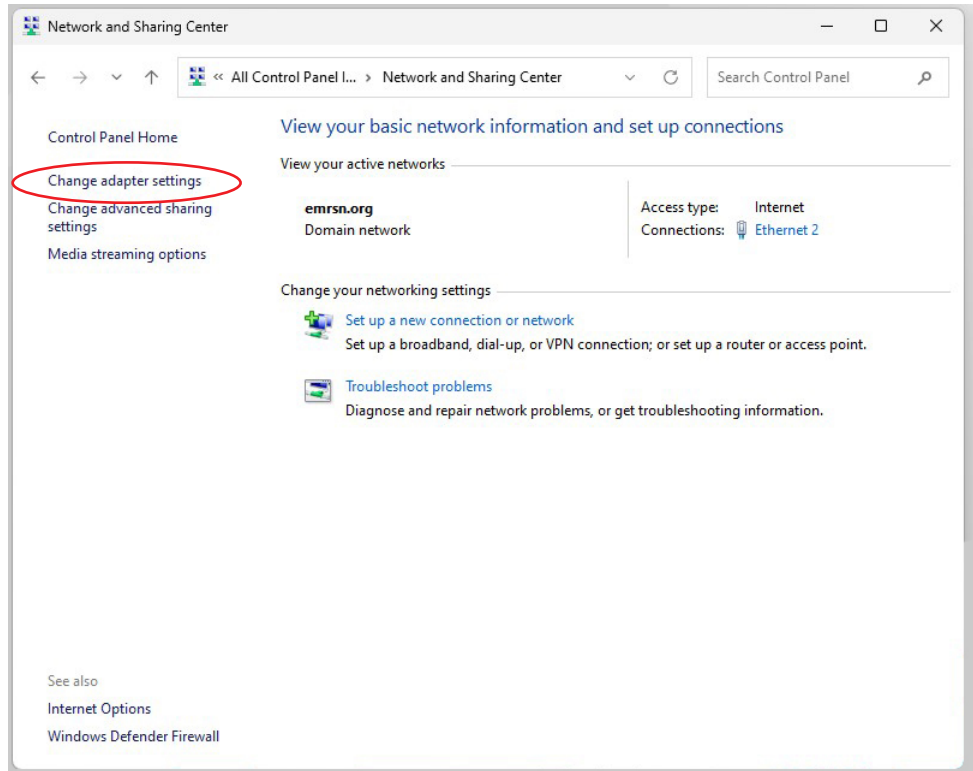
To connect directly to the DCX Power Supply Web Page Interface using a PC with Windows 10<sup>®</sup> or Windows 11<sup>®</sup> operating system, complete the following steps:

1. Connect the power supply to a computer via the Ethernet port
2. Turn on the power supply
3. On your PC, click the Start button on the taskbar and search for the **Control Panel**
4. Select **View Large Icons** on the top right corner
5. Select **Network and Sharing Center**

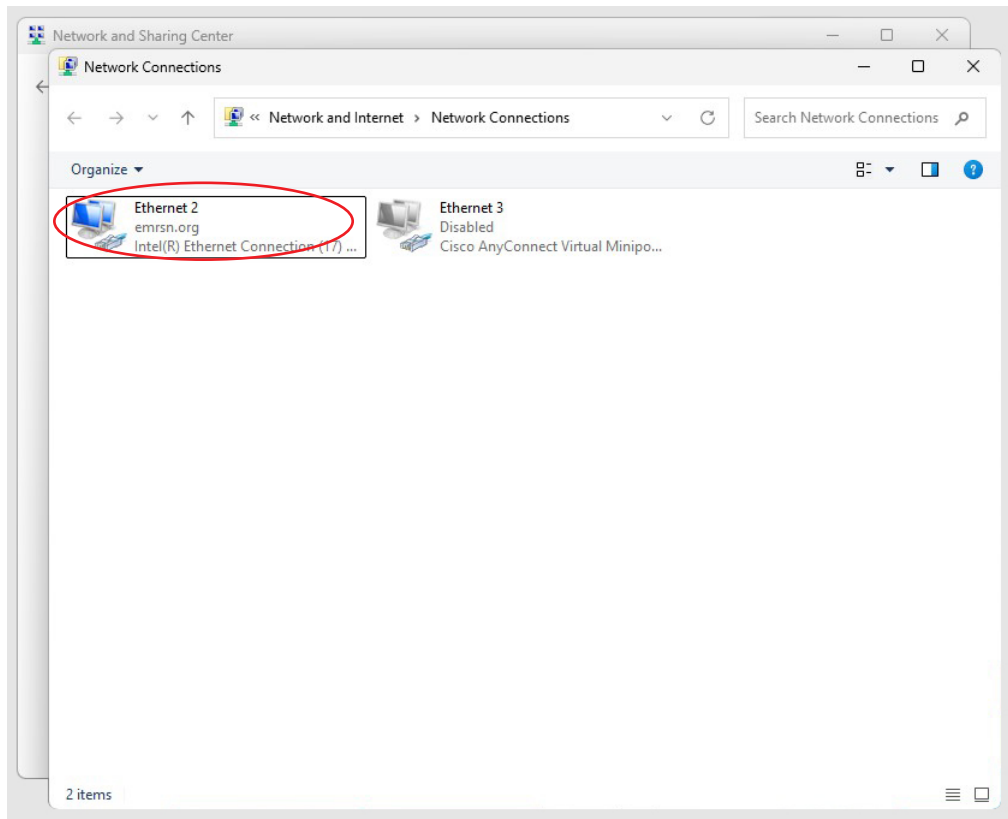
---

1. Windows 10, Windows 11, and Microsoft Edge are registered trademarks of Microsoft Corporation.  
 2. Google Chrome is a trademark of Google LLC.

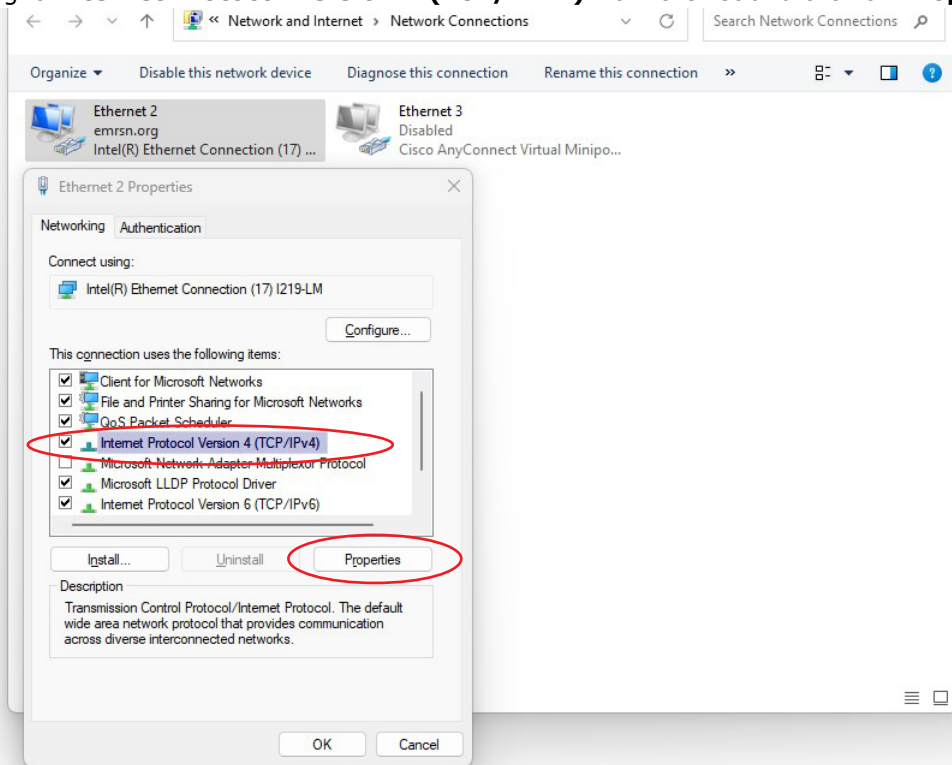
6. Select **Change adapter settings**



7. Right click on **Ethernet 2** and select **Properties** to bring up the **Networking** tab



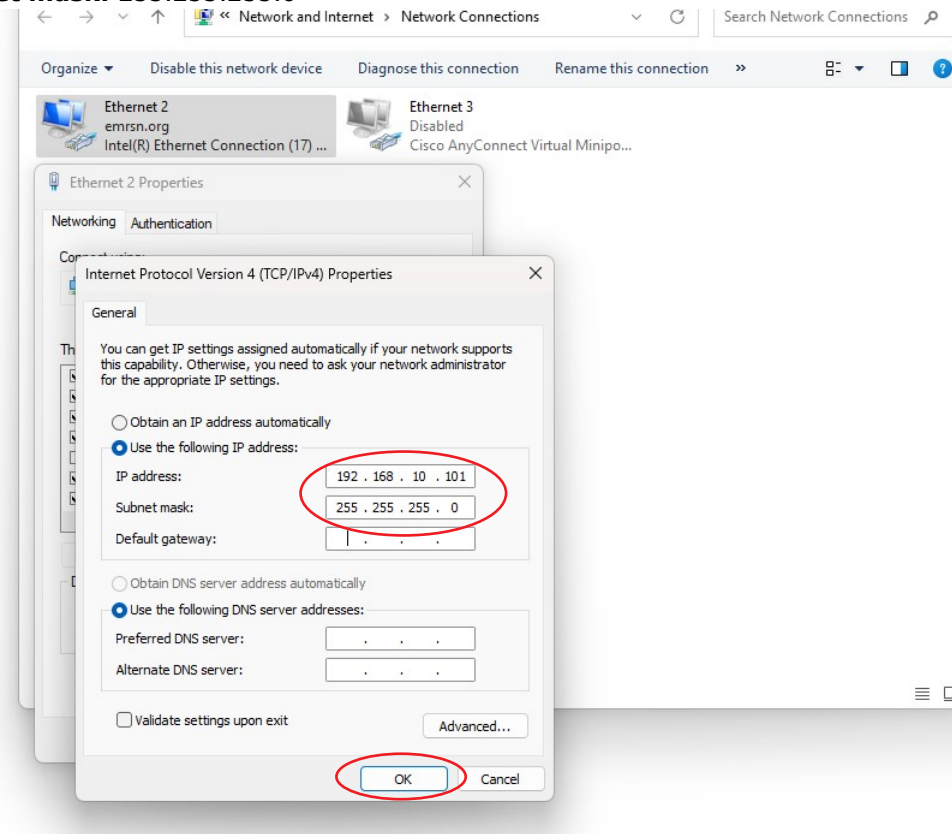
8. Highlight **Internet Protocol Version 4 (TCP/IPv4)** from the list and click on **Properties**



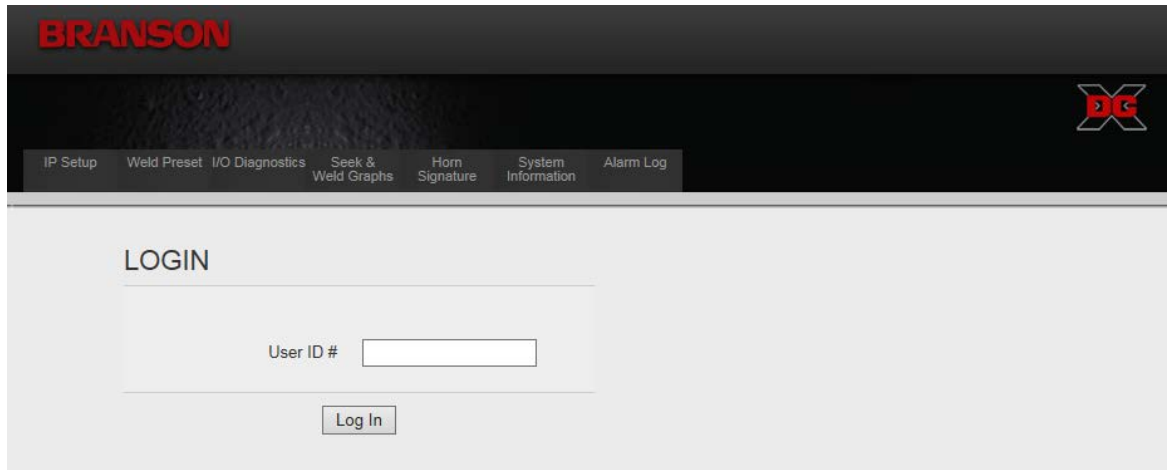
9. Use the following IP address:

**IP address:** 192.168.10.101

**Subnet mask:** 255.255.255.0



10. Click **OK**. Close the rest of the dialog boxes
11. Open the Google Chrome™ or Microsoft Edge® web browser
12. In the address bar type the following address: <http://192.168.10.100>. Press Enter
13. This will bring up the DCX 222 RM SIG Power Supply Web Page interface
14. Enter a user ID number (any number up to 9 digits long)





### 7.7.3 Using the Web Page Interface

For complete instructions detailing the web page interface consult the DCX Series Web Page Interface Instruction Manual.


## 7.8 Ultrasonics Test Procedure

The Ultrasonics Test function measures ultrasonic power dissipated by the ultrasonic stack with no load. The ultrasonics test procedure involves an automatic matching of the frequency of the power supply to the frequency of the converter-booster-horn stack.

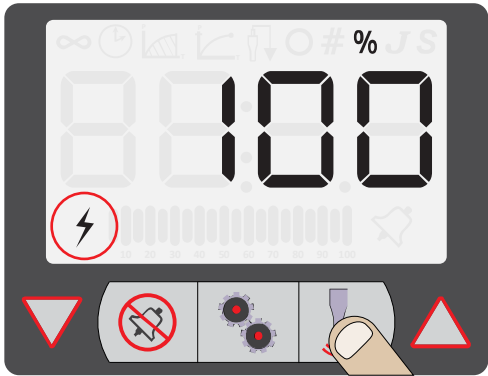
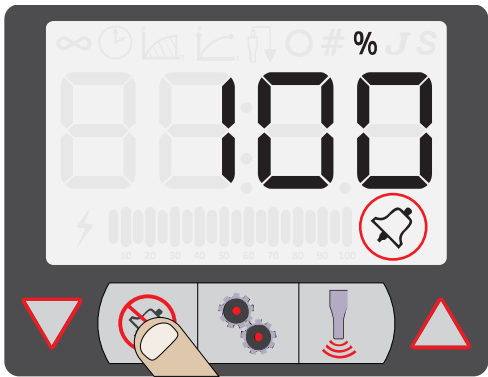
WARNING	High Voltage Hazard
	<p>Ensure that no one is in contact with the horn when testing the power supply.</p> <p>Do not cycle the welding system if either the RF cable or converter is disconnected.</p>

WARNING	High Voltage Hazard
	<p>Ensure the power supply is properly connected, as indicated in <a href="#">5.3 Installation Steps</a>.</p>

## 7.8.1 Using the Front Panel Controls



NOTICE	
	<p>To use the front panel controls, the DCX 222 RM SIG Power Supply unit must be in manual mode.</p>

**Table 7.22** Power Supply Ultrasonic Test Procedure (Front Panel)

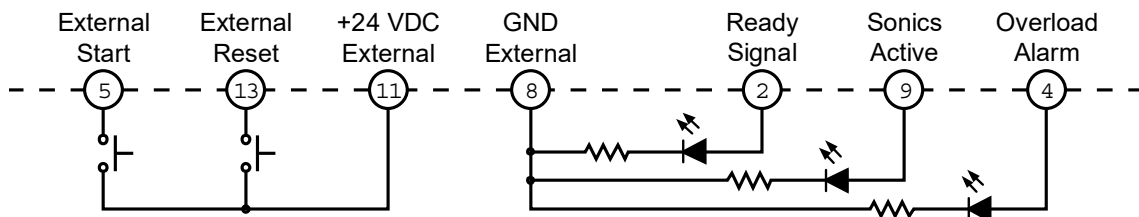
Step	Action	Reference
15	<p>Press the test key for 1-2 seconds, then release. The Sonics Active indicator appears while the test key is pressed. If the power supply alarm indicator does not appear, the test procedure is finished.</p>	
16	<p>If the alarm indicator appears, press the alarm reset key and repeat step 2 one time only. If the alarm persists, refer to <a href="#">8.5 Troubleshooting</a>.</p>	

## 7.8.2 Using the I/O Connections

**Table 7.23** Power Supply Ultrasonic Test Procedure (User I/O)

Step	Action	Reference
1	Wire the necessary I/O signals as shown on <a href="#">Figure 7.4 Test Connections</a> , or using a similar setup.	Refer to <a href="#">Figure 7.4 Test Connections</a> below.
2	Send an External Test signal for 1-2 seconds. The Sonics Active output will become active and the Sonics Active indicator appears while the External Start Signal is present. If the General Alarm output/ alarm indicator does not become active, the test procedure is finished.	
3	If the General Alarm output/alarm indicator becomes active, send an External Reset signal and repeat step 2 one time only. If the alarm persists, refer to <a href="#">8.5 Troubleshooting</a> .	

**Figure 7.4** Test Connections








---


## **Chapter 8: Maintenance**


---

<b>8.1</b>	<b>General Maintenance Considerations . . . . .</b>	<b>102</b>
<b>8.2</b>	<b>Preventive Maintenance . . . . .</b>	<b>104</b>
<b>8.3</b>	<b>Calibration. . . . .</b>	<b>108</b>
<b>8.4</b>	<b>Recommended Spare Stock . . . . .</b>	<b>109</b>
<b>8.5</b>	<b>Troubleshooting . . . . .</b>	<b>110</b>

## 8.1 General Maintenance Considerations

<b>WARNING</b>	<b>High Voltage Hazard</b>
	<p>Power supplies produce high voltage. To avoid the possibility of an electrical shock, you must always power down your system prior to repairing any portion of it.</p>
<b>CAUTION</b>	<b>General Warning</b>
	<p>When performing maintenance on the welder, make sure that no other automated systems are active.</p>
<b>NOTICE</b>	
	<p>There are no customer replaceable components inside the power supply. Have all servicing done by a qualified Branson technician.</p>
<b>NOTICE</b>	
	<p>When returning printed circuit boards, make sure to enclose them in an anti-static package.</p>
<b>NOTICE</b>	
	<p>Connectors may not be keyed and wires may not be color-coded. Therefore, when disconnecting cables and wires, label them so you can reconnect them properly.</p>


NOTICE	
	To prevent circuit damage from electrostatic discharge, always service the power supply on a static-dissipative surface, while wearing a properly grounded wrist strap.

NOTICE	
	When the battery is worn out, dispose it under the ordinance of each local government.

## 8.2 Preventive Maintenance

The following preventive measures help assure long term operation of your Branson DCX 222 RM SIG Power Supply equipment.

### 8.2.1 Periodically Clean the Equipment

NOTICE	
	Use only anti-static vacuum cleaners to prevent damage from electrostatic discharge to your power supply.


Air is continuously drawn into the power supply. Periodically disconnect the unit from power, remove the cover and vacuum out any accumulated dust and debris. Remove material adhering to:

- Power supply heat sink cooling fins
- Transformers
- Circuit boards
- Cooling intake vents
- Exhaust ports

External covers may be cleaned with a damp sponge or cloth using a solution of mild soap and water. Do not allow cleaning solution to enter the unit.

To prevent rust in areas of high humidity, exposed steel surfaces, may require a very light film of rust preventing oil, such as WD-40<sup>®</sup>.

## 8.2.2 Recondition the Stack (Converter, Booster, and Horn)

NOTICE	
	<p>Never clean the converter-booster-horn stack mating surfaces by using a buffing wheel or by filing.</p>

Welding system components work most efficiently when the converter-booster-horn stack mating surfaces are flat, in solid contact, and free from fretting corrosion. Poor contact between mating surfaces wastes power output, makes tuning difficult, increases noise and heat, and may cause damage to the converter.

For standard 20 kHz, a Branson Mylar® polyester film washer must be installed between the horn and booster, and horn and converter. Replace the washer if torn or perforated. Stacks using Mylar® plastic film washers must be inspected every three months.

Stacks used with silicone grease, as with certain 20 kHz products, must be periodically reconditioned to eliminate fretting corrosion. A stack using silicone grease must be inspected every two weeks for corrosion. When experience is gained for specific stacks, the inspection interval can be adjusted to a longer or shorter period as required.

### Stack Reconditioning Procedure

To recondition stack mating surfaces, take the following steps:

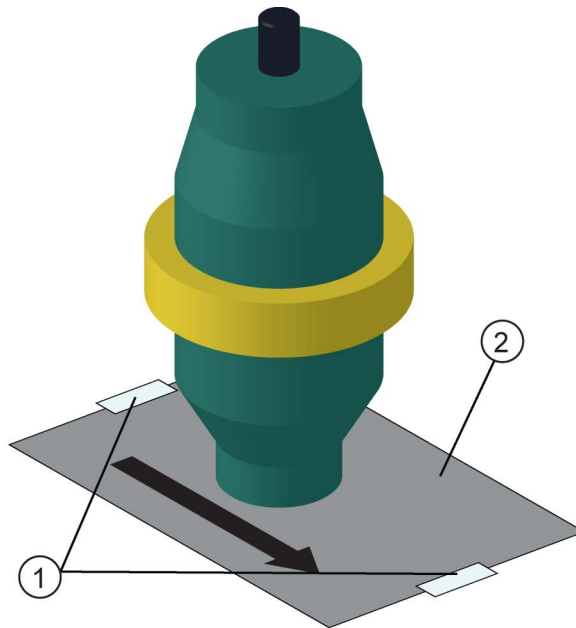
**Table 8.1** Stack Reconditioning Procedure

Step	Action
1	Disassemble the converter-booster-horn stack and wipe the mating surfaces with a clean cloth or paper towel.
2	Examine all mating surfaces. If any mating surface shows corrosion or a hard, dark deposit, recondition it.
3	If necessary, remove the threaded stud from the part.
4	Tape a clean sheet of #400 (or finer) grit emery cloth to a clean, smooth, flat surface (such as a sheet of plate glass), as in <a href="#">Figure 8.1 Reconditioning Stack Mating Surfaces</a> .
5	Place the interface surface on the emery cloth. Grasp the part at the lower end, with your thumb over the spanner-wrench hole, and lap the part in a straight line across the emery cloth. Do not apply downward pressure — the weight of the part alone provides sufficient pressure.
6	Lap the part, two or three times, in the same direction against the emery cloth. (See <a href="#">Figure 8.1 Reconditioning Stack Mating Surfaces</a> ).
7	Rotate the part 120 degrees, placing your thumb over the spanner-wrench hole, and repeat the lapping procedure in step 6.

**Table 8.1** Stack Reconditioning Procedure

Step	Action
8	Rotate the part another 120 degrees to the next spanner-wrench hole, and repeat the lapping procedure in step 6.
9	Re-examine the mating surface. If necessary, repeat steps 2-5 until you remove most of the contaminant. Remember, this should not require more than two to three complete rotations for an aluminum horn or booster; a titanium component may require more rotations.
10	<p>Before re-inserting a threaded stud in an aluminum booster or horn: Using a file card or wire brush, clean any aluminum bits from the knurled end of the stud.</p> <p>Using a clean cloth or towel, clean the threaded hole.</p> <p>Examine the knurled end of the stud. If worn, replace the stud. Also, examine the stud and threaded hole for stripped threads.</p> <p><b>NOTICE</b> Threaded studs cannot be reused in titanium horns or boosters. Replace all studs in these components.</p>
11	Assemble and install the stack.

**Figure 8.1** Reconditioning Stack Mating Surfaces



**Table 8.2** Reconditioning Stack Mating Surfaces

Item	Description
1	Tape
2	#400 Emery Cloth

### 8.2.2.1 Stack Reassembly Process

**Table 8.3** Stack Torque Value

Frequency	Torque
20 kHz	Converter–Booster: 50 N·m Booster–Horn: 75 N·m

### For a 20 kHz System

**Table 8.4** Stack Reassembly for a 20 kHz System

Step	Action
1	Clean the mating surfaces of the converter, booster, and horn. Remove any foreign material from the threaded holes.
2	Install the threaded stud into the top of the booster. Torque to 50 N·m. If the stud is dry, apply 1 or 2 drops of a light lubricating oil before installing.
3	Install the threaded stud into the top of the horn. Torque to 50 N·m. If the stud is dry, apply 1 or 2 drops of a light lubricating oil before installing.
4	Install a single Mylar <sup>®</sup> plastic film washer (matching the size of the washer to the stud) to each interface.
5	Assemble the converter to the booster and the booster to the horn.
6	Torque to 50 N·m for the converter–booster and 75 N·m for the booster–horn.

### 8.2.3 Stud Torque Values

**Table 8.5** Stud Torque Values

Used on	Stud Size	Torque	EDP #
20 kHz	1/2 in x 20 x 1-1/4 in	50 N·m	100-098-370
	1/2 in x 20 x 1-1/2 in		100-098-123

### 8.2.4 Routine Component Replacement

The lifetime of certain parts is based on the number of cycles the unit has completed, or on hours of operation.

## 8.3 Calibration

This product does not normally require scheduled calibration. However, if you are operating under any type of regulatory requirements, you may need to calibrate the equipment according to that schedule and set of standards. Contact Branson for details.

## 8.4 Recommended Spare Stock

This section provides lists of replacement parts, system cables, and suggested spares.

### 8.4.1 Converters Compatible with the DCX 222 RM SIG Power Supply

**Table 8.6** Converters Compatible with the DCX 222 RM SIG Power Supply

Where used	Model	Connector	Part Number
20 kHz	932 AS	MHV Connector	159-135-077

### 8.4.2 DCX 222 RM SIG Power Supply Compatible Boosters

**Table 8.7** DCX 222 RM SIG Power Supply Compatible Boosters

Type of Booster	Description	Part Number
Standard Series (1/2-20 horn stud) 20 kHz	Titanium, 1:1 (Green)	101-149-056
	Titanium, 1:1.5 (Gold)	101-149-057

### 8.4.3 Other Items used with the DCX 222 RM SIG Power Supply

**Table 8.8** Other Items used with the DCX 222 RM SIG Power Supply


Description	Part Number
Silicone Grease	101-053-002

## 8.5 Troubleshooting


If you have a problem operating the DCX 222 RM SIG Power Supply, take the following steps:

**Table 8.9** Troubleshooting

Step	Action
1	Make sure the converter-booster-horn stack is properly assembled and installed.
2	For instructions on reconditioning stack component surfaces, refer to <a href="#">8.2.2 Recondition the Stack (Converter, Booster, and Horn)</a> .
3	If you need additional help, call your local Branson representative, refer to <a href="#">1.3 How to Contact Branson</a> .

NOTICE	
	DCX 222 RM SIG Power Supply must be serviced only by qualified technicians using Branson-approved test and repair equipment, repair procedures, and replacement parts. Unauthorized attempts at repair or modification of the power supply will void the warranty.

### 8.5.1 Common Electrical Problems

NOTICE	
	If the circuit breaker fails more than once, this usually indicates that another component has failed. Continue troubleshooting other components.

**Table 8.10** Troubleshooting Common Electrical Problems

Problem	Check	Solution
When touching a component of the weld system, you get a slight electrical shock.	Ensure the ground cable is connected properly.	N/A
	Inspect the line cables	If failed, repair or replace.

## 8.5.2 Ultrasonic Power Problems

**Table 8.11** Troubleshooting Ultrasonic Power Problems

Problem	Check	Solution
Ultrasonic power delivered to horn; no indication on bar graph.	Check connector cables, replace if failed.	Replace defective cables.
	Test power supply.	See <a href="#">Chapter 7: Operation 7.8 Ultrasonics Test Procedure</a>
No ultrasonic power generated when Test key pressed; no Alarm indicator.	Failed or missing stack.	Replace.
	RF cable unplugged or failed; replace if failed.	Plug in or replace.
	Test power supply ( <a href="#">Chapter 7: Operation 7.8 Ultrasonics Test Procedure</a> ).	If defective, send unit for repair.
Unable to adjust amplitude using the front panel keypad.	Register setting configured to "External Amplitude Control"	Reset if required. See <a href="#">Chapter 7: Operation 7.5 Configuring the Power Supply Registers</a> .
Unable to remote control.	User I/O cable	Repair or replace.
	Customer's switching device	Test/inspect/repair/replace.

## 8.5.3 Weld Cycle Problems

**Table 8.12** Troubleshooting Weld Cycle Problems

Problem	Check	Solution
Full ultrasonic power not delivered.	Unsuitable horn or booster selection.	Contact Branson.
	Plastic part material varies.	
	Mold release lubricant in weld area.	
	Unsuitable joint design.	
	Unsuitable or misaligned part fixture.	
	Amplitude setting.	Adjust if required.
No ultrasonic power passed to horn.	Power supply overheating.	Remove dust and debris.
Alarm indicator illuminates when you press the Test key or during the weld cycle.	Check converter-booster-horn stack interface for fretting corrosion.	See <a href="#">8.2.2 Recondition the Stack (Converter, Booster, and Horn)</a>
	Check for loose or failed horn converter or booster.	Tighten or replace as needed.
	Check for loose or failed horn or booster stud.	
	Failed RF cable.	Replace if failed.
Excessively warm horn, booster, and converter; occasional overloads.	Check converter-booster-horn stack mating surfaces for fretting corrosion.	See <a href="#">8.2.2 Recondition the Stack (Converter, Booster, and Horn)</a> .
	Be certain proper cooling has been provided.	See <a href="#">5.2.1 Installing the DCX 222 RM SIG Power Supply Drawers in a Customer Rack.</a>

---

# **Appendix A: Signal Diagrams**

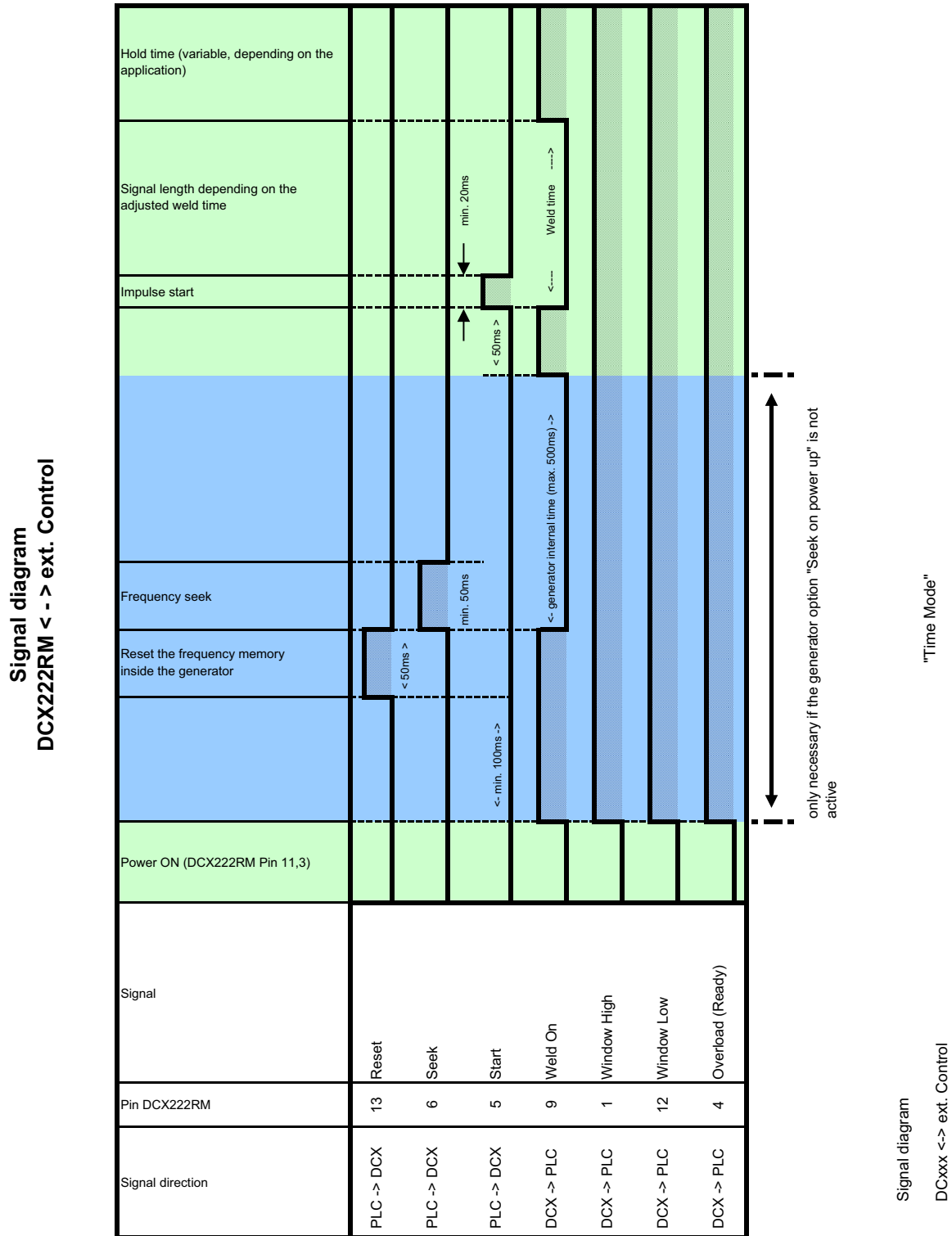
---

**A.1 Signal Diagrams .....114**

## A.1 Signal Diagrams

### A.1.1 Time Mode

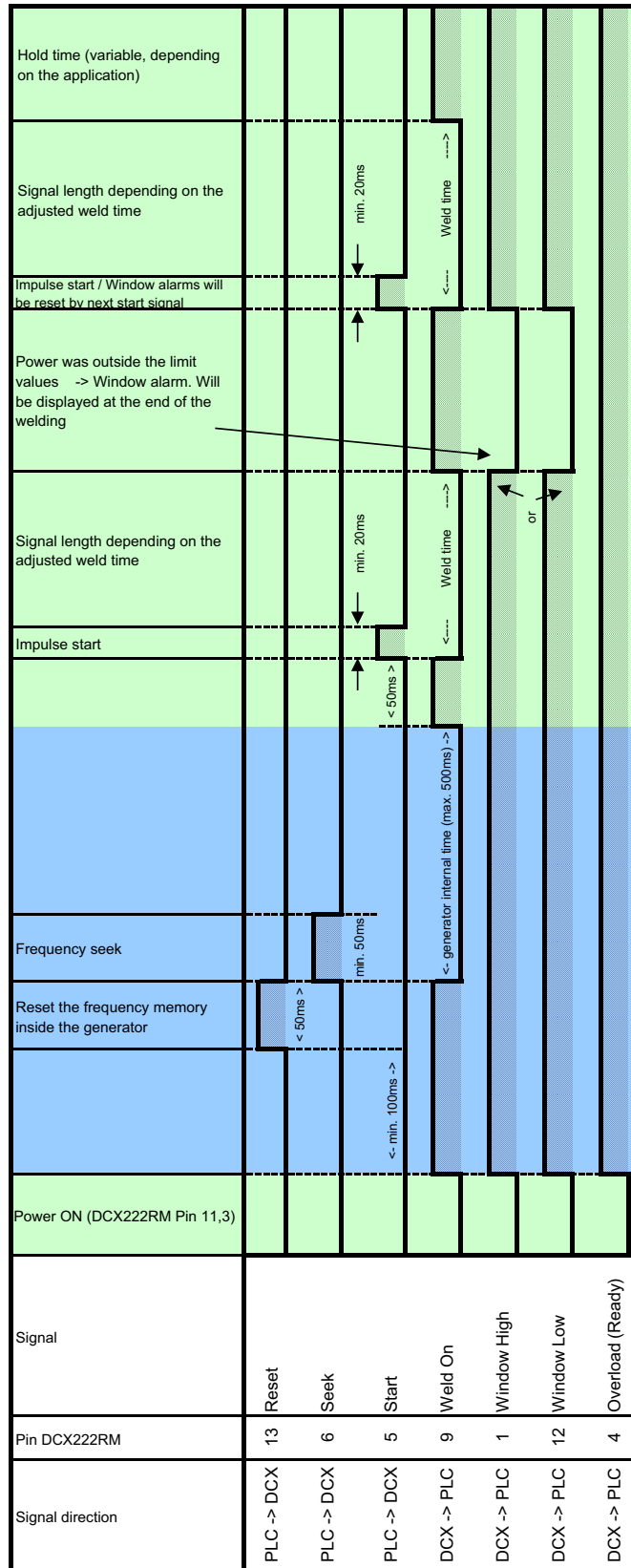
Figure A.1 Time



## A.1.2 Time Mode (Window Alarm)

Figure A.2 Time Mode (Window Alarm)

Signal diagram  
DCX222RM <- -> ext. Control



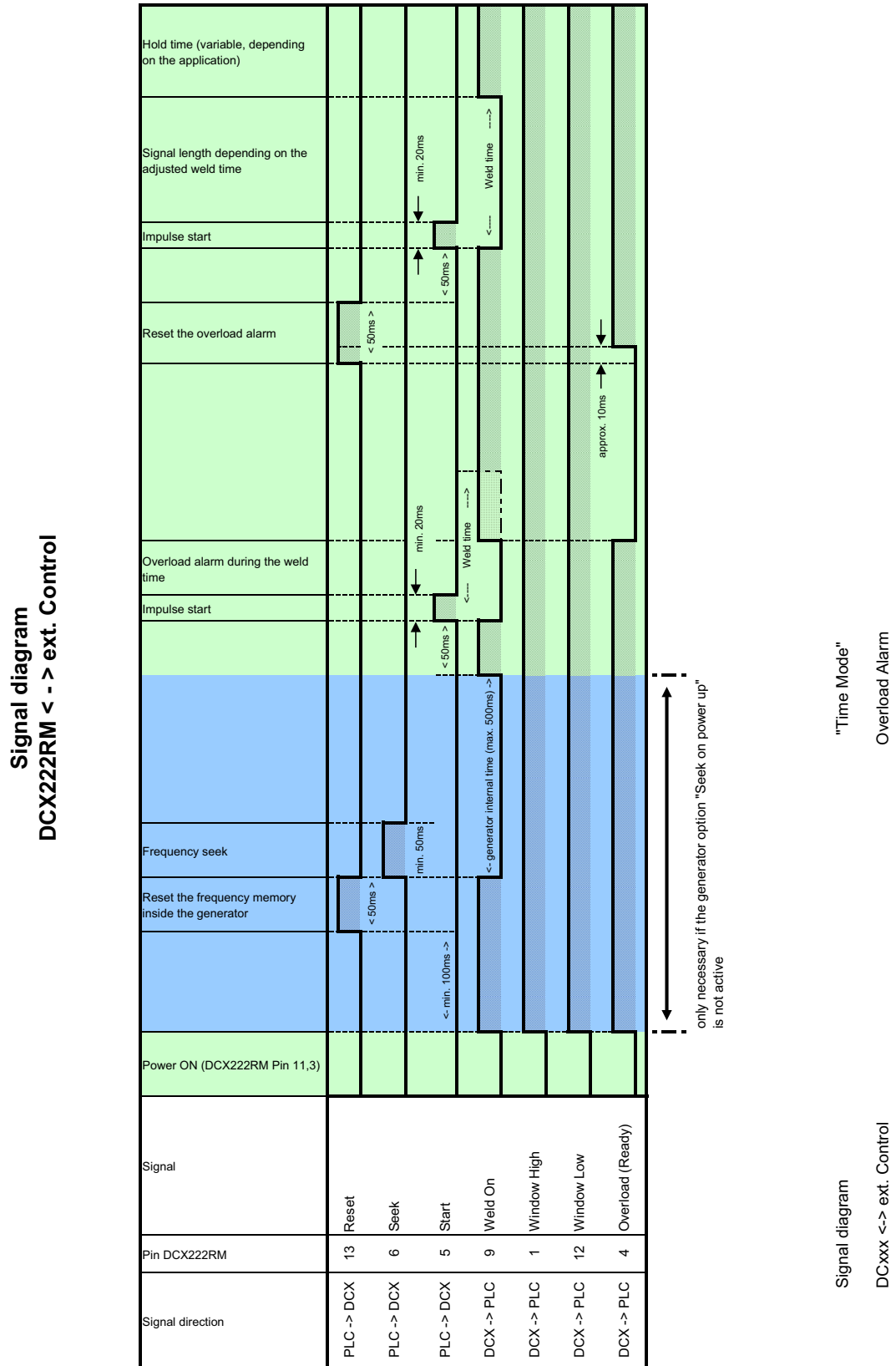
only necessary if the generator option "Seek on power up" is not active

Signal diagram  
DCxxx <-> ext. Control

"Time Mode"  
Window Alarm

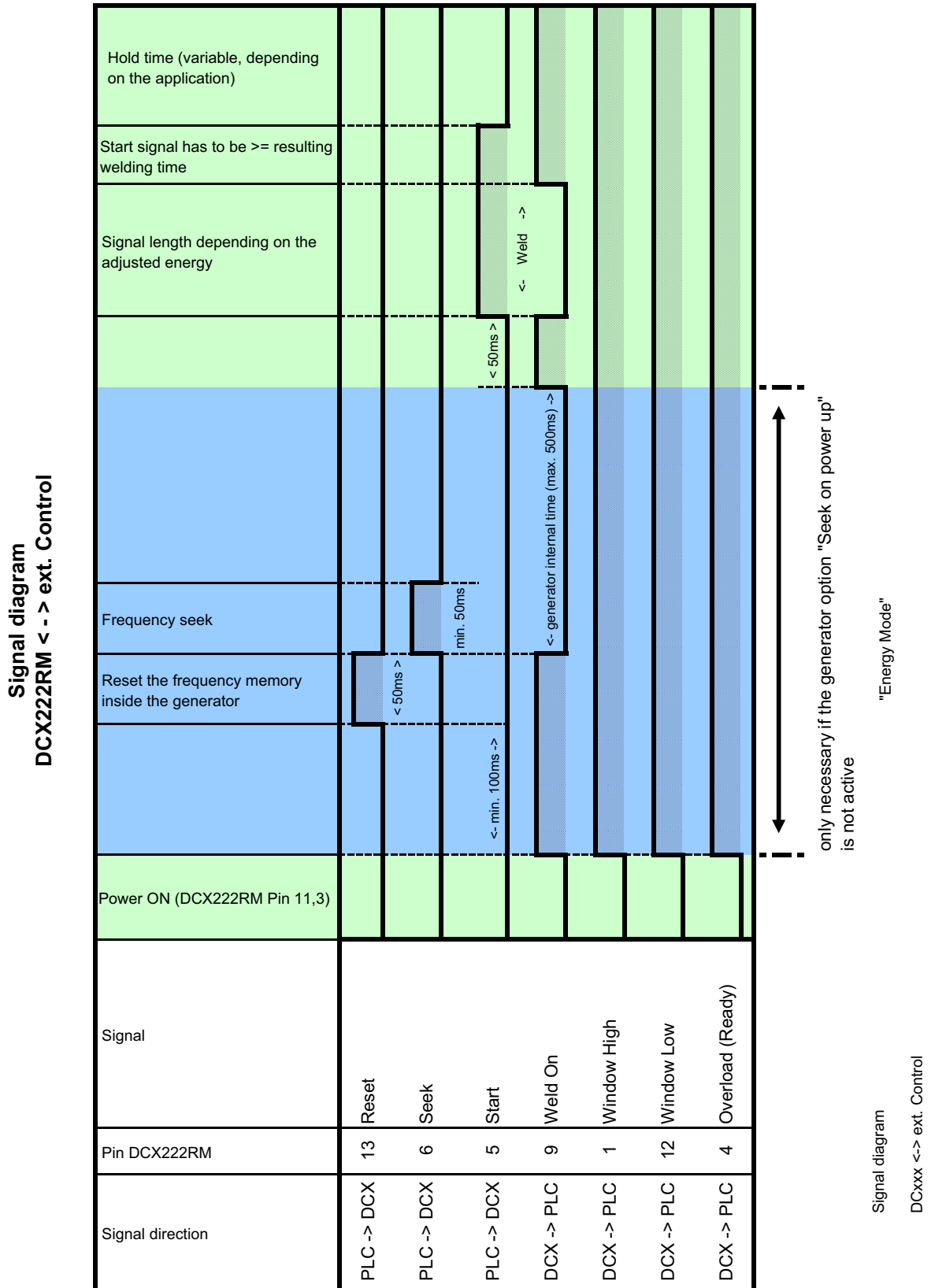
## A.1.3 Time Mode (Overload Alarm)

Figure A.3 Time Mode (Overload Alarm)



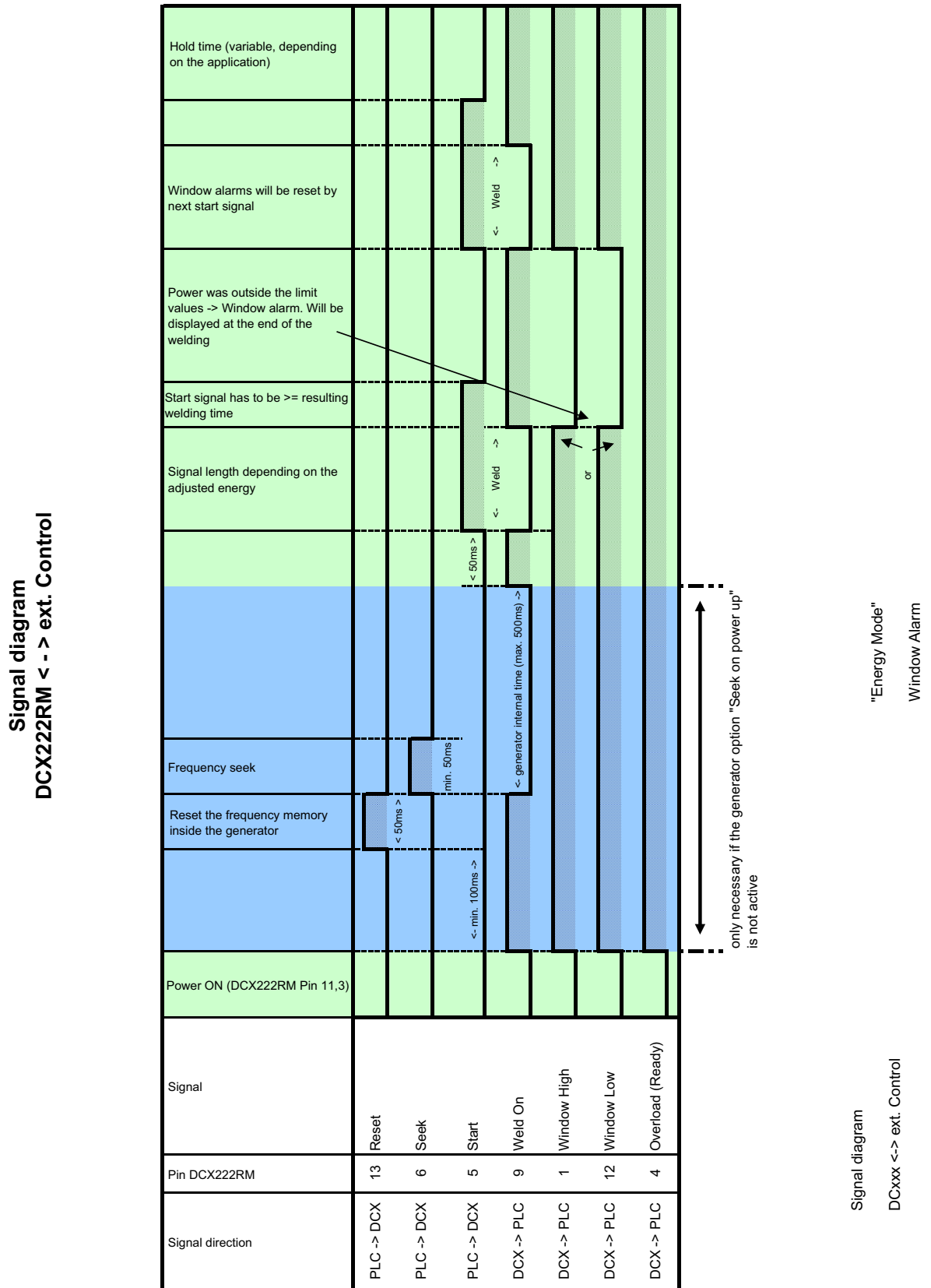
## A.1.4 Energy Mode

Figure A.4 Energy Mode



## A.1.5 Energy Mode (Window Alarm)

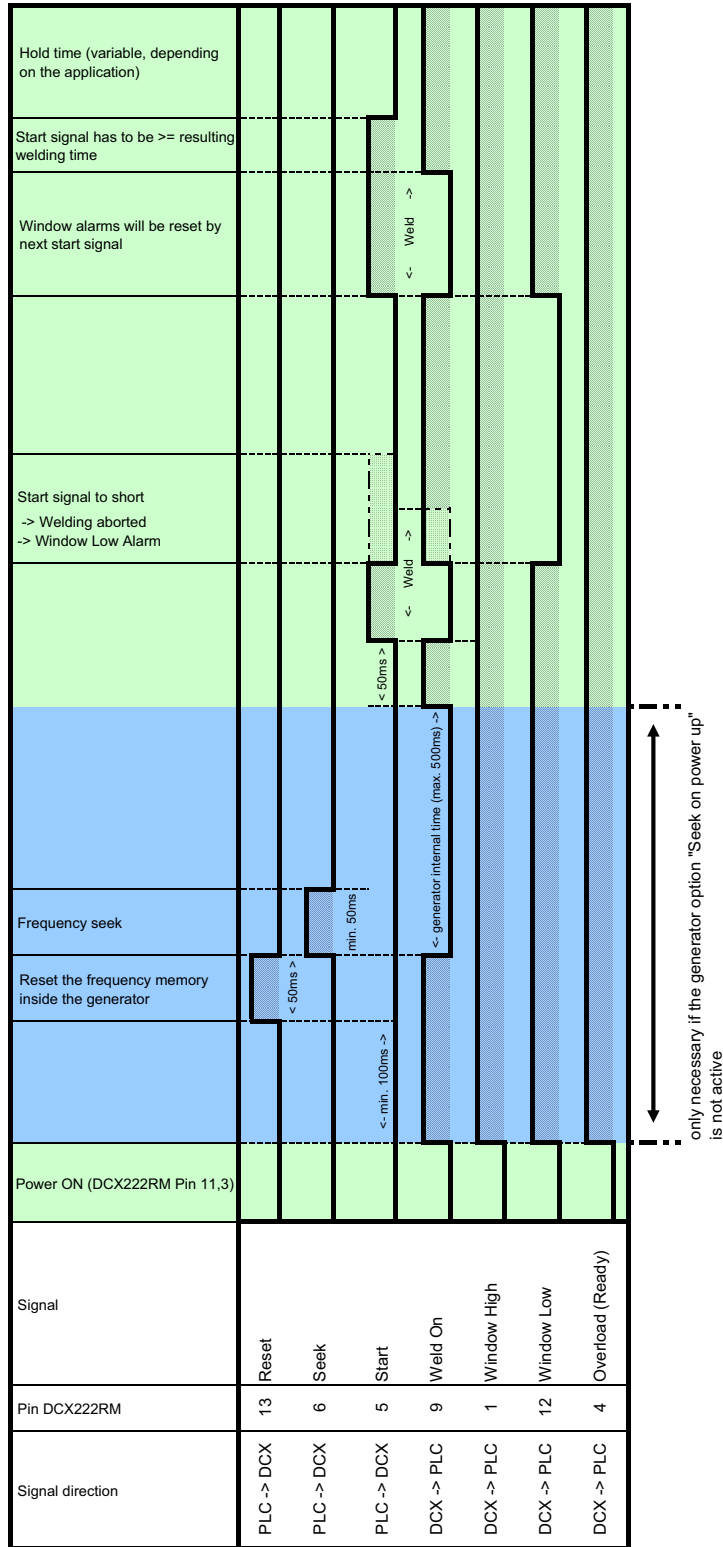
Figure A.5 Energy Mode (Window Alarm)



## A.1.6 Energy Mode (Start Signal Too Short)

Figure A.6 Energy Mode (Window Low Alarm - Start Signal Too Short)

Signal diagram  
DCX222RM < - > ext. Control

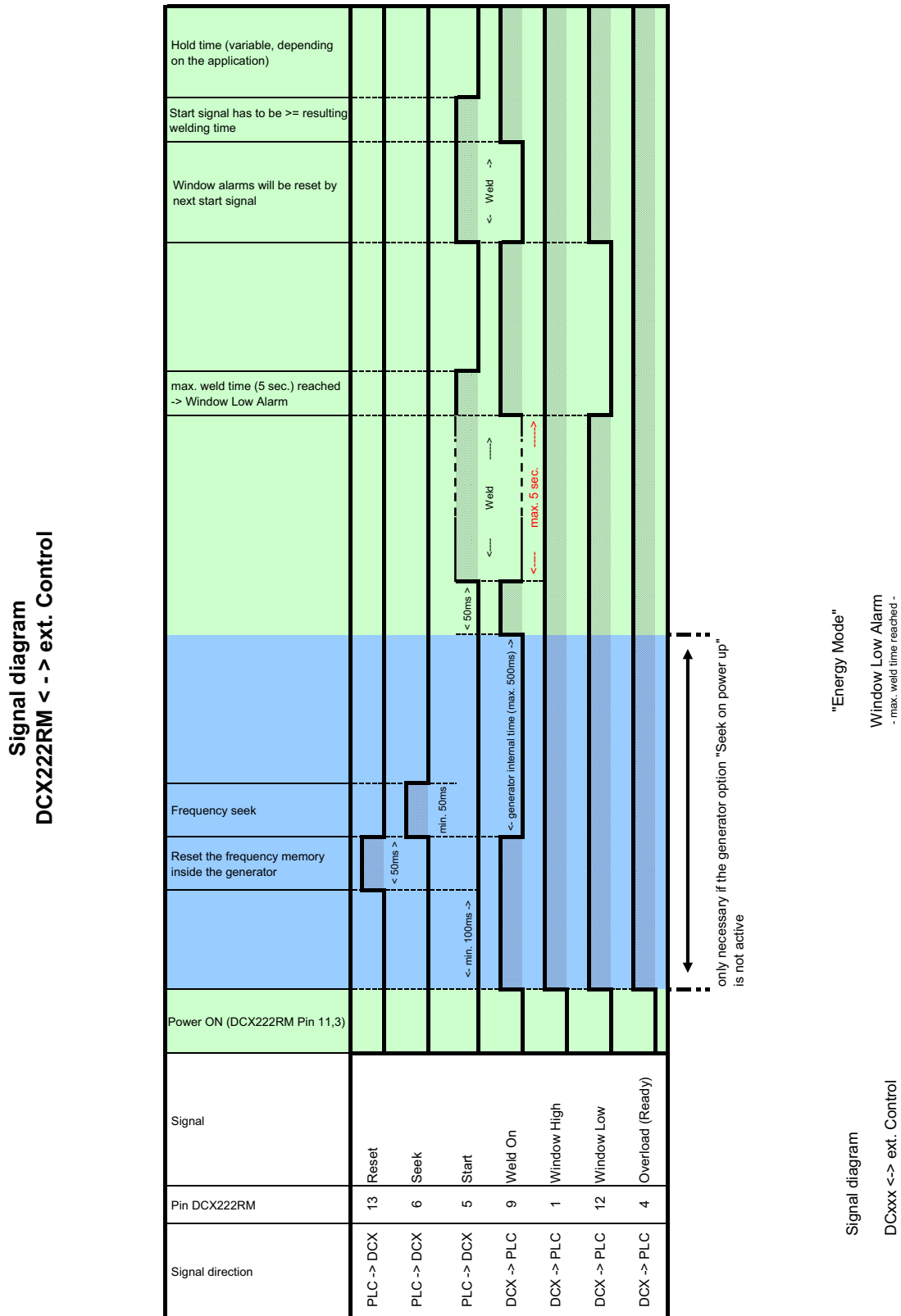


"Energy Mode"  
Window Low Alarm  
- Start signal too short -

Signal diagram  
DCxxx <-> ext. Control

## A.1.7 Energy Mode (Max. Weld Time Reached)

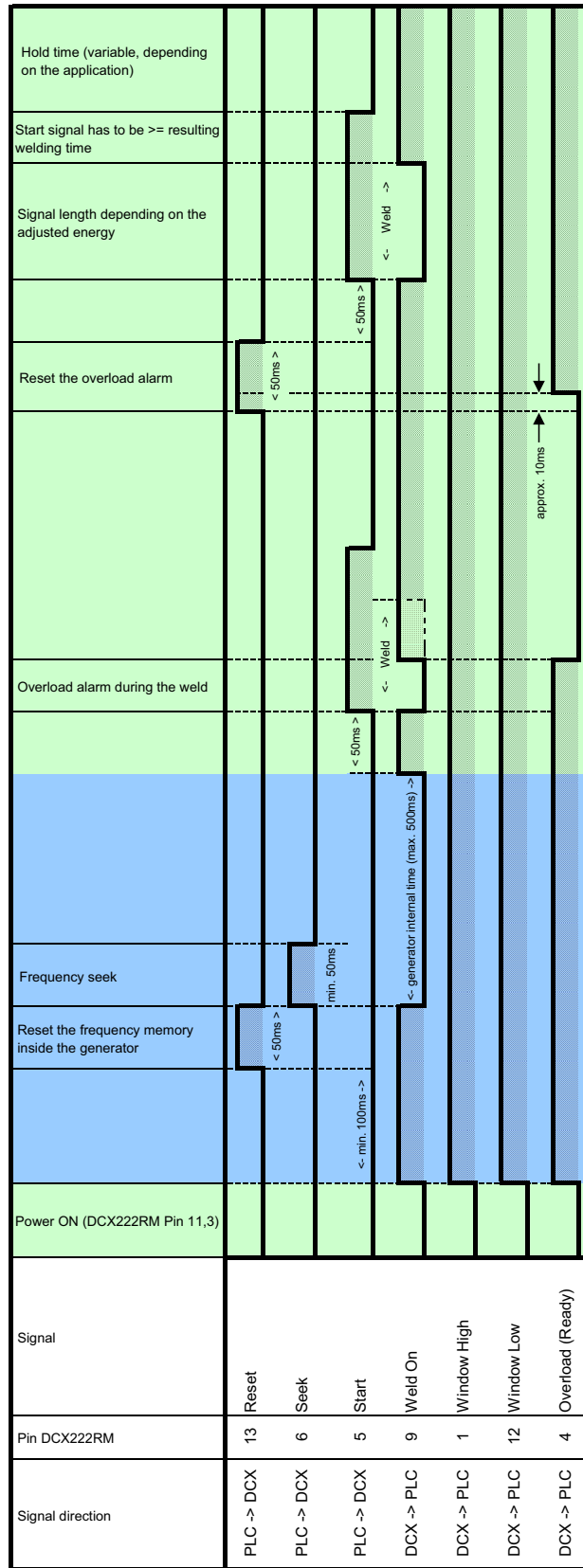
Figure A.7 Energy Mode (Window Low Alarm - Max. Weld Time Reached)



## A.1.8 Energy Mode (Overload Alarm)

Figure A.8 Energy Mode (Overload Alarm)

Signal diagram  
DCX222RM <-> ext. Control



only necessary if the generator option "Seek on power up" is not active

"Energy Mode"  
Overload Alarm

Signal diagram  
DCxxx <-> ext. Control



---

## **Appendix B: Manual's Revisions**

---

**B.1 Manual's Revisions .....124**

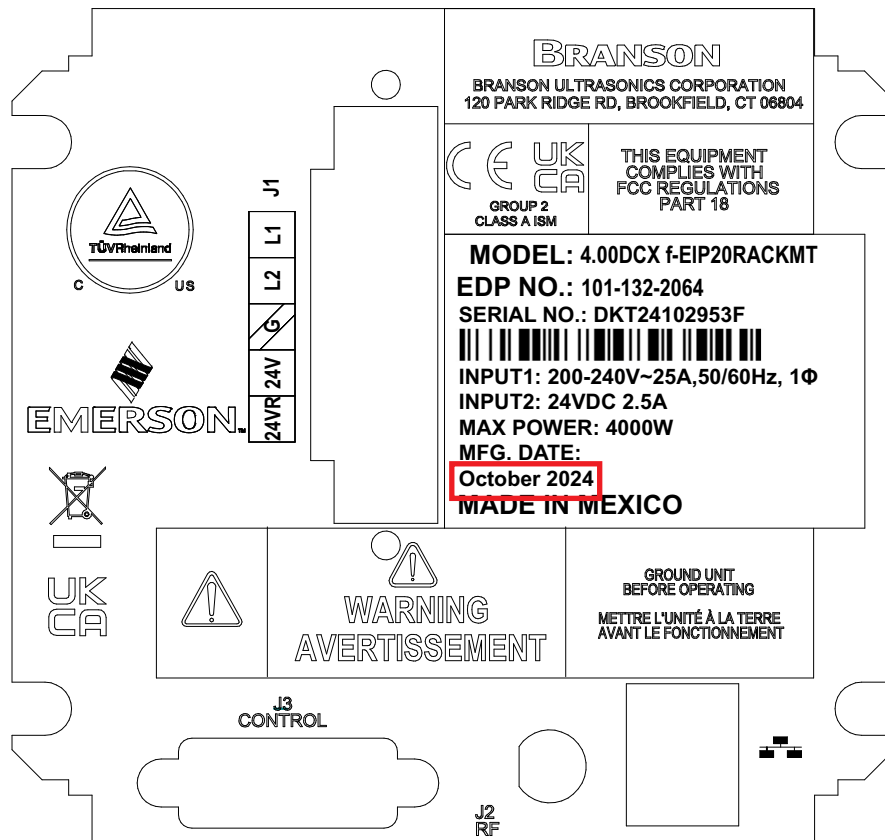
## B.1 Manual's Revisions

Refer to the table below for the appropriate manual revision depending on your Power Supply's manufacturing date.

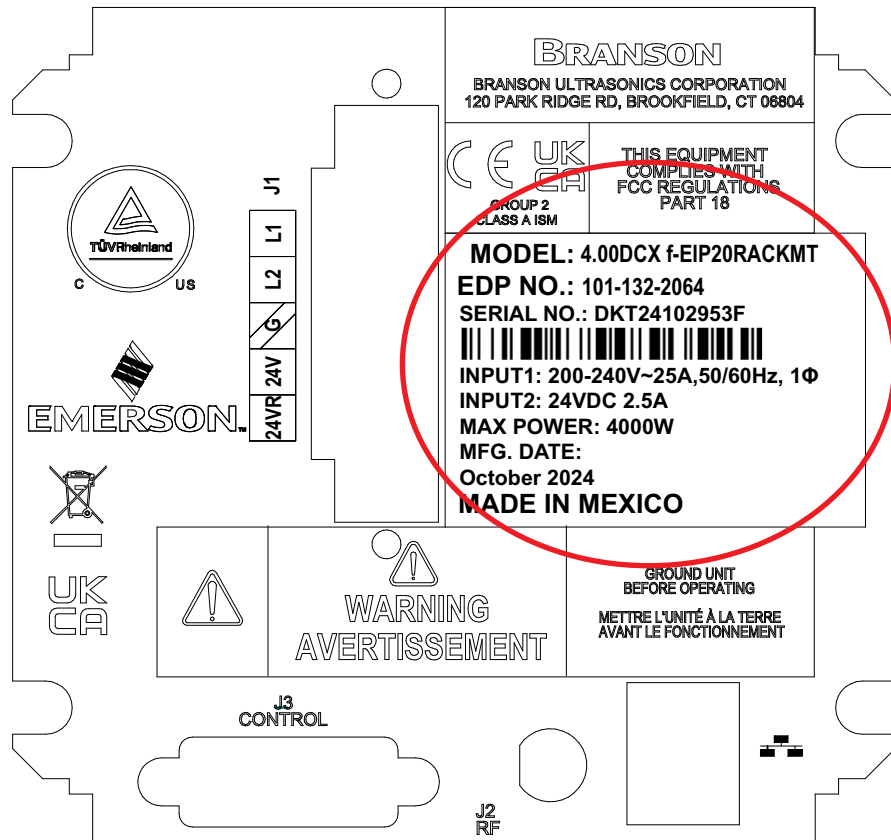
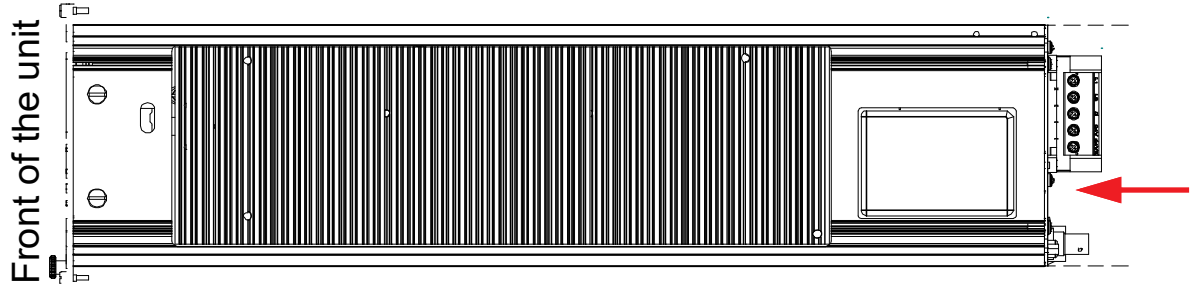
**Table B.1** Manual's Revisions

Manual's Revisions	Power Supply's Manufacturing Date	
	From	To
00	May 2022	March 2026
01	April 2026	To date

**Figure B.1** Manufacturing date on the Information label



**Figure B.2** Location of the Information label on the back of the DCX 222 RM SIG Power Supply





---

# Index

---

## Symbols

+Peak Power Window Limit 77

## A

about Installation 38  
Actuator 23  
Alarm 23  
alarm  
    configuring 52  
    latching 52  
    modes 52  
Amplitude 23  
amplitude  
    start ramp 52  
Amplitude Control 23  
applications 22  
autotune with memory (AT/M) 11  
Autotuning 13

## B

bar graph 92  
    frequency interpretation 93  
    power interpretation 92  
bend radius 42  
Booster 23  
booster 15  
    dimensions 34, 62  
    part numbers 109

## C

cables  
    bend radius 42  
    RF 49  
    user I/O 45  
Clamping Force 23  
Cold Start 23  
cold start 112  
components  
    functional description 66  
connection  
    input power 52  
    user I/O 45  
connector  
    line 20  
    RF 21  
    user I/O 21  
controls, front panel 16  
Converter 23

- converter 15, 66
  - cooling 57
  - dimensions 34, 62
  - part numbers 109
- Counters 23

## D

- Degating 23
- Digital Amplitude Setting 13
- drop test 26

## E

- electrical input
  - operating voltages 33
- Energy Director 23
- environmental
  - requirements 41
  - specifications 26
- External Amplitude Control 23
- External Frequency Control 23

## F

- Fixture 23
- Flash 23
- Forming 23
- Frequency 23
- frequency
  - end of weld store 52
  - offset 11
- Frequency Offset 13, 24
- frequency offset
  - setup 53
- Fretting Corrosion 23

## G

- Gain 24

## H

- Horn 24
- horn 15
- Horn Amplitude 24
- Horn Signature 13, 24
- humidity 26, 32, 41

## I

- indicators 16
- input power 49, 50
  - plug 52
  - ratings 33, 41
- inputs
  - analog 47
- Insertion 24
- installation 37
  - requirements 39
  - stack 58

- steps 42
- testing 58
- Interface 24
- inventory of small parts 29

## **J**

- Joint 24

## **L**

- LCD 13
  - bar graph 92
    - frequency interpretation 93
    - power interpretation 92
  - description 18
  - viewing angle 43
- line input
  - connector 20
- Line Regulation 13
- line regulation 11
- Load Regulation 13
- load regulation 11

## **M**

- maintenance 101
  - general considerations 102
- manual set 11
- Membrane Keys 13

## **O**

- operating voltages 33
- operation 69
  - principle of 22
- output power cable 49
- outputs
  - analog 48
  - digital 47

## **P**

- Parameter 24
- Parameter Range 24
- parts lists 109
- Passcodes 13
  - Peak Power Window Limit 80
- Peak Power Window Limits 77
- periodic and preventive maintenance
  - periodically clean the equipment 104
  - recondition the stack 105
  - routine component replacement 109
- Power Supply 24
- power supply
  - configuring 86, 87
  - connections 20
  - cycle rate 34
  - default settings (cold start) 112
  - front panel controls 16

- manual set 11
- models 10, 11
- mounting 43

## R

- Ramp Starting 13
- receiving the equipment 27
- returning equipment 30

## S

- safety
  - general precautions 6
  - maintenance 102
  - symbols, meaning 2
- Seek 14, 24
- seek
  - ramp time 52
  - timed 11, 53
- shipping and handling 26
- shock 26
- solid mount boosters 67
- special cable requirements 43
- stack 15, 66
- stack assembly 54
  - 20 kHz 56, 107
- Staking 24
- Start-up Diagnostics 14
- support 59
- Swaging 24
- System Protection 14
- system requirements, web page interface 94

## T

- technical specifications 31, 61
- temperature
  - ambient operating temperature 32, 41
  - shipping and storage 26, 32
- Thermoplastic 24
- Thermoset 24
- Timed Seek 14
- timed seek 11
- Token 24
- troubleshooting
  - electrical problems 110
  - ultrasonic power 111
  - weld cycle problems 112
- True Wattmeter 14

## U

- Ultrasonic Power 24
- ultrasonic stack 66
- Ultrasonic Welding 24
- unpacking 28
- User ID 13, 24

## **V**

vibration 26

## **W**

Web Page Interface 14  
web page interface 11, 98  
  point-to-point connection  
    Windows 10 or Windows 11 94  
Weld Parameters 70  
Weld System 24  
weld system  
  applications 22  
welding systems 22

