

Ultrasplice 40

Metal Welding System

Product Manual

Branson Ultrasonics Corp.
120 Park Ridge Road
Brookfield, CT 06804
(203) 796-0400
<http://www.bransonultrasonics.com>



Introduction

This is the product manual for your BRANSON Metal Welding ultrasonic welding system.

Several combined Instruction Sets form the contents of this manual. This section contains information which relates most uniquely to you as the customer, your particular system and application. It also documents other Instruction Sets used in the manual. The figure below illustrates how the manual is organized.

Branson Metal Welding Product Manual

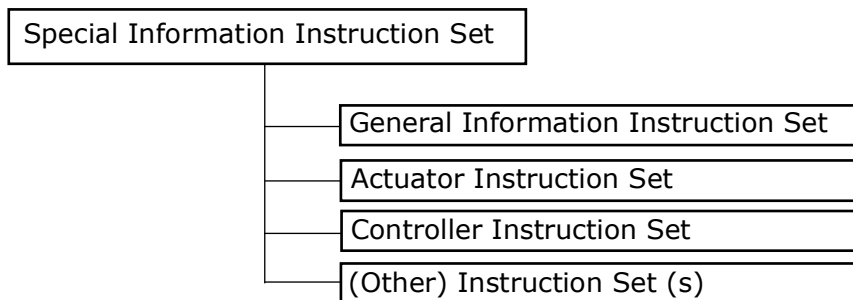



Using this manual

It is highly recommended that you read and understand the contents of this manual prior to operating your Branson Metal Welding system. Each Instruction Set has a table of contents and is intended to logically group information in a manner which the user will find convenient.

Classification of Hazards

The safety indications in this manual are divided into different classes. The figure below shows the assignment of symbols (pictograms) and signal words to the specific hazards and its potential consequence.

WARNING	
	A potentially dangerous situation that could cause injury to persons and serious damage to equipment.

CAUTION	
	A situation that may cause damage to the equipment.

NOTICE	
	Useful information, an application hint or other important or useful information.



EMERSONTM

Original Instructions
DCM00003 - REV. 07

MWX100 / Ultrasplice Systems

Instruction Manual

Branson Ultrasonics Corp.
120 Park Ridge Road
Brookfield, CT 06804
(203) 796-0400
<http://www.bransonultrasonics.com>

BRANSON

Introduction

This Instruction Set includes common information which relates to Branson products. It will help you in setting up your system and to understand the fundamentals of the ultrasonic metal welding process.

Thank You

Thank you, and congratulations on selecting Branson MWX100/ ULTRASPLICE Systems for your welding production. This system has been developed to produce the highest quality welds at the lowest cost per weld.

If you should experience difficulty or have any recommendations for improvement, please do not hesitate to contact us.

Please be advised that the MWX100/ ULTRASPLICE machine is protected under the United States and International patents listed below. This operator's manual is also protected by copyright and may not be copied without prior written permission by Branson.

Trademarks

MWX100 and ULTRASPLICE are registered trademarks of Branson Ultrasonics Corp.

Copyright

MWX100 Computer Software and the MWX100 Manual are copyrighted 1994, 1995, 1996, 1997 by Branson Ultrasonics Corp.



Table of Contents

Chapter 1: Safety and Support

1.1	Intended Use	2
1.2	Safety, Personal	3
1.3	Maintenance Safety	4
1.4	Safety, System	5
1.5	Contacting Branson	6
1.6	Warranty	8

Chapter 2: Introduction

2.1	Ultrasonic Theory	10
2.2	Terminology	16

Chapter 3: Shipping and Handling

3.1	Unpacking, Handling & Installation	22
-----	--	----

Chapter 4: Troubleshooting

4.1	Troubleshooting	26
4.2	Weld Overload	27
4.3	Low Air Pressure	28
4.4	Ready Check	29
4.5	Troubleshooting Guide	30

Chapter 5: Maintenance

5.1	Periodic Maintenance	34
-----	--------------------------------	----



List of Figures

Chapter 1: Safety and Support

Chapter 2: Introduction

Figure 2.1	Transforming Electrical Energy into high frequency mechanical vibration	10
Figure 2.2	High frequency vibration Welding	10
Figure 2.3	Weld 'power graph' (weld footprint).	12
Figure 2.4	Pressure, Power, and Time relationship	12
Figure 2.5	Weld Time	13
Figure 2.6	Amplitude.	13
Figure 2.7	Power, Time, and Energy relationship	14
Figure 2.8	Resonant Frequency	14

Chapter 3: Shipping and Handling

Chapter 4: Troubleshooting

Chapter 5: Maintenance

List of Tables

Chapter 1: Safety and Support

Chapter 2: Introduction

Chapter 3: Shipping and Handling

Chapter 4: Troubleshooting

Table 4.1 Troubleshooting Guide 30

Chapter 5: Maintenance



Chapter 1: Safety and Support

1.1	Intended Use	2
1.2	Safety, Personal	3
1.3	Maintenance Safety	4
1.4	Safety, System	5
1.5	Contacting Branson	6
1.6	Warranty	8

1.1 Intended Use

This equipment is for the joining of metal parts using ultrasonic energy. A complete system includes an actuator, controller and tooling (which delivers mechanical energy to the work pieces). Some systems also include special fixturing and machine automation. Branson systems may only be utilized to weld soft, ductile, metal parts together with Branson-supplied weld tooling (such as horns, tips, anvils, and converters) unless an explicit, written, contrary agreement between the ordering party and Branson has been consummated.

1.2 Safety, Personal

1.2.1 Safety Devices

The removal, bridging or disabling of safety devices is not condoned for production operation. Individual safety devices mentioned below may only be disabled if super-ordinate safety devices are employed in their place.

1.2.2 Emergency Stops

In case of danger, hit the red, emergency stop which is found on the red, top portion of the foot pedal. The actuator, power supply and related fixturing are returned to the "Home" position. If dual anti-tie start buttons are used, there must be a red emergency stop associated in line. Free access to the emergency stop button must be maintained.

1.2.3 Controller Cover

The power supply is equipped with a top cover which should only be removed for maintenance and installation purposes.

1.2.4 Safety Guidelines

For operating safety, please observe the following precautions:

- Plug the power supply into a grounded electrical supply to avoid electrical shock
- Ensure that no one is in contact with system moving parts when operating
- Keep hands away from the horn tip as high force and ultrasonic vibration can cause injury to hands and fingers
- Do not test ultrasonics when the converter is removed from the actuator. Without the converter there is the danger of damage or shock
- Before adjusting or repairing the ultrasonic stack or power supply, disconnect the line power
- Any unauthorized modification of the units control circuitry or wiring may cause a malfunction, which could result in injury to operating personnel
- Do not operate the equipment until repairs and adjustments have been made and the equipment is in good working order

1.3 Maintenance Safety

Safety devices, especially covers, guards and ground cables should only be removed when it is absolutely essential for the completion of maintenance work. If safety devices were removed prior to starting maintenance work, be sure to re-install those devices after finishing the maintenance work. The following installation and maintenance operations must be performed prior to any disassembly of equipment:

- All system components must be disconnected from the main electrical supply
- Remove the plug from the main electrical supply and secure it from being re-inserted accidentally
- All system components must be disconnected from the main air supply
- Disconnect the air hose from the main air supply and release system air pressure via the pressure regulator

1.4 Safety, System

1.4.1 System Protection Monitoring (SPM)

The SPM (System Protection Monitoring) stops ultrasonics when the power supply has been overloaded or when inappropriate or defective horns are used.

1.4.2 Thermal Switch

A thermal switch is contained within the power supply to automatically disconnect power to the machine if the unit gets too hot. This will occur if the exhaust fans from the generator are inadvertently blocked or clogged.

1.4.3 Daily Functional Safety Checks

- Check the machine tip and anvil for any signs of grinding, cracking, or galling that could be the result of misalignment or tooling contact. Replace tooling that has excessive wear
- Check for any loose material or debris in the welding cavity, cleaning it out
- Check all parameter settings on the controller to ensure they are properly set for the weld to be made
- Drain water and contaminants from the airline filters as necessary

1.5 Contacting Branson

1.5.1 Spare Parts & Replacement Tooling

Spare parts or replacement tooling for the ultrasonic welding system may be ordered directly from Branson. A spare tooling specification sheet is included in the Special Information Instruction Set. Additional part listings are contained in the Actuator and Touchscreen Controller Instruction Set sections of this manual.

Branson will work with you and recommend components you need and should carry in inventory based upon your manufacturing philosophy and or production needs. We will quote price, delivery and can coordinate special arrangements such as expedited service or blanket orders.

When Ordering Spare or Replacement Parts, have the purchasing agent Fax the order to us with the following information provided:

- Purchase Order Number,
- Branson Part Number, Quantity, and Date Required,
- Ship To Information, (including "Ship to the Attention of")
- Bill To Information
- Shipping Instructions, (such as air freight, truck, etc.)
- Special Instructions, (such as "Hold at Pick-Up Counter and Call" -- Be sure to provide a name and a phone number)

1.5.2 Questions or Problems

If you have any questions or are experiencing a problem, call the local Branson field sales and/or service representative. He or she will be familiar with your equipment and application and, in most cases, will be able to help you. He or she may have the replacement part you need, in stock, that will return your system to operation in the shortest possible time.

If necessary, the representative will contact Branson for additional service and, in some cases, will put you into contact with the appropriate personnel. If the local representative is unavailable, please call us directly.

Before you call, take the following steps:

- Have this manual with you
- Know how your system has been set up and equipped, including your MBOS version
- Be able to describe the situation or problem
- Have a list of steps that you have already taken
- Have a list of spare parts in your inventory
- Have the name and phone number of the Local Branson Representative

1.5.3 Returning Equipment

In order to properly and efficiently handle an equipment return to Branson, the following procedure must be followed. Contact your Local Sales Manager or Branson Customer Service for assistance. Proper handling and identification of your equipment will expedite servicing and/or return.

Call Branson and Receive a Return Authorization Number (RA#) from Branson Customer Service.

- Properly package the equipment to prevent damage
- Clearly mark the RA# on the outside of the package
- Include a copy of the completed Return Authorization Form inside the package
- Return general repairs by any convenient method. Send priority repairs via Air Freight
- Prepay the transportation charges, (FOB Brookfield, CT)

Complete the following in the Return Authorization Form:

- Customer Information Section
- Description of Problem
- Equipment Information

1.5.4 New Applications

Branson is always eager to work with you on a new ultrasonic application. Whether it be a manual workstation, a semi or fully automated system, Branson has the personnel and technical competence to support your requirements. Branson's application laboratory, product and automation engineering, customer service and manufacturing capabilities are second to none. Branson is the world leader in ultrasonic metal welding and our business philosophy is practiced to assure customer success.

Application assistance is always available. For initial application review, contact your Local Sales Manager who can indicate initial feasibility and assist you in completing an Ultrasonic Weld Evaluation Request For. Please complete one (1) request form for each application.

Please fill out the Ultrasonic Evaluation Request Form, complete the customer and application information section and forward it to Branson along with enough component material to produce 24 assemblies, (if this is not practical please advise). A feasibility evaluation will be performed and samples returned, for review, along with a system quotation/ proposal. Be sure to include drawings of the completed assembly and include the electrical, mechanical, and production requirements. Complete the form as completely as possible. The Branson Sales Representative can assist you.

1.6 Warranty

For warranty information please reference the warranty section of Terms and Conditions found at: www.emerson.com/branson-terms-conditions.

Chapter 2: Introduction

2.1	Ultrasonic Theory	10
2.2	Terminology	16

2.1 Ultrasonic Theory

What Is An Ultrasonic Weld?

Ultrasonic welding joins metal parts by applying the energy of high frequency vibrations onto the interface area between the parts to be welded.

How Does It Work?

Electrical Energy is transformed into high frequency mechanical vibration. This mechanical vibration is transferred to a welding tip through an acoustically tuned horn ([Figure 2.1](#)). The parts are "scrubbed" together under pressure at 20,000 or 40,000 cycles per second. This high frequency vibration, applied under force, disperses surface films and oxides, creating a clean, controlled, diffusion weld ([Figure 2.2](#)). As the atoms are combined between the parts to be welded, a true, metallurgical bond is produced.

Figure 2.1 Transforming Electrical Energy into high frequency mechanical vibration

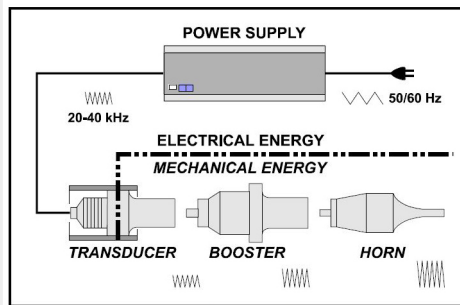
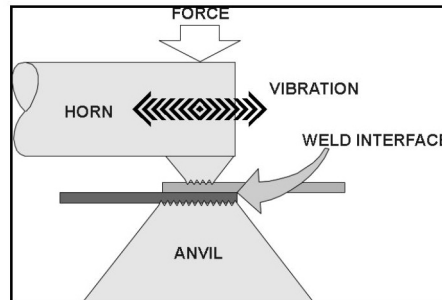

Figure 2.2 High frequency vibration Welding



Benefits of Ultrasonic Welding

Ultrasonic metal welding exhibits unique welding properties that include:

- Excellent electrical, mechanical, and thermal connections between similar and dissimilar metals
- Low heat build up during the ultrasonic process (no annealing of materials)
- Compensation for normal surface variations of the material
- Ability to clean surface oxides and contaminants prior to welding
- Ability to weld large areas using minimal energy
- Ability to weld thin materials to thick materials
- Low cost per weld

How Is An Ultrasonic Weld Made?

Although the theoretical process of producing an ultrasonic weld is uncomplicated, the interactions of the various weld parameters are important and should be understood.

When producing an ultrasonic weld, there are three primary variables that interact; they are:

Time: The duration of applied ultrasonic vibration

Amplitude: The longitudinal displacement of the vibration

Force: The compressive force applied perpendicular (normal) to the direction of vibration.

Power required to initiate and maintain vibration (motion) during the weld cycle can be defined as:

$$P = F \times A$$

Where:

- P = Power (watts)
- F = Force * (psi)
- A = Amplitude (microns)

NOTICE	
	<p>Force is determined by multiplying: Force = (Surface Area of the Cylinder) X (Air Pressure) X (Mechanical Advantage)</p>

Energy is calculated as:

$$E = P \times T$$

Where:

- E = Energy (joules)
- P = Power (watts)
- T = Time (seconds)

Thus the complete 'Weld To Energy' process would be defined as:

$$E = (F \times A) \times T$$

A well designed ultrasonic metal welding system will compensate for normal variations in the surface conditions of the metals by delivering the specified energy value. This is achieved by allowing Time (T) to adjust to suit the condition of the materials and deliver the desired energy.

Welding To Energy - Why?

Most metal welding applications are produced by 'Welding To Energy' in order to compensate for the various surface oxides and contaminants associated with the metals being joined. In a few applications 'Welding To Time' or 'Welding To Height' will yield better results. Since the majority of all metal welds are produced using energy as the controlling factor we will confine our discussion to that condition.

Welding to energy is necessary because of the non-metallic oxides that form on the metal's surface as well as other contaminants such as grease and dirt. To producing quality welds reliably it is necessary that the surfaces to be joined are clean. The high frequency scrubbing action, combined with pressure, cleans the weld interface at the beginning of the weld process.

The following graph ([Figure 2.3](#)) illustrates a weld produced. The weld 'power graph' is sometimes referred to a weld 'footprint'. It can be used to visualize the weld cycle and assists in parameter optimization. Graphs from consecutive welds will vary slightly as the system dynamically adjusts time to accommodate varying surface conditions. The weld power data is gathered by sampling the power used in 5 millisecond intervals.

Power

The converter/ booster/ horn, (stack assembly), requires minimal electrical power to initiate and maintain motion (vibration) at a 'no-load' condition. As the mechanical load increases, the power required to maintain the mechanical vibration also increases. The maximum power required during a weld cycle is 'Peak Power'.

Figure 2.3 Weld 'power graph' (weld footprint)

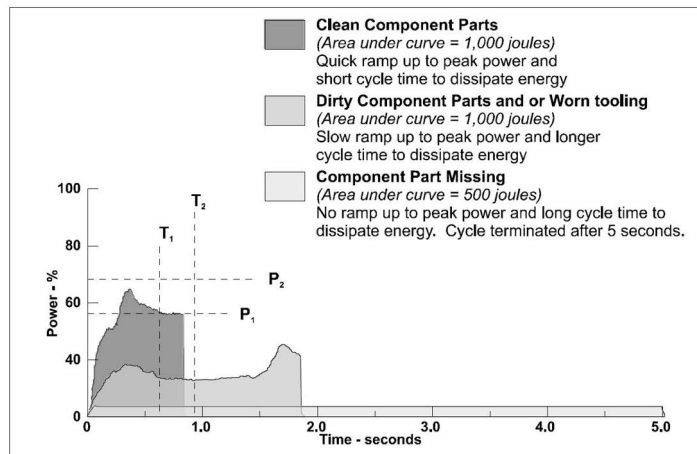

By increasing Pressure and maintaining all other parameters, the mechanical load or force on the weld joint increases, therefore, the amount of Power required to maintain the vibration of the stack increases. Subsequently, because of the increased Power Level, less time is required to deliver the same amount of Energy. This relationship is illustrated in the following diagram ([Figure 2.4](#)):

Figure 2.4 Pressure, Power, and Time relationship

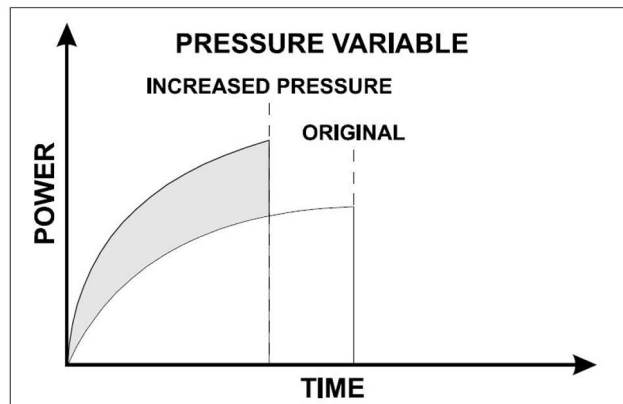

The difference in the appearance of each of the above weld graphs is the result of increased Power loading. Based upon an increase in Pressure, additional Power is required to maintain the motion of vibration. Thus, the same amount of energy is delivered in less time. This approach is typically used to raise the loading of the power supply during a weld cycle to the desired level as determined by the application.

Time

The time required to deliver the necessary energy is defined as the Weld Time. For most welds, the time required will be less than one second. If more energy is required and all other weld parameters are maintained, the weld time will increase ([Figure 2.5](#)).

Figure 2.5 Weld Time

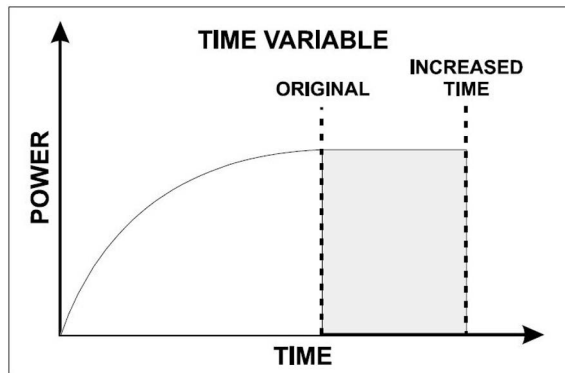

Amplitude

An ultrasonic tool is a resonant acoustical device. The term Amplitude is used to describe the amount of longitudinal expansion and contraction that the tooling endures as it vibrates ([Figure 2.6](#)). The amplitude correlates to the scrubbing action at the weld interface. This scrubbing action combined with pressure is what advances the weld by a diffusing or mixing of the base materials.

Figure 2.6 Amplitude

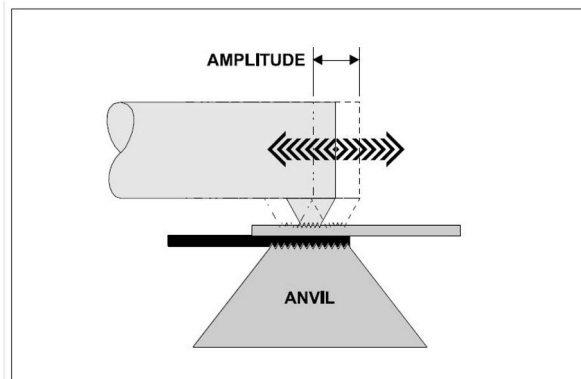

As previously mentioned, the converter/ booster/ horn, (stack assembly), requires minimal electrical power to initiate and maintain vibration in a 'no-load' condition. As the amplitude increases, the power required to maintain the increased velocity of vibration also increases.

Subsequently, because of the increased Power less time is required deliver the same amount of Energy. This relationship is illustrated in the power diagram ([Figure 2.7](#)):

Figure 2.7 Power, Time, and Energy relationship

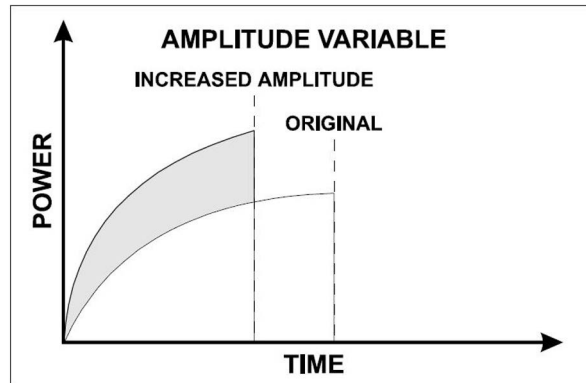

Resonant Frequency

The ultrasonic tooling acts as a spring having node points and anti-node points. The mechanical energy used to vibrate the tool is created by the converter. As the vibrations are propagated through the acoustical tool, a harmonic resonance is established consisting of nodes and anti-nodes. This action results in a resonant wave being transferred through the tooling ([Figure 2.8](#)). The efficiency of the resonant wave transfer depends on the natural resonant frequency of the horn and is determined by two factors:

- The speed of sound through the material
- The geometric shape of the object

Figure 2.8 Resonant Frequency

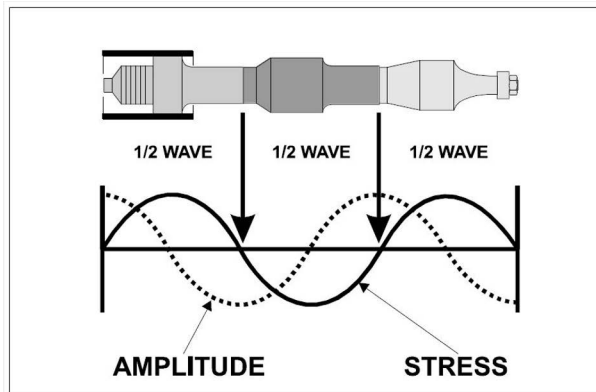

Avoiding An Overload Condition: It is possible to increase the Amplitude and or the Pressure to a point where the power available is not adequate to initiate or maintain vibration under the given mechanical load. At this point, the power supply will stall resulting in an Overload condition. Electronic circuits in the system will protect the power supply if this condition exists.

Welding To Time: In specific applications, 'Welding To Time' may be desired. As previously mentioned, there are three primary variables that interact; they are:

- **TIME:** The duration of applied ultrasonic vibration
- **AMPLITUDE:** The longitudinal displacement of the vibration
- **FORCE:** The compressive force applied perpendicular (normal) to the direction of vibration

Generally, welding for a specific time will produce acceptable results when:

- The equipment is installed on an automated production line and each station must complete its process within a certain time limit
- Very small low energy welds on clean components are being made

Welding Temperature: Ultrasonic welding produces a localized temperature rise from the combined effects of elastic hysteresis, interfacial slip and plastic deformation. The weld interfaces reach approximately 1/3 the temperatures needed to melt the metals. Since the temperature does not reach the melting point of the material, the physical properties of the welded material are preserved. As the ultrasonic welding process is an exothermic reaction, as welding time increases so does weld temperature.

2.2 Terminology

Actuator: A mechanical device which houses the converter/booster/horn (stack) assembly in a rigid mounting and is utilized to move the stack up or down. This allows for precise control of welding pressure for efficient while delivering mechanical vibrations from the ultrasonic stack to the work piece(s).

After Burst: A short duration (burst) of ultrasonic energy that begins after completion of the AFTER BURST DELAY. (Also See: AFTER BURST DELAY & AFTER BURST DURATION).

After Burst Delay: The amount of time, in seconds, between the completion of the ultrasonic welding cycle and the start of the AFTER BURST. (Also See: AFTER BURST & AFTER BURST DURATION).

After Burst Duration: The amount of time, in seconds, that AFTER BURST energy is delivered. (Also See: AFTER BURST & AFTER BURST DELAY).

Amplitude: Amplitude is the peak-to-peak displacement of mechanical motion as measured at the face of the horn tip. Amplitude is measured in thousandths of an inch or in microns. (i.e. A standard 40 kHz converter produces approximately .0004" or 10 microns of amplitude), Inches x 25,400 = microns. -- With 'Advanced Power Supply' this is adjustable depending on system frequency and application tooling.

Anti-Node: The anti-node is the area of the horn and booster that exhibits maximum longitudinal displacement and where the internal dynamic forces are equal to zero. This area is at the face and back surface on half-wave technology.

Anvil: A device specially designed to grip the lower component and hold it stationary against the energy of vibration(s) which allows a weld to be created.

Baud Rate: A communications measure describing the speed at which signals are transmitted serially (the number of signal events per second).

BBRAM: Nonvolatile random access memory (battery back-up random access memory). Equipped with long life built in batteries, this memory area preserves weld parameters and menu settings when the system is powered off. (also known as BBR).

Booster: The central component of an ultrasonic stack assembly. A device which transfers mechanical energy from the converter to the ultrasonic horn. The booster will, depending on design, increase, decrease, or maintain the specific energy (amplitude) as received from the converter.

Calibration: The process of adjusting a device to a known position for purposes of inspection and/or monitoring position, direction, speed, and/or velocity.

Clock: An electronic circuit that generates timing pulses to synchronize the operations of various other circuits in a device(s).

Communications: Transmission of information between points of origin and reception without alteration of the sequence and or structure of that information content.

Consumable Spare Tooling: The tooling portion of the ultrasonic system that wears and requires replacement due to production use. This includes but is not limited to ultrasonic horns, replaceable tips, anvil, and positioning mask. A Spare Tooling Specification Sheet is included within the Operation Manual to document the spare tooling for a specific metal welding application.

Continuous Sonics Mode: A system setting in which the power supply will deliver ultrasonic electrical energy until the start signal is terminated.

Controller: The portion of the welding system that provides specific settings & instruction(s) to the overall welding system.

Converter: A device which utilizes a lead-zirconate-titanate electrorestrictive element to change high frequency electrical energy into high frequency mechanical energy.

Counter: A programmable device used to monitor system cycles and alert personnel when specific conditions are met.

Data: Any representation(s) of instructions, characters, information, or analog quantities to which meaning may be assigned.

Default: A chosen system setting or parameter in which the system does not require external data input. In some cases the default value will be changed based upon equipment use.

Dynamic Spring: An, adjustable, energy storage mechanism (shock absorber) which allows for stack follow through upon engagement of application tooling with the work pieces to be welded.

Energy: Energy is the area beneath the ultrasonic power curve and is calculated in joules, (Watts X Seconds = Joules). When the ultrasonic welding system is setup in the "Weld In Energy" mode the system will deliver the amount of energy as programmed. **NOTE:** The maximum (default) time allowed for delivering ultrasonic energy is five (5) seconds.

Energy Mode: A welding method in which the ultrasonic power supply is active until the required amount of energy is delivered (See ENERGY).

Fixture: A device for positioning and or holding a component for assembly.

Force: The amount of mechanical pressure that is used to deliver, (bring down) the mechanical actuator. This programmed force is also called TRIGGER FORCE and is used to engage the knurl pattern into the component part(s) prior to the initiation of ultrasonic energy.

Frequency: The number of complete oscillations per second expressed in Hertz (Hz) or kilohertz (1 kilohertz = 1000 Hz). Typically 20 kHz or 40 kHz.

Gain: The ratio of the amplitude of motion produced by the converter and delivered by the horn is called the gain. It is determined by the difference in mass on either side of the nodal point.

Hand Shaking: The procedure (signal exchange) when a connection is established between two electronic devices. A common example is the signal exchange between a terminal and a MODEM. These signals (hardware and software) are used to control the flow of data (start/stop) between devices.

Height: A display value, in millimeters (mm), as registered by a linear encoder upon completion of an ultrasonic welding cycle. -- Programmable, in millimeters, with Upper Control Limit & Lower Control Limit.

Height Encoder: A device utilized to monitor position, direction, speed, and/or velocity.

Horn: An acoustically designed metal tool that delivers mechanical energy from the converter/ booster into the work piece. Most applications utilize half wave technology, (40 kHz = 2.2" ±, 20 kHz = 5.5" ±).

Hold Time: The amount of time after delivery of ultrasonic energy until the stack tooling begins to retract from the component material(s).

Joint: The welded surfaces.

Linear Height Encoder: (See: Height Encoder).

Loading Meter: A meter which indicates the power drawn from the ultrasonic power supply.

Maintenance Counter: A programmable device used to alert production personnel of the need to review / inspect application tooling and/or the ultrasonic system for preventive maintenance purposes. The device increments one (1) count for each system cycle. (See: Counters).

Mode: The method of operating the system (also see WELDING MODE).

Node: The node is the area of the horn, (and booster), that exhibits no longitudinal displacement and where the internal dynamic forces are at the maximum. This area is in the center location on half-wave technology.

Parameter(s): Programmable units used to control and or monitor the ultrasonic process. -- Include but not limited to ENERGY, FORCE, PRESSURE, AMPLITUDE.

Parts Counter: A programmable device used to monitor system cycles and alert personnel when specific conditions are met. (See: Counters).

Peak Power: Peak power is the maximum amount of power in watts that was required to keep the ultrasonic stack in motion during the weld cycle.

Power: Power, measured in watts, is a function of pressure and amplitude. The amount of power, (watts) required to keep the ultrasonic stack in motion is monitored and used to develop a power curve. This power curve is used to calculate the amount of energy delivered/ dissipated, (Watts = Joules / Time). The power as displayed on the control box is peak power.

Power Supply (Ultrasonic): An electronic device that converts 50/60 cycle electrical current into 40 kHz, (40,000) or 20 kHz, (20,000) cycles per second high frequency electrical energy.

Power Supply Overload (Ultrasonic): The point or limit at which the amount of power in watts, required to keep the ultrasonic stack in motion, exceeds the available power from the power supply. The system will go into an overload condition in order to prevent system damage.

Preheight: A pre-sonic inspection display, in millimeters (mm), as registered by a linear encoder prior to initiation of the ultrasonic welding cycle. -- Programmable, in millimeters, with Upper Control Limit & Lower Control Limit.

Presets: System memory available for storage and retrieval of welding parameters.

Pressure: The amount of mechanical pressure supplied to the ultrasonic stack assembly while delivering ultrasonic energy to the components.

Quality Widows & Limits: Programmable values used by the system to compare actual process data. Actual process data must be within limits or an alarm condition will exist.

Setup Mode: The condition the control box must be in prior to adjusting parameters, quality windows, and/or any others settings except those contained within the Command Mode.

Squeeze Time: The amount of time after the ultrasonic tooling engages the component(s) and before delivery of ultrasonic energy. -- Adjustable from 0 - 0.5 seconds

Stress: Stress is the amount of dynamic force per cross sectional area.

Time: Time is the duration of the ultrasonic, mechanical, activity. Time is a component used to calculate the amount of ultrasonic energy delivered during a weld cycle, (Time = Joules / Watts).

Tip: Device specially designed to grip the upper component, to be welded, and to direct the ultrasonic energy into the work piece, (Also: Horn Tip & Replaceable Horn Tip).

Tip Nut: Device specially designed to securely clamp a replaceable tip onto the horn.

Trigger Force: (See: Force).

Tuning: Adjusting to optimize power supply performance according to resonance frequency, especially with regard to the horn and converter.

Velocity: The rate of motion at a specific time [velocity = distance / time] (also referred to as speed).

Weld Mode:

- **Weld In Energy:** System delivers ultrasonic energy until a predetermined amount of energy, in joules is dissipated. The system determines energy by calculating the area beneath the power curve -- Watts x Time = Joules (1 watt per second = 1 joule).
- **Weld In Height:** System delivers ultrasonic energy until the ultrasonic tooling reaches a predetermined position.
- **Weld In Time:** System delivers ultrasonic energy for a predetermined amount of time.
- **Welding Parameters:** (See: Parameters).



Chapter 3: Shipping and Handling

3.1 Unpacking, Handling & Installation 22

3.1 Unpacking, Handling & Installation

Unpack the Actuator and Touchscreen Controller. Remove the top cover of the power supply and check if any components became loose during shipment.

3.1.1 If damage has occurred

Notify the shipping company immediately. Retain packaging materials for inspection and possible re-use.

3.1.2 System Location

Locate the Touchscreen Controller in an area away from radiators or heating vents. Allow sufficient clearance in back of the controller to access the connectors. Observe the following:

- Do not block the exhaust or air intake areas. Proper air circulation is necessary to maintain a safe operating temperature
- Only operate the controller within an ambient temperature range of 41°F to 122°F (5°C to 50°C)
- Verify that neither dust nor dirt are allowed to restrict the flow of air exhaust or air intake. Clean the air ports as necessary

If the temperature of the power supply exceeds the recommended operating range, a thermal switch will stop ultrasonics and the power supply will display an Overload alarm. Ultrasonics will remain off until the power supply cools to a safe operating temperature and the RESET button is pressed.

If the environment is excessively dirty or oily, contact Branson for assistance. Special Touchscreen Controller enclosures, filters (i.e. filter/separator/regulator), and other equipment are available.

3.1.3 System Assembly

Connect the actuator system per the Hookup diagram contained in the Special Information Instruction Set. Verify that connections are complete and correct before proceeding. Plug the Controller into a proper power source. See the Touchscreen Controller Instruction Set for power specifications, plugs and receptacles used.

To prevent the possibility of an electrical shock, always plug the power supply into a grounded power source. Be sure the power switch is in the Off position before making any electrical connections.

Connect the system to a clean (5 micron air filter with 0.5 micron mist separator), dry, 80 psig (5.5 bar) minimum air supply. See the Actuator Instruction Set for information on the set up of application tooling and the use of this equipment for ultrasonic welding.

3.1.4 Crash Gap Adjustment

In most applications, adjustment of the gap between the ultrasonic Horn Tip and the Anvil is factory set to prevent these surfaces from contacting each other when no parts to be welded are present and the foot pedal is depressed. A poorly adjusted crash gap can cause serious damage to the tooling. See the Actuator Instruction Set for proper setup instructions.

3.1.5 Operating the System

With all proper connections made and with tooling properly set up, welding may be performed. In most instances it is likely that Branson has developed weld settings for your application and stored them as presets in the controller prior to shipping. See the Touchscreen Controller Instruction Set for information on retrieving presets. For other

weld parameter information pertaining to your system, see the parameter preset page included in the Special Information Instruction Set.



Chapter 4: Troubleshooting

4.1	Troubleshooting	26
4.2	Weld Overload	27
4.3	Low Air Pressure	28
4.4	Ready Check	29
4.5	Troubleshooting Guide	30

4.1 Troubleshooting

This section shows how to fix some of the possible errors and problems which may occur in normal use of the MWX100/ Ultrasplice system.

4.2 Weld Overload

Weld overloads are premature shut downs of the power supply. Overloads signify excessive loads and must be corrected if continued reliability of the equipment is to be maintained. Hardware internal to the supply are controlling this function and it can not be defeated.

The control system analyzes the end of weld characteristics to check for overloads. If the system determines an overload an alarm occurs. The control halts action until the system is reset.

Some of the possible causes for overloads are:

- The tool clearances are too small, horn and anvil touch during welding
- Excessive air pressure with low amplitude
- Defective Stack assembly
- Defective Power Transistors in power supply

4.3 Low Air Pressure

The control system and its components were designed to run with a clean air supply of from 90 to 120 psi. The control system monitors the air pressure from the low air pressure switch (optional). The low pressure threshold is set from the controller. An alarm occurs when incoming line pressure the drops below the set pressure.

4.4 Ready Check

The system undergoes a Ready Check operation at every startup, the end of every weld, and at the exit of Setup mode. This procedure checks the height encoder position. If an incorrect height value is returned, an alarm occurs.

Some of the possible causes of a Ready Check alarm are:

- The horn is stuck in the closed position
- Maintenance has moved the height encoder to an out of limit condition
- Defective encoder or electronics
- Encoder not plugged in to its connector

4.5 Troubleshooting Guide

Table 4.1 Troubleshooting Guide

Problem	Solution
System will not turn on.	Power cable plugged in. Power turned on at the outlet. Check internal fuses on the Controller Line Board.
Plant fuse fails or circuit breaker trips when plugging the unit into an electrical outlet.	Inspect power cord, replace if shorted. Check line filter, replace if failed.
Plant fuse fails or circuit breaker trips during weld cycle.	Check current rating of the plant fuse or the circuit breaker, replace if failed.
Line fuse fails.	Check fuse current rating, replace if incompatible. Check fan motor, replace if failed.
Horn will not move down or up.	System not connected to air supply. Air not turned on.
Get Emergency Stop when system is turned on.	Check Emergency Stop Switch. All cables properly connected. Press red switch on foot pedal. (if system is equipped with one)
No Sonics when test button is pressed.	RF Cable connected. Check RF cable for broken wire. Ribbon cable in power supply between SPM and programmer unplugged.
No sonics during weld cycle.	Check all cable connections. Check start cable for broken wires. Check inside power supply for loose start cable from rear of unit to programmer board. Check thermo switch in power supply.

Table 4.1 Troubleshooting Guide

Problem	Solution
Overloads when welding.	Stack not tuned properly. Tooling not set up properly. Crash gap not set properly. Tip nut cracked, replace if needed. Check weld parameters. Check stack interfaces for fretting. Check for loose or failed horn or booster, tighten or replace as necessary.
When touching the system you get a slight electrical shock.	Inspect power cord, replace if needed. Inspect system ground, repair if needed.
Tooling heats up after machine runs a while.	Cooling air is not turned on or is not on long enough. Cooling air is not directed at tooling.
Low weld strength.	Check weld parameters. Check tooling gaps. Check knurl on tooling. If worn replace tooling. Increase Energy. Check the Down stop adjustment. Check for part contamination. Ensure all hardware is tight.
Excessive welding.	Reset parameters. Reset amplitude. Reset pressure. Measure and re-calibrate amplitude display.
Time limit error or peak power error displayed after weld cycle.	Reset limits. Check tip, rotate or replace if worn. Check anvil for wear, rotate or replace if worn. Check air pressure setting. Check up stop for proper adjustment. Process settings have to be opened up due to part variance or limits should be adjusted according to the part/wire being run. Check anvil clamp for proper torque.

Table 4.1 Troubleshooting Guide

Problem	Solution
Squealing sound during welding or when test key is depressed.	Check plate screws and tighten or replace. Check cover plate screws and tighten. Reset gaps. Re-square horn/tip and reset gaps. Reset horn tip and gap.
Weld heights are inconsistent.	Re-calibrate encoders with 1mm gauge. Ensure the connector for the encoder is tightly plugged into the actuator card.
Horn is stuck in down position.	Check air pressure. Ensure air lines are installed properly. Check for kinks in air lines.
Air leaking from machine.	Ensure all air line connections are tight. Check for cracked or broken air lines.
Unusual sound during weld cycle.	Check tooling gap. Check converter. Check stack assembly.
Squealing sound from power supply when unit is turned on.	Check cooling fans in rear of unit.
Maintenance counter alarm.	Reset maintenance counter.
Actuator arm moves sluggish.	Check air lines for contamination. NOTE: Air must be filtered to 5 microns and be oil and water free. Check solenoid valve, replace if needed. Check air regulator.
System has READY CHECK message.	The horn is stuck in the closed position. Maintenance has moved the height encoder to an out of limit condition. Defective encoder or electronics. Encoder not plugged into the actuator card.
Time, height and energy inconsistent.	Switch to energy mode & open height window. Make some sample welds. Check the time and the height of the welds for consistency. If the time or weld thickness varies greatly, check the air regulator.

Chapter 5: Maintenance

5.1 Periodic Maintenance 34

5.1 Periodic Maintenance

In order to maintain optimum operating conditions, it is important to perform various maintenance and equipment inspections at periodic intervals. Please observe the following recommendations.

Daily

- Drain water and contaminants from the airline filters, if required

Every Tool Rotation

- Inspect the clamping surfaces of the Tip, the Tip Nut and the Horn for fretting
- Vacuum and clean out any copper residue or dirt in the actuator

After 40k-50k Cycles Maximum (subject to change based on weld application):

- Vacuum and clean inside of power supply
- Calibrate pressure regulator
- Clean and torque the stack interface
- Calibrate amplitude

5.1.1 FSR Assembly

Air Filter/Separator/Regulator (Optional Branson Part #207-020) should be serviced after 1 year or when a pressure drop of 15 psi is reached.

- Disconnect the air supply
- Remove and clean out filter bowl with a clean rag
- Replace the white filter element and re-assemble
- Remove and clean out separator bowl with a clean rag
- Replace brass-colored filter element and reassemble
- Reconnect air supply

Do not use solvent to clean filter bowls.

CAUTION	
	Clean the air filter bowl with a mild household soap only. The bowl is made from a polycarbonate material, which can rupture if exposed to synthetic lubricating oils solvents or harsh chemicals. The bowl is rated for a maximum line pressure of 140 psig (1043 kPa) and a maximum temperature of 120°F (49°C).



EMERSONTM

Original Instructions
DCM00038 - REV. 08



Ultrasplice 40 Actuator

Operating Manual

Branson Ultrasonics Corp.
120 Park Ridge Road
Brookfield, CT 06804
(203) 796-0400
<http://www.bransonultrasonics.com>

BRANSON

Manual Change Information

At Branson, we strive to maintain our position as the leader in ultrasonics metal welding, plastics joining, cleaning, and related technologies by continually improving our circuits and components in our equipment. These improvements are incorporated as soon as they are developed and thoroughly tested.

Information concerning any improvements will be added to the appropriate technical documentation at its next revision and printing. Therefore, when requesting service assistance for specific units, note the Revision information found on this document, and refer to the printing date which appears on this page.

Copyright and Trademark Notice

Copyright © 2021 Branson Ultrasonics Corp. All rights reserved. Contents of this publication may not be reproduced in any form without the written permission of Branson Ultrasonics Corp.

Any trademarks and service marks mentioned herein are held by their respective owners.

Foreword

Congratulations on your choice of a Branson system!

The Branson Ultrasplice 40 Series system is process equipment for the joining of metal parts using ultrasonic energy. It is the newest generation of product using this sophisticated technology for a variety of customer applications. This Operating Manual is part of the documentation set for this system, and should be kept with the equipment.

Thank you for choosing Branson!

Introduction

This manual is arranged into several structured chapters which will help you find the information you may need to know to safely handle, install, set up, program, operate, and/or maintain this product. Please refer to the [Table of Contents](#) of this manual to find the information you may be looking for. In the event you require additional assistance or information, please contact our Product Support department (see [1.4 How to Contact Branson](#) for information on how to contact them) or your local Branson representative.



Table of Contents

Chapter 1: Safety and Support

1.1	Safety Requirements and Warnings	2
1.2	General Precautions	4
1.3	Warranty	6
1.4	How to Contact Branson	7
1.5	Returning Equipment for Repair	8
1.6	Obtaining Replacement Parts	10

Chapter 2: The Ultrasplice 40 Actuator

2.1	Model Covered	12
2.2	Overview of this Model	13
2.3	Features	16
2.4	Controls	17
2.5	Ultrasonic Theory	18
2.6	Terminology	24

Chapter 3: Shipping and Handling

3.1	Shipping and Handling	28
3.2	Receiving and Unpacking	29
3.3	Returning Equipment	30

Chapter 4: Installation and Setup

4.1	About Installation	32
4.2	Handling and Unpacking	33
4.3	Take Inventory of Small Parts	34
4.7	Ultrasonic Stack Assembly	42
4.8	Testing the Installation	53
4.9	Still Need Help?	54

Chapter 5: Technical Specifications

5.1	Technical Specifications	56
-----	------------------------------------	----

Chapter 6: Operation

6.1	Actuator Controls	58
6.2	Initial Actuator Settings	59
6.3	Operating the Actuator	61
6.4	Safety Circuit Alarms	66

Chapter 7: Maintenance

7.1	Periodic and Preventive Maintenance	68
7.2	Calibration	76
7.3	Troubleshooting	79
7.4	Parts Lists	83

Appendix A:Ultrasplice 40 Interconnect Diagram

Appendix B:Declaration of Conformity

Appendix C:Declaration of Incorporation



List of Figures

Chapter 1: Safety and Support

Figure 1.1	Safety Label found on the Ultrasplice 40 actuator	3
Figure 1.2	CE Mark	5

Chapter 2: The Ultrasplice 40 Actuator

Figure 2.1	The Ultrasplice 40 Actuator	13
Figure 2.2	Gather and Anvil	15
Figure 2.3	Application Tooling	15
Figure 2.4	How does Ultrasonic Welding Work?	18
Figure 2.5	Weld Power Graph for Clean Components, Dirty Components and when Part is Missing	20
Figure 2.6	Pressure Variable with Increased Power	20
Figure 2.7	Pressure Variable with Increased Time	21
Figure 2.8	Scrubbing Action on Weld Interface	21
Figure 2.9	Amplitude's Influence on Weld Power and Time	22
Figure 2.10	Harmonic Resonance on Ultrasonic Tooling	22

Chapter 3: Shipping and Handling

Chapter 4: Installation and Setup

Figure 4.1	Controller Dimensional Drawing (VersaGraphiX)	36
Figure 4.2	Controller Dimensional Drawing (Touch Screen)	37
Figure 4.3	Connections on Rear of a VersaGraphiX Controller	39
Figure 4.4	Connections on Rear of a Touch Screen Controller	39

Chapter 5: Technical Specifications

Chapter 6: Operation

Figure 6.1	Proper Wire Insertion	62
Figure 6.2	Percent Compaction vs Tensile Strength	65

Chapter 7: Maintenance

Figure 7.1	Exploded Ultrasonic Stack Assembly	70
Figure 7.2	Reconditioning Tip and Nut Clamping Surfaces	74
Figure 7.3	Encoder Board Calibration	76

Appendix A: Ultrasplice 40 Interconnect Diagram

Figure A.1	Ultrasplice 40 Interconnect Diagram	86
------------	-------------------------------------	----

Appendix B: Declaration of Conformity

Figure B.1	Declaration of Conformity	88
------------	---------------------------	----

Appendix C: Declaration of Incorporation

Figure C.1	Declaration of Incorporation	90
------------	------------------------------	----



List of Tables

Chapter 1: Safety and Support

Chapter 2: The Ultrasplice 40 Actuator

Table 2.1	Calculating Power	19
Table 2.2	Calculating Energy.	19

Chapter 3: Shipping and Handling

Table 3.1	Environmental Requirements	28
Table 3.2	Receiving and Unpacking	29

Chapter 4: Installation and Setup

Table 4.1	Standard small parts included with Controller and/or Actuator	34
Table 4.2	List of Cables	34
Table 4.3	Environmental Specifications	35
Table 4.4	Input Power requirements	38
Table 4.5	Ultrasonic Stack Assembly Procedure.	42
Table 4.6	Mounting the Stack on the UltraSplice 40 Actuator	44
Table 4.7	Adjusting the Down Stop	48
Table 4.8	Setting Anvil Width	49
Table 4.9	Other Tooling Gaps	50
Table 4.10	Rotating Tip	51

Chapter 5: Technical Specifications

Chapter 6: Operation

Chapter 7: Maintenance

Appendix A: Ultrasplice 40 Interconnect Diagram

Appendix B: Declaration of Conformity

Appendix C: Declaration of Incorporation



Chapter 1: Safety and Support



1.1	Safety Requirements and Warnings	2
1.2	General Precautions	4
1.3	Warranty.	6
1.4	How to Contact Branson	7
1.5	Returning Equipment for Repair.	8
1.6	Obtaining Replacement Parts.	10

1.1 Safety Requirements and Warnings

This chapter contains an explanation of the different Safety Notice symbols and icons found both in this manual and on the product itself and provides additional safety information for ultrasonic welding. This chapter also describes how to contact Branson Metal Welding for assistance.

1.1.1 Symbols Found in This Manual

These symbols used throughout the manual warrant special attention:

NOTICE	
	A Note contains important information. It does not alert the user to potential injury, but only to a situation that might eventually require additional work or modification if you ignore it initially.
CAUTION	
	A Caution indicates a potentially hazardous situation, which, if not avoided, can result in minor or moderate injury. It can also alert the user to unsafe practices or conditions that can damage equipment if not corrected.
WARNING	
	A Warning indicates a hazardous situation or practice that, if not avoided, can result in serious injury or death.

1.1.2 Symbols Found on the Product

The Ultrasplice 40 Actuator has several warning labels on it to alert the user of items of concern or hazard. The following warning symbols appear on the Ultrasplice 40 Actuator:

Figure 1.1 Safety Label found on the Ultrasplice 40 actuator





1.2 General Precautions

Take the following precautions before servicing the Controller:

CAUTION	
	<p>Be sure the power switch is in the Off position before making any electrical connections.</p>

- To prevent the possibility of an electrical shock, always plug the Controller into a grounded power source
- Controllers produce high voltage. Before working on the power supply module, do the following:
Turn off the Controller;
Unplug main power; and
Allow at least 2 minutes for capacitors to discharge
- High voltage is present in the Controller. Do not operate with the cover removed
- High line voltages exist in the ultrasonic power supply module. Common points are tied to circuit reference, not chassis ground. Therefore, use only non-grounded, battery-powered multimeters when testing these modules. Using other types of test equipment can present a shock hazard
- Be sure power is disconnected from the Controller before setting a DIP switch
- To prevent any possible electrical shock from the high voltage contact on the converter, ensure that the power supply is off before removing the actuator cover
- Do not cycle the welding system if either the RF cable or converter is disconnected
- Use extreme caution when loading parts into the fixture since a pinch point may exist between the horn and the anvil
- Do not operate the system without guards or covers in place

WARNING	
	<p>Sound level emissions of up to 84.9 dB have been measured using a standard test load. To prevent the possibility of hearing loss, use appropriate hearing protection.</p>

NOTICE	
	<p>Sound level and frequency of the noise emitted during the ultrasonic assembly process may depend upon a. type of application, b. size, shape and composition of the material being assembled, c. shape and material of the holding fixture, d. welder setup parameters and e. tool design. Some parts vibrate at an audible frequency during the process. Some or all of these factors may result in sound levels of up to 84.9 dB. In such cases operators may need to be provided with personal protective equipment. See 29 CFR (Code of Federal Regulations) 1910.95 Occupational Noise Exposure. For all other countries, follow your local regulations.</p>

1.2.1 Intended Use of the System

The Branson Metal Welding Controller and Ultrasplice 40 Actuator are components of an ultrasonic welding system. These are designed for a wide variety of welding or processing applications:

- Wire to wire
- Stranded Wire to resistor
- Magnet Wire to wire

1.2.2 Regulatory Compliance

The Branson Ultrasplice 40 Actuator is designed to be in compliance with the following U.S. regulatory and agency guidelines and standards:

- ANSI Z535.1 Safety Color Code
- ANSI Z535.3 Criteria for Safety Symbols
- ANSI Z535.4 Product Safety Signs and Labels
- ANSI Z535.6 Product Safety Information in Product Manuals, instructions
- NFPA 70 National Electric Code Article 670 Industrial Machinery
- NFPA 79 Electrical Standard for Industrial Machinery
- 29 CFR 1910.212 OSHA General Requirements for all machines
- 47 CFR Part 18 Federal Communications Commission
- The Branson Ultrasplice 40 Actuator is designed to be in compliance with the following European standards as specified by the Directives issued by the European Parliament and The Council of the European Union:
 - Machinery Directive 2006/42/EC
 - Low Voltage Directive 2006/95/EC as Amended
 - EMC Directive 2004/108/EC as Amended
 - BS EN ISO 13850 Safety of Machinery - Emergency stop equipment, Functional aspects - Principles for design
 - EN ISO 14121-1 Safety of Machinery - Risk assessment - Part 1: Principles
 - EN 13849-1 Safety of Machinery - Safety Related Parts of Control Systems
 - BS EN ISO 12100-1, -2 Safety of Machinery - Basic concepts, general guidelines for design
 - EN 55011 Limits and methods of measurement of radio disturbance of industrial, scientific and medical radio-frequency equipment
 - EN 60204-1 Safety of Machinery - Electrical Equipment of machines
 - EN 60529 Degrees of protection provided by enclosure
 - EN 60664-1 Insulation coordination for equipment within low-voltage systems
 - EN 61000-3-2 Electromagnetic Compatibility - Limits for harmonic emissions (For European products that draw less than 1000 watts from the line at full rated power)
 - EN 61000-3-3 Electromagnetic Compatibility - Limitations of voltage fluctuations and flicker in low voltage supply systems (For European products that draw less than 1000 watts from the line at full rated power)
 - EN 61000-6-2 Electromagnetic Compatibility - Generic standards - Immunity for industrial environments
 - EN 61310-2 Safety of Machinery - Indication, marking, actuation

All Ultrasplice 40 Actuators are CE Compliant (see [Figure 1.2](#) below).

Figure 1.2 CE Mark



1.3 Warranty

For warranty information please reference the warranty section of Terms and Conditions found at: www.emerson.com/branson-terms-conditions.

1.4 How to Contact Branson

Branson is here to help you. We appreciate your business and are interested in helping you successfully use our products. To contact Branson for help, use the following telephone numbers, or contact the field office nearest you.

- **Brookfield Main Number (all Departments):** (203) 796-0400 (Eastern Time Zone)
- **Parts Store:** Direct Number for Parts Store in Brookfield (203) 796-9807

Tell the operator which product you have and which person or department you need. If after hours, please leave a voice message with your name and return telephone number.

1.4.1 Before Calling Branson for Assistance

This manual provides information for troubleshooting and resolving problems that could occur with the equipment (see [Chapter 7: Maintenance](#)). If you still require assistance, Branson Product Support is here to help you. To help identify the problem, use the following questionnaire which lists the common questions you will be asked when you contact the Product Support department.

Before calling, determine the following information:

- Your company name and location
- Your return telephone number
- Have your manual with you
- Know your equipment model and serial numbers (found on a gray data label on the units). Information about the Horn (part number, gain, etc.) or other tooling may be etched into the tooling. Software- or firmware-based systems may provide a BIOS or software version number, which may be required
- What tooling (horn) and booster are being used?
- What are the setup parameters and mode?
- Is your equipment in an automated system? If so, what is supplying the "start" signal?
- Describe the problem; provide as much detail as possible. For example, is the problem intermittent? How often does it occur? How long before it occurs if you are just powering up? If an error is occurring, which error (give error number or name)?
- List the steps you have already taken.
- What is your application, including the materials being processed?
- Have a list of service or spare parts you have on hand (tips, horns, etc.)
- Notes: _____

1.5 Returning Equipment for Repair

Before sending equipment for repair, provide as much information with the equipment to help determine the problem with the system. Use the following page to record necessary information.

NOTICE	
	To return equipment to Branson, you must first obtain an RGA number from a Branson representative, or the shipment may be delayed or refused.

If you are returning equipment to Branson for repair, you must first call the Repair department to obtain a Returned Goods Authorization (RGA) number. (If you request it, the repair department will fax a Returned Goods Authorization form to fill out and return with your equipment.)

Branson Repair Department
120 Park Ridge Road
Brookfield, Connecticut 06804 U.S.A.
direct telephone number: (203) 796-0575
fax number: (203) 796-0574

- Provide as much information as possible that will help identify the need for repair
- Carefully pack the equipment in original packing cartons
- Clearly label all shipping cartons with the RGA number on the outside of cartons as well as on your packing slip, along with the reason for return
- Return general repairs by any convenient method. Send priority repairs by air freight
- You must prepay the transportation charges FOB Brookfield, Connecticut, U.S.A.

1.5.1 Get an RGA Number

RGA# _____

If you are returning equipment to Branson, please call the Repair Department to obtain a Returned Goods Authorization (RGA) number. (At your request, the Repair Department will fax an RGA form to fill out and return with the equipment.)

1.5.2 Record Information About the Problem

Before sending equipment for repair, record the following information and send a copy of it with the equipment. This will greatly increase Branson's ability to address the problem.

1. Describe the problem; provide as much detail as possible. For example, is the problem intermittent? How often does it occur? How long before it occurs after powering up?

2. Is your equipment in an automated system? NO / YES

3. If the problem is with an external signal, which signal? If known, include plug/pin # (e.g., P29, pin #3) for that signal

4. What are the Weld Parameters?

5. What is your application? (Type of weld, metal material, etc.)

6. Name and phone number of the person most familiar with the problem:

7. Contact the Branson office prior to shipping the equipment.

8. For equipment not covered by warranty, to avoid delay, include a Purchase Order.

Send a copy of this page with the equipment being returned for repair.

1.5.3 Contact Information

Call your local Branson Metal Welding Representative, or contact Branson by calling (203) 796-0400.

My Local Branson Representative's name is:

I can reach this representative at:

1.5.4 Pack and Ship the Equipment

- Carefully pack the system in original packing material to avoid shipping damage. Plainly show the RGA number on the outside of cartons as well as inside the carton along with the reason for return. Make a list of all components packed in the box. KEEP YOUR MANUAL.
- Return general repairs by any convenient method. Send priority repairs by air freight. Prepay the transportation charges FOB the repair site (either the Branson field office or Brookfield, Connecticut USA location).

NOTICE	
	Items that are sent Freight Collect will be refused.

1.6 Obtaining Replacement Parts

You can reach Branson Parts Store at the following telephone numbers:

- Direct Telephone Number: (203) 796-9807
- Fax number: (203) 926-2678

Many parts can be shipped the same day if ordered before 2:30 p.m., Eastern time.

A parts list is found in [Chapter 7: Maintenance](#) of this manual, listing descriptions and EDP part numbers. If you need replacement parts, coordinate the following with your purchasing agent:

- Purchase order number
- 'Ship to' information
- 'Bill to' information
- Shipping instructions (air freight, truck, etc.)
- Any special instructions (for example, "Hold at the airport and call"). Be sure to give a name and phone number
- Contact name information

Chapter 2: The Ultrasplice 40 Actuator

2.1	Model Covered	12
2.2	Overview of this Model	13
2.3	Features	16
2.4	Controls	17
2.5	Ultrasonic Theory	18
2.6	Terminology	24

2.1 Model Covered

This manual contains instructions for installing, setting up and operating the Ultrasplice 40 Actuator.

An Ultrasplice 40 Actuator requires a compatible Branson Metal Welding Controller to function, that is covered in separate manuals and user documents.

2.1.1 Controller Manual Set

The Following documentation is available for Branson Metal Welding Controllers that are compatible with Ultrasplice 40 Actuators:

- Ultrasplice 40 VersaGraphix Controller Instruction Manual (DCM00061)
- Ultrasplice 40 Touch Screen Controller Instruction Manual (DCM00002)

2.2 Overview of this Model

Figure 2.1 The Ultrasplice 40 Actuator



The Branson Ultrasplice 40 system is comprised of a power supply and control box, ultrasonic stack assembly, application tooling, and mechanical actuator. The Ultrasplice 40 actuator is the part of the system that rigidly holds and moves the converter, booster and horn assembly known as the ultrasonic stack. A pneumatic cylinder drives the anvil actuator to apply a precise pressure to the parts to be welded during the weld cycle.

The Ultrasplice 40 Actuator requires a compatible Branson Metal Welding Controller for power and control of the Actuator's operation and to provide ultrasonic power to the Converter in the Actuator.

The Ultrasplice 40 Actuator is designed with full, built in mechanical controls. Pneumatic control is done by a compatible Branson Metal Welding Controller.

Operation of the Ultrasplice 40 is controlled by inputs from a compatible Branson Metal Welding Controller.

2.2.1 Polar Mount & Ultrasonic Stack

The converter-booster-horn assembly or ultrasonic stack is supported in Polar mount by means of diaphragm springs. The diaphragm springs are mounted securely to the Polar Mount. The diaphragm shaped springs are made from titanium and are acoustically tuned at the 40 kHz operating frequency. This system permits very efficient transmission of ultrasonic vibration along the axis of the ultrasonic stack while providing an extremely rigid mounting.

The 40 kHz electrical energy from the power supply is applied to the transducer element or converter, which transforms the high frequency electric current into high frequency mechanical vibrations at the same frequency. The heart of the converter is a lead-zirconate-titanate electrostrictive element that, when subjected to an alternating voltage expands and contracts. The converter's efficiency of changing electrical energy to mechanical vibrations exceeds ninety-five percent.

2.2.2 The Pneumatic System

A pneumatic cylinder drives the anvil actuator to apply a precise pressure to the parts to be welded during the weld cycle. Pneumatic control is done by a compatible Branson Metal Welding Controller.

2.2.3 The Linear Encoder

The linear encoder is a sensing device that tracks mechanical displacements related to the splice's resulting height and/or width. The accuracy of the encoder is ± 0.002 in (± 0.05 mm).

2.2.4 Converter

The 40 kHz electrical energy from the power supply is applied to the transducer element or converter, which transforms the high frequency electric current into high frequency mechanical vibrations at the same frequency. The heart of the converter is a lead-zirconate-titanate electrostrictive element that, when subjected to an alternating voltage expands and contracts. The converter's efficiency of changing electrical energy to mechanical vibrations exceeds ninety-five percent.

2.2.5 Booster

A booster couples the converter to the horn and helps determine the amplitude of vibration produced at the face of the horn. The booster is a resonant half-wave metal device made of titanium or aluminum and is designed to resonate at the same frequency as the converter with which it is to be used.

A booster has two functions:

- A rigid mounting for the converter/booster/horn stack
- An amplitude-of-vibration increaser or decreaser as ultrasonic energy is transmitted from the converter through the booster to the horn. The ratio of input to output amplitude is called the gain.

2.2.6 Horn

The horn is a half-wave length resonant metal device that transfers the ultrasonic vibrations from the converter to the weld. The horn is made of tool steel and is designed to resonate at 40 kHz.

The horn is designed to grip the lower component of the parts to be welded, and to couple the ultrasonic vibrations through that element into the bonding area. Horns are fabricated from high-speed tool steel and heat-treated to precise specifications to provide maximum life. The horn is coated to further enhance tool life and to provide corrosion resistance.

Since the horn is a vital part of the ultrasonic assembly system, it should not be altered without proper training and advice from Branson.

2.2.7 Gathering Tool

A Gathering Tool sweeps across the face of the Tip to collect the wire strands and forms the width of the compression chamber.

Figure 2.2 Gather and Anvil

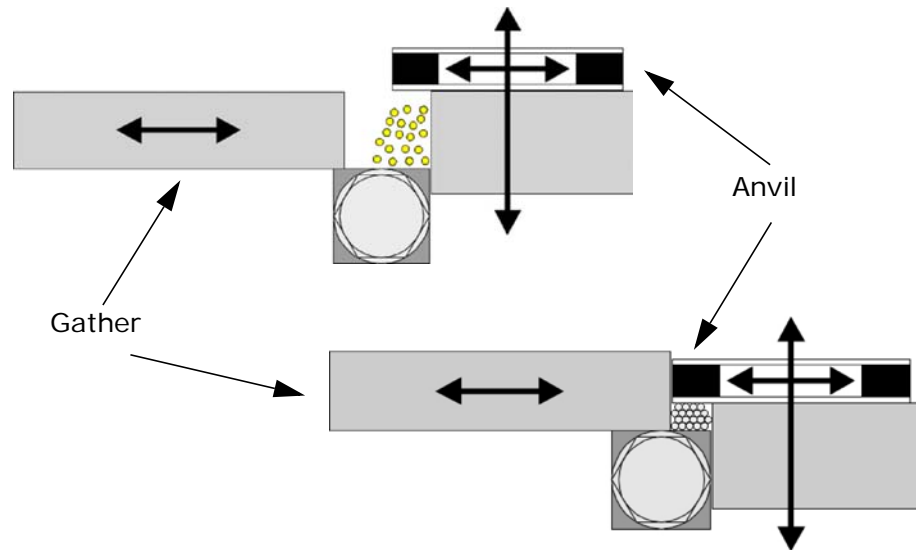

2.2.8 Anvil

The Anvil contains a serrated or knurled surface and is designed to hold the wires to be welded stationary against the lower component, which is vibrating at 40,000 Hz. The Anvil is supported on precision, roller bearings and applies the compressive force required to bond the wires.

2.2.9 Application Tooling

Application tooling is designed and manufactured to position and weld component materials to meet customer specifications. Application tooling typically consists of a tip, horn, anvil, tip guide block and gather block. The required knurl/serration pattern is generally determined by the weld application. The System Specification Sheet in the beginning of this manual lists tips and anvils that are commonly used.

Figure 2.3 Application Tooling

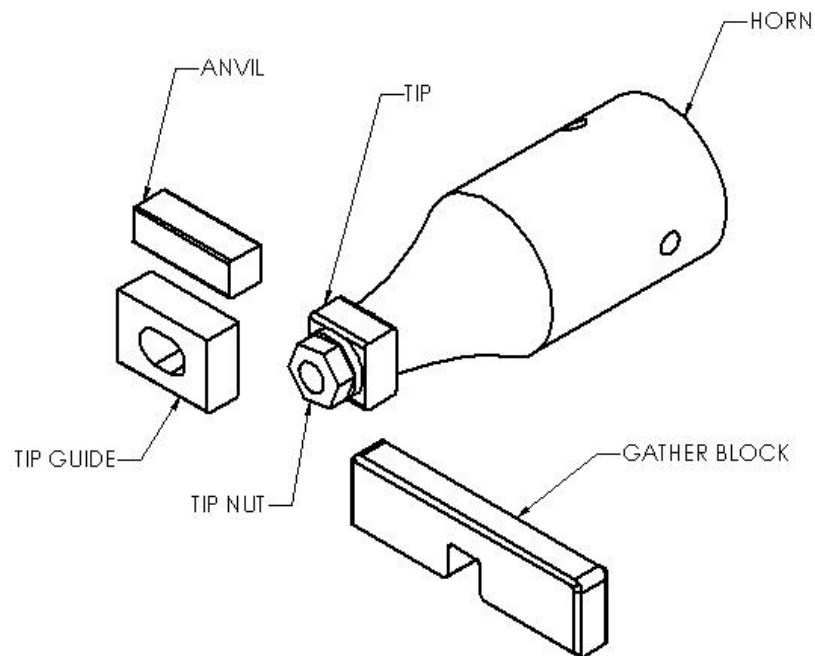

2.3 Features

The UltraSplice 40 is a complete 40 kHz, precision, light weight and portable, ultrasonic wire splicing system capable of producing perfect quality wire splices up to six square millimeters in cross section using an advanced 700 watt power supply.

The Ultrasplice 40 ultrasonic wire splicer offers the following features:

- Fully automatic wire gathering mechanism for ease of operation and maximum productivity
- Automatic process monitoring of each splice to ensure it falls within preset limits of weld time and weld power
- Infinite and automatic adjustment of splice energy and pressure
- Proprietary quick change tooling with multiple weld surfaces that can produce a million splices at minimum cost
- Simple procedure permits setup of various splice applications in under ten seconds
- User friendly control box with membrane switches and liquid crystal display
- Memory storage for 100 preset splicing parameters and sequences

2.4 Controls

- **Down Stop:** The down stop is used to prevent contact between the Horn and Anvil if the welder is cycled without the part(s) to be welded. A minimum gap of 0.001 in (0.02mm) is recommended
- **Gather adjusting screw:** Used to set the width of the compression chamber. Depending on the application the anvil will need to be set accordingly

2.5 Ultrasonic Theory

2.5.1 What Is an Ultrasonic Weld?

Ultrasonic welding joins metal parts by applying the energy of high frequency vibrations onto the interface area between the parts to be welded.

2.5.1.1 How Does It Work?

Electrical Energy is transformed into high frequency mechanical vibration. This mechanical vibration is transferred to a welding tip through an acoustically tuned horn. The parts are “scrubbed” together under pressure at 20,000, 40,000, or 60,000 cycles per second. This high frequency vibration, applied under force, disperses surface films and oxides, creating a clean, controlled, diffusion weld. As the atoms are combined between the parts to be welded, a true, metallurgical bond is produced.

Figure 2.4 How does Ultrasonic Welding Work?

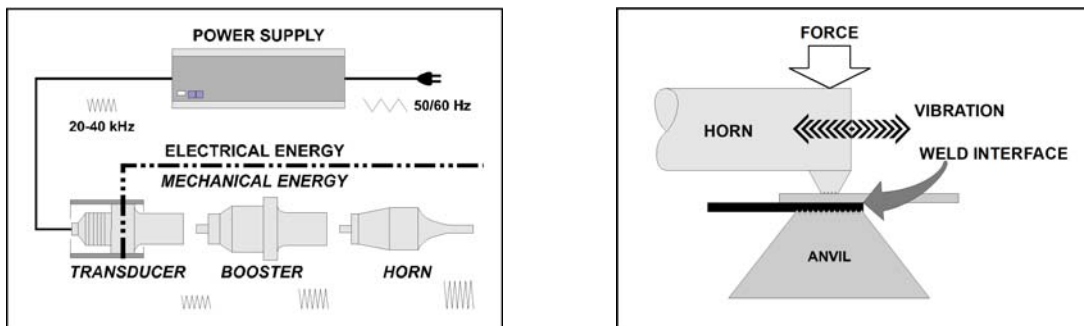

2.5.1.2 Benefits of Ultrasonic Welding

Ultrasonic metal welding exhibits unique welding properties that include:

- Excellent electrical, mechanical, and thermal connections between similar and dissimilar metals
- Low heat build up during the ultrasonic process (no annealing of materials)
- Compensation for normal surface variations of the material
- Ability to clean surface oxides and contaminants prior to welding
- Ability to weld large areas using minimal energy
- Ability to weld thin materials to thick materials
- Low cost per weld

2.5.2 How Is an Ultrasonic Weld Made?

Although the theoretical process of producing an ultrasonic weld is uncomplicated, the interactions of the various weld parameters are important and should be understood. When producing an ultrasonic weld, there are three primary variables that interact; they are:

- **Time:** The duration of applied ultrasonic vibration
- **Amplitude:** The longitudinal displacement of the vibration
- **Force:** The compressive force applied perpendicular (normal) to the direction of vibration

The power required to initiate and maintain vibration (motion) during the weld cycle can be defined as:

Table 2.1 Calculating Power

$P = F \times A \times f$	Where: <ul style="list-style-type: none"> • P = Power (watts) • F = Force * (N) • A = Amplitude (microns) • f = Frequency (Hertz)
*Note: Force = (Surface Area of the Cylinder) X (Air Pressure) X (Mechanical Advantage)	

Energy is calculated as;

Table 2.2 Calculating Energy

$E = P \times T$	Where: <ul style="list-style-type: none"> • E = Energy (joules) • P = Power (watts) • T = Time (seconds)
------------------------------------	---

Thus the complete 'Weld To Energy' process would be defined as:

$$E = (F \times A \times f) \times T$$

A well designed ultrasonic metal welding system will compensate for normal variations in the surface conditions of the metals by delivering the specified energy value. This is achieved by allowing Time (T) to adjust to suit the condition of the materials and deliver the desired energy.

2.5.3 Welding to Energy - Why?

Most metal welding applications are produced by 'Welding To Energy' in order to compensate for the various surface oxides and contaminants associated with the metals being joined. In a few applications 'Welding To Time' or 'Welding To Height' will yield better results. Since the majority of all metal welds are produced using energy as the controlling factor we will confine our discussion to that condition.

Welding to energy is necessary because of the non-metallic oxides that form on the metal's surface as well as other contaminants such as grease and dirt. To producing quality welds reliably it is necessary that the surfaces to be joined are clean. The high frequency scrubbing action, combined with pressure, cleans the weld interface at the beginning of the weld process.

The following graph ([Figure 2.5](#)) illustrates a weld produced. The weld 'power graph' is sometimes referred to a weld 'footprint'. It can be used to visualize the weld cycle and assists in parameter optimization. Graphs from consecutive welds will vary slightly as the system dynamically adjusts time to accommodate varying surface conditions. The weld power data is gathered by sampling the power used in 5 millisecond intervals.

Figure 2.5 Weld Power Graph for Clean Components, Dirty Components and when Part is Missing

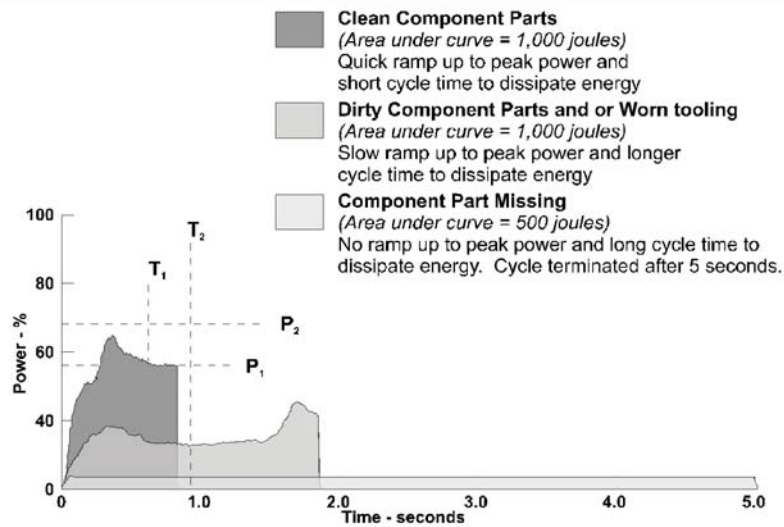

2.5.4 Power

The converter/ booster/ horn, (stack assembly), requires minimal electrical power to initiate and maintain motion (vibration) at a 'no-load' condition. As the mechanical load increases, the power required to maintain the mechanical vibration also increases. The maximum power required during a weld cycle is 'Peak Power'.

By increasing Pressure and maintaining all other parameters, the mechanical load or force on the weld joint increases, therefore, the amount of Power required to maintain the vibration of the stack increases. Subsequently, because of the increased Power Level, less time is required deliver the same amount of Energy. This relationship is illustrated on [Figure 2.6](#).

Figure 2.6 Pressure Variable with Increased Power

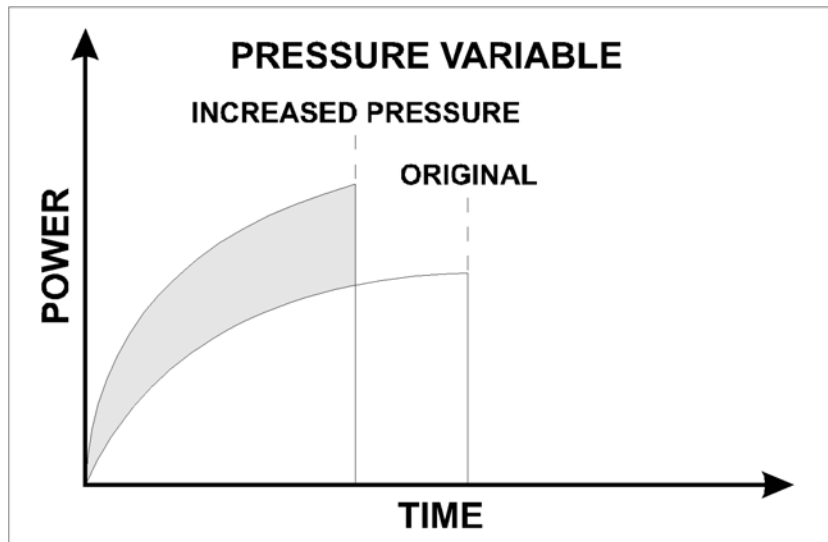

The difference in the appearance of each of the above weld graphs is the result of increased Power loading. Based upon an increase in Pressure, additional Power is required to maintain the motion of vibration. Thus, the same amount of energy is delivered in less time. This approach is typically used to raise the loading of the power supply during a weld cycle to the desired level as determined by the application.

2.5.5 Time

The time required to deliver the necessary energy is defined as the Weld Time. For most welds, the time required will be less than one second. If more energy is required and all other weld parameters are maintained, the weld time will increase ([Figure 2.7](#)).

Figure 2.7 Pressure Variable with Increased Time

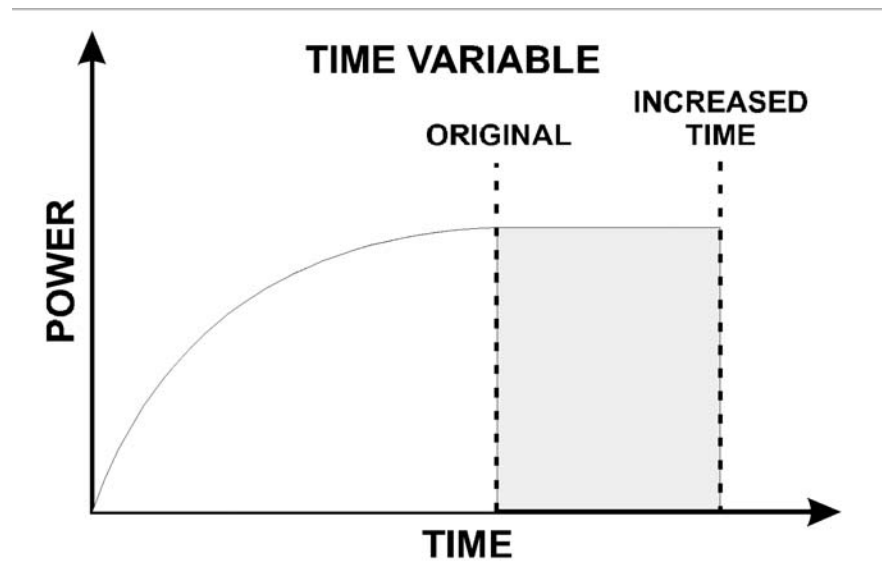

2.5.6 Amplitude

An ultrasonic tool is a resonant acoustical device. The term Amplitude is used to describe the amount of longitudinal expansion and contraction that the tooling endures as it vibrates ([Figure 2.8](#)). The amplitude correlates to the scrubbing action at the weld interface. This scrubbing action combined with pressure is what advances the weld by a diffusing or mixing of the base materials.

Figure 2.8 Scrubbing Action on Weld Interface

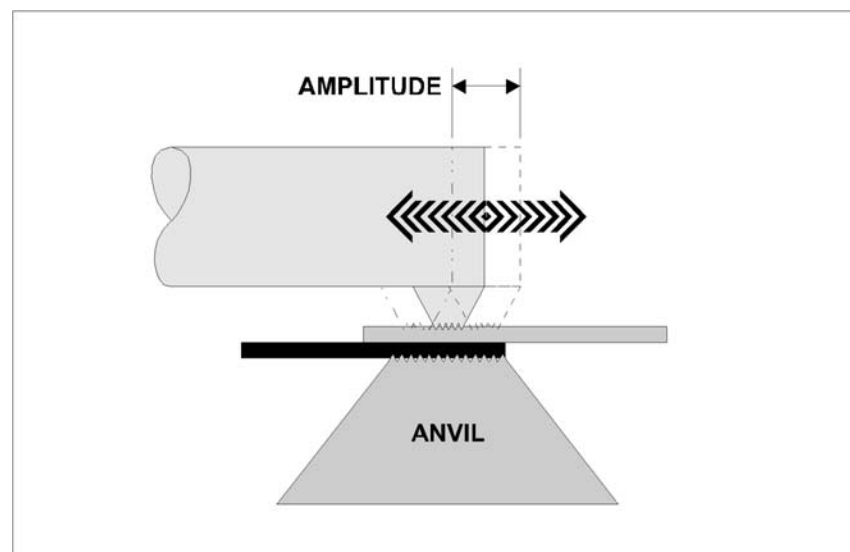

As previously mentioned, the converter/ booster/ horn, (stack assembly), requires minimal electrical power to initiate and maintain vibration in a 'no-load' condition. As the amplitude increases, the power required to maintain the increased velocity of vibration

also increases. Subsequently, because of the increased Power less time is required deliver the same amount of Energy. This relationship is illustrated in the following power diagram (Figure 2.9):

Figure 2.9 Amplitude's Influence on Weld Power and Time

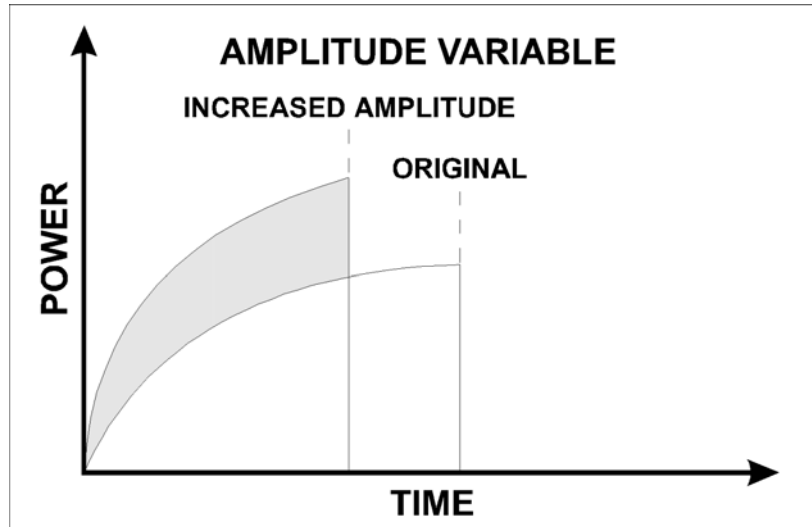

2.5.7 Resonant Frequency

The ultrasonic tooling acts as a spring having node points and anti-node points. The mechanical energy used to vibrate the tool is created by the converter. As the vibrations are propagated through the acoustical tool, a harmonic resonance is established consisting of nodes and antinodes. This action results in a resonant wave being transferred through the tooling (Figure 2.10). The efficiency of the resonant wave transfer depends on the natural resonant frequency of the horn and is determined by two factors:

- The speed of sound through the material
- The geometric shape of the object

Figure 2.10 Harmonic Resonance on Ultrasonic Tooling.

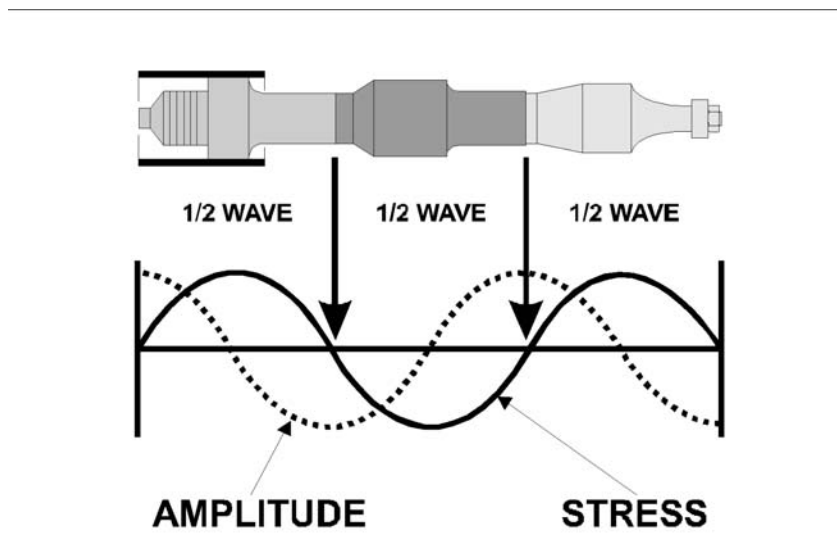

2.5.8 Avoiding an Overload Condition

It is possible to increase the Amplitude and or the Pressure to a point where the power available is not adequate to initiate or maintain vibration under the given mechanical load. At this point, the power supply will stall resulting in an Overload condition.

NOTICE	
	<p>Electronic circuits in the system will protect the power supply if an overload condition exists.</p>

2.5.9 Welding to Time

In specific applications, 'Welding To Time' may be desired. As previously mentioned, there are three primary variables that interact; they are:

- **TIME:** The duration of applied ultrasonic vibration
- **AMPLITUDE:** The longitudinal displacement of the vibration
- **FORCE:** The compressive force applied perpendicular (normal) to the direction of vibration

Generally, welding for a specific time will produce acceptable results when:

- The equipment is installed on an automated production line and each station must complete its process within a certain time limit
- Very small low energy welds on clean components are being made

2.5.10 Welding Temperature

Ultrasonic welding produces a localized temperature rise from the combined effects of elastic hysteresis, interfacial slip and plastic deformation. The weld interfaces reach approximately 1/3 the temperatures needed to melt the metals. Since the temperature does not reach the melting point of the material, the physical properties of the welded material are preserved. As the ultrasonic welding process is an exothermic reaction, as welding time increases so does weld temperature.

2.6 Terminology

Actuator: A mechanical device which houses the converter/booster/horn (stack) assembly in a rigid mounting and is utilized to move the stack up or down. This allows for precise control of welding pressure while delivering mechanical vibrations from the ultrasonic stack to the work piece(s).

After Burst: A short duration (burst) of ultrasonic energy that begins after completion of the AFTER BURST DELAY. (Also see AFTER BURST DELAY & AFTER BURST DURATION).

After Burst Delay: The amount of time, in seconds, between the completion of the ultrasonic welding cycle and the start of the AFTER BURST. (Also see AFTER BURST & AFTER BURST DURATION).

Amplitude: Amplitude is the peak-to-peak displacement of mechanical motion as measured at the face of the horn tip. Amplitude is measured either in thousandths of an inch or in microns (e.g. a standard 40 kHz *Converter* produces approximately 0.0004" or 10 microns of amplitude), Inches x 25.4 = microns. -- This is adjustable depending on system frequency and application tooling.

Anti-Node: The anti-node is the area of the horn and booster that exhibits maximum longitudinal displacement and where the internal dynamic forces are equal to zero. This area is at the face and back surface on half-wave technology.

Anvil: A device specially designed to grip the lower component and hold it stationary against the energy of vibration(s) which allows a weld to be created.

BBR: Nonvolatile random access memory (battery back-up random access memory). Equipped with long life built in batteries, this memory area preserves weld parameters and menu settings when the system is powered off. (Also known as BRAM.)

Booster: The central component of an ultrasonic stack assembly. A device which transfers mechanical energy from the *Converter* to the ultrasonic horn. The booster will, depending on design, increase, decrease, or maintain the specific amplitude as received from the converter.

Calibration: The process of adjusting a device to a known position for purposes of inspection and/or monitoring position, direction, speed, and/or velocity.

Consumable Spare Tooling: The tooling portion of the ultrasonic system that wears and requires replacement due to production use. This includes but is not limited to ultrasonic horns, replaceable tips, anvil, and positioning mask. A Spare Tooling Specification Sheet is included within the Actuator Operation Manual to document the spare tooling for a specific metal welding application.

Controller: The portion of the welding system that provides specific settings & instruction(s) to the overall welding system.

Converter: A device which utilizes a PZT (lead-zirconate-titanate) electrostrictive element to change high frequency electrical energy into high frequency mechanical energy.

Counter: A programmable device used to monitor system cycles and alert personnel when specific conditions are met.

Data: Any representation(s) of instructions, characters, information, or analog quantities to which meaning may be assigned.

Default: A chosen system setting or parameter in which the system does not require external data input. In some cases the default value will be changed based upon equipment use.

Dynamic Spring: An, adjustable, energy storage mechanism (shock absorber) which allows for stack follow through upon engagement of application tooling with the work pieces to be welded.

Energy: Energy is the area beneath the ultrasonic power curve and is calculated in joules, (Watts X Seconds = Joules). When the ultrasonic welding system is setup in the "Weld In Energy" mode the system will deliver the amount of energy as programmed. **NOTE:** The maximum (default) time allowed for delivering ultrasonic energy is five (5) seconds.

Energy Mode: A welding method in which the ultrasonic power supply is active until the required amount of energy is delivered (see ENERGY).

Fixture: A device for positioning and or holding a component for assembly.

Force: The amount of mechanical pressure that is used to deliver (bring down) the mechanical actuator. This programmed force is also called TRIGGER FORCE and is used to engage the knurl pattern into the component part(s) prior to the initiation of ultrasonic energy.

Frequency: The number of complete oscillations per second expressed in Hertz (Hz) or kilohertz (1 kilohertz = 1000 Hz). Typically 20 kHz or 40 kHz.

Gain: The ratio of the amplitude of motion produced by the *Converter* and delivered by the horn is called the gain. It is determined by the difference in mass on either side of the nodal point.

Height: A value, in millimeters (mm), as registered by a linear encoder upon completion of an ultrasonic welding cycle. -- Programmable, in millimeters, with Upper Control Limit & Lower Control Limit.

Height Encoder: A device utilized to monitor position, direction, speed, and/or velocity.

Horn: An acoustically designed metal tool that delivers mechanical energy from the converter/ booster into the work piece. Most applications utilize half wave technology.

Hold Time: The amount of time after delivery of ultrasonic energy until the stack tooling begins to retract from the component material(s).

Joint: The area where the surfaces are welded together.

Linear Height Encoder: See Height Encoder.

Loading Meter: A meter which indicates the power drawn from the ultrasonic power supply.

Maintenance Counter: Used to alert production personnel of the need to review/ inspect application tooling and/or the ultrasonic system for preventive maintenance purposes. (See Counters.)

Mode: The method of operating the system (also see WELDING MODE).

Node: The node is the area of the horn, (and booster), that exhibits no longitudinal displacement and where the internal dynamic forces are at the maximum. This area is in the center location on half-wave technology.

Parameter(s): Programmable units used to control and or monitor the ultrasonic process. --Include but not limited to ENERGY, FORCE, PRESSURE, AMPLITUDE.

Parts Counter: Used to monitor system cycles and alert personnel when specific conditions are met. (See Counters.)

Peak Power: Peak power is the maximum amount of power in watts that was required to keep the ultrasonic stack in motion during the weld cycle.

Power: Power, measured in watts, is a function of pressure and amplitude. The amount of power, (watts) required to keep the ultrasonic stack in motion is monitored and used to develop a power curve. This power curve is used to calculate the amount of energy delivered/ dissipated, (Watts = Joules / Time). The power as displayed on the control box is peak power.

Power Supply (Ultrasonic): An electronic device that converts 50/60 cycle electrical current into 20 kHz, (20,000), 40 kHz (40,000), or 60 kHz, (60,000) cycles per second high frequency electrical energy.

Power Supply Overload (Ultrasonic): The point or limit at which the amount of power in watts, required to keep the ultrasonic stack in motion, exceeds the available power from the power supply. The system will go into an overload condition in order to prevent system damage.

Pre-height: A pre-sonic inspection display, in millimeters (mm), as registered by a linear encoder prior to initiation of the ultrasonic welding cycle. -- Programmable, in millimeters, with Upper Control Limit & Lower Control Limit.

Presets: Welding parameters stored in the controller memory.

Pressure: The amount of mechanical pressure supplied to the ultrasonic stack assembly while delivering ultrasonic energy to the components.

Quality Widows & Limits: Programmable values used by the system to compare actual process data. Actual process data must be within limits or an alarm be issued.

Squeeze Time: The amount of time after the ultrasonic tooling engages the component(s) and before delivery of ultrasonic energy. -- Adjustable from 0 - 2seconds.

Stress: Stress is the amount of dynamic force per cross sectional area.

Time: Time is the duration of the ultrasonic, mechanical, activity. Time is a component used to calculate the amount of ultrasonic energy delivered during a weld cycle, (Time = Joules / Watts).

Tip: Device specially designed to grip the upper component, to be welded, and to direct the ultrasonic energy into the work piece, (Also Horn Tip & Replaceable Horn Tip).

Tip Nut: Device specially designed to securely clamp a replaceable tip onto the horn.

Trigger Force: See Force.

Tuning: Adjusting to optimize power supply performance according to resonance frequency, especially with regard to the horn and converter.

Velocity: The rate of motion at a specific time [velocity = distance time] Also referred to as speed.

Chapter 3: Shipping and Handling

3.1	Shipping and Handling	28
3.2	Receiving and Unpacking	29
3.3	Returning Equipment	30

3.1 Shipping and Handling

The Ultrasplice 40 actuator is a system of metal and electro-pneumatic components that move the ultrasonic tooling in the ultrasonic welding system and control aspects of the weld process. Many of its components can be harmed if the unit is dropped, shipped under improper conditions, or otherwise mishandled.

3.1.1 Environmental Specifications

The following environmental guidelines should be respected in the shipping of the Ultrasplice 40 Actuator unit.

Table 3.1 Environmental Requirements

Environment	Range
Storage / Shipping Temperature	-13°F to +131°F (-25°C to +55°C)
Humidity	30% to 90% non condensing

3.2 Receiving and Unpacking

Branson Metal Welding actuator units are carefully checked and packed before dispatch. It is recommended, however, that you follow the inspection procedure below after delivery.

To inspect the Ultrasplice 40 Actuator when it is delivered:

Table 3.2 Receiving and Unpacking

Step	Action
1	Verify that all parts are complete according to the packing slip.
2	Check the equipment immediately after delivery to ensure that it has not been damaged during transport.
3	Remove the actuator cover to check if any components became loose during shipping.
4	Report any damage claims to your carrier immediately.
5	Determine if any component has become loose during shipping and, if necessary, tighten screws.

NOTICE



If the goods delivered have been damaged during shipping, please contact the forwarding agent immediately. Retain packing material (for possible inspection or for sending back the unit).

CAUTION



The Controller is heavy. Handling, unpacking, and installation might require assistance of a colleague or the use of a lifting device.

3.3 Returning Equipment

If you are returning equipment to Branson, please call your Branson Metal Welding Representative or Customer Service to receive approval to return goods to Branson.

If you are returning equipment for repair refer to [Chapter 1: Safety and Support, 1.5 Returning Equipment for Repair](#) of this manual, for the appropriate procedure.

Chapter 4: Installation and Setup

4.1	About Installation.	32
4.2	Handling and Unpacking.	33
4.3	Take Inventory of Small Parts	34
4.4	Installation Requirements	35
4.5	Installation Steps	39
4.6	Safety Devices	41
4.7	Ultrasonic Stack Assembly	42
4.8	Testing the Installation	53
4.9	Still Need Help?	54

4.1 About Installation

This chapter is intended to help the installer with the basic installation and setup of your new Ultrasplice 40 system. This chapter will bring the reader to the point at which the system is functionally “ready to weld”.

CAUTION	
	The Controller is heavy. Handling, unpacking, and installation can require help or the use of lifting platforms or hoists.

International safety labels are found on the Controller and Actuator. Those that are of importance during installation of the system are identified in the figures in this and other chapters of the manuals.

4.2 Handling and Unpacking

If there are any visible signs of damage to the shipping containers or the product, or you later discover hidden damage, take pictures, and NOTIFY YOUR CARRIER IMMEDIATELY. Save the packing material.

1. Unpack the Ultrasplice 40 components as soon as they arrive. Refer to the following procedures.
2. Verify you have all of the equipment ordered. Some components are packed inside other boxes.
3. Inspect the controls, indicators, and surfaces for signs of damage.
4. Save all packing material. Evaluation systems will be returned using this material.

4.2.1 Unpack the Controller

Controllers are shipped in a cardboard carton. Controllers weight approximately 16 kg (36 lb).

1. Open the box, remove foam top packing half and lift the Controller out.
2. Remove the toolkit(s) and other components shipped with the Controller. These items may be shipped in small, separate boxes, or underneath the Controller in the box.
3. Save the packing material; evaluation systems will be returned using this packing material.

4.2.2 Unpack the Ultrasplice 40 Actuator

The actuator, is assembled and ready to install. The actuator weights approximately 3 kg (8 lb). Move the shipping container close to the intended installation location, leave it on the floor.

1. Open the top of the cardboard box, remove the insert from the top of the box and set it aside.
2. The toolkit, mounting bolts, and converter and/or booster are shipped with the actuator but in separate shipping box(es). Unpack the converter, booster, toolkit and bolts from their packages.
3. Save the packing material.

4.3 Take Inventory of Small Parts

Table 4.1 Standard small parts included with Controller and/or Actuator

Part or Kit	Description	Qty	Comments
211-127	40 kHz Torque Wrench	N/A	(Optional Item) Purchase Separately
X3A50252	Dial Indicator with Modified Magnetic Base	N/A	(Optional Item) Purchase Separately
201-118-024	Spanner Wrench	1	Toolkit
106-089A	Spanner Wrench, Modified	1	Toolkit
11008-09-001	Handle, Extension	1	Toolkit
211-099	Molykote GN Metal Paste	1	Toolkit
211-658	Set, Allen 1.5-5mm, Hex	1	Toolkit
211-636	Canvas Bag	1	Toolkit
M1A00137	Footswitch Assembly	N/A	(Optional Item) Purchase Separately

4.3.1 Cables

Two cables connect the Controller and Actuator: the analog data cable, and the RF cable. If the system is to be automated, you may also need a remote start cable. Check your invoice for cable types and cable lengths.

Table 4.2 List of Cables

EDP number	Description	Comments
101-240-179	RF, CE - 8' (J934C)	Standard
101-266R	Cable analog data, 10'	Standard

4.4 Installation Requirements

4.4.1 Location

The actuator may be installed in a variety of positions. The Ultrasplice 40 is often manually operated using a foot switch, and so it can be installed at a safe and comfortable workbench height (approximately 30-36 inches) with the operator sitting or standing in front of the system. The Controller may be located up to 8 feet away from the Ultrasplice 40 actuator.

The Controller must be accessible for user parameter changes and settings, and must be placed in a horizontal orientation. The Controller should be positioned so it does not draw in dust, dirt or material via its rear fans. Refer to the illustrations on the pages that follow for a dimensional drawing of each component.

4.4.2 Environmental Specifications

Table 4.3 Environmental Specifications

Environmental concern	Acceptable Range
Humidity	30% to 90%, (non-condensing)
Ambient Operating Temperature	+5°C to +50°C (41°F to 122°F)
Operating Altitude	1000 m (3280 ft)
IP Rating	2X

Figure 4.1 Controller Dimensional Drawing (VersaGraphiX)

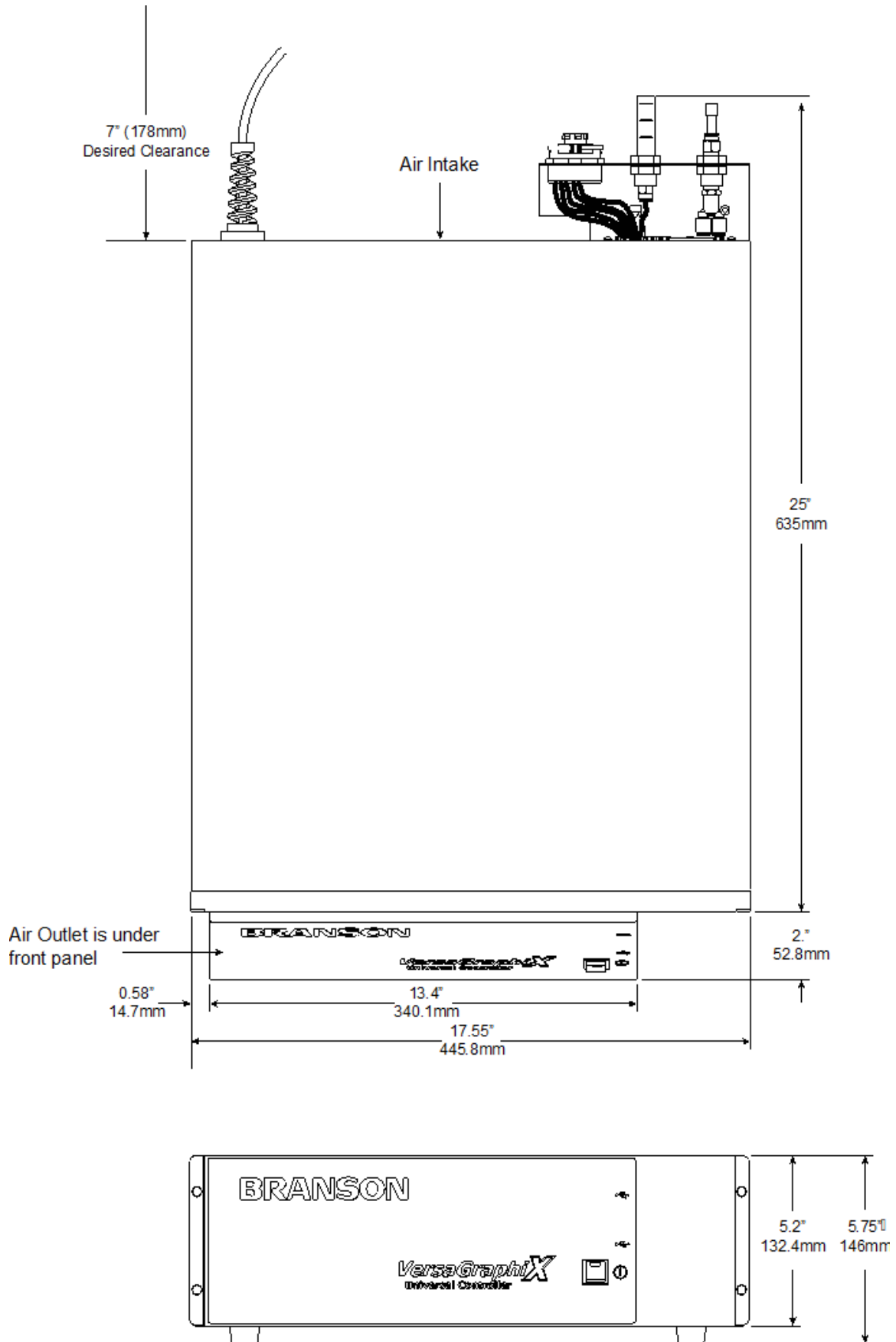
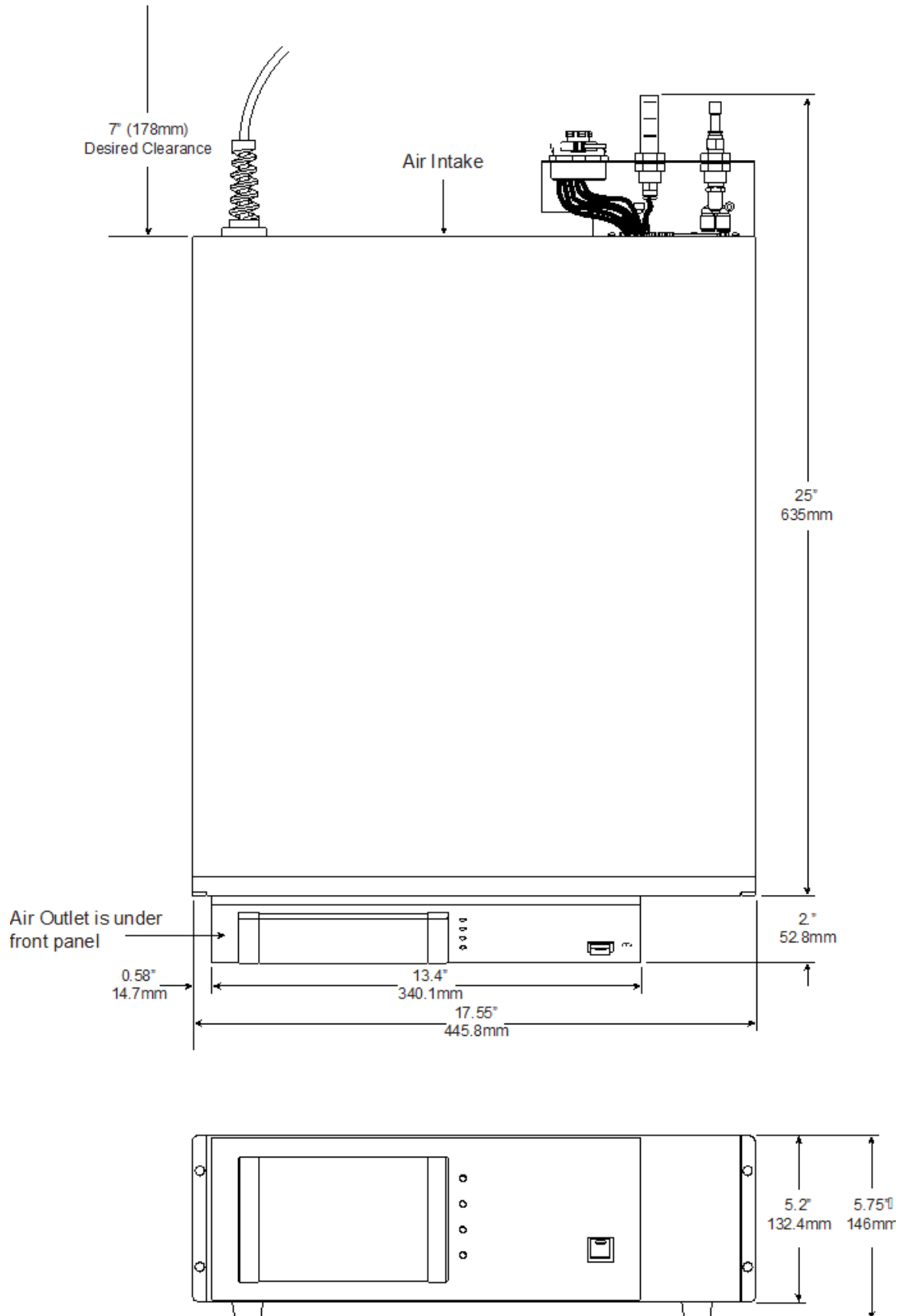

Figure 4.2 Controller Dimensional Drawing (Touch Screen)



4.4.3 Electrical Input Power Ratings

Plug the Controller into a single-phase, grounded, 3-wire, 50 or 60 Hz power source. [Table 4.4](#) lists the current and fuse ratings for the various models.

Table 4.4 Input Power requirements

Model	Power	Current Rating	NEMA Connector
40 KHz models	400 W 90V - 110V	10 Amp Max. @ 100V / 20 Amp fuse	NEMA 5-15P Plug
	800W 200V - 230V	6 Amp Max. @ 200V / 20 Amp fuse	NEMA L6-20P Plug

4.4.4 Factory Air

The factory compressed air supply must be “clean, dry and unlubricated” air with a regulated maximum pressure of 100 psig (690 kPa). Depending on your application, the actuator requires between 70 to 80 psi. Use a lockout device on the air line if required.

WARNING	
	<p>Synthetic air compressor lubricants containing Silicone or WD-40 will cause internal actuator damage and failure due to the solvents contained within these types of lubricants.</p>

4.4.4.1 Air Filter

Controllers for Ultrasplice 40 Actuators have an input air filter which protects from particulate matter of 5 microns or larger.

Polycarbonate bowls are suitable for use in normal industrial environments, but should not be located in areas where they could be subjected to direct sunlight, an impact blow, nor temperatures outside of the rated range: 40°F to 125°F (4°C to 52°C). As with most plastics, some chemicals can cause damage. Polycarbonate bowls and sight dome should not be exposed to chlorinated hydro-carbons, ketones, esters and certain alcohols. They should not be used in air systems where compressors are lubricated with fire-resistant fluids such as phosphate ester and di-ester types.

CAUTION	
	<p>TO CLEAN POLYCARBONATE BOWLS USE MILD SOAP AND WATER ONLY! DO NOT use cleansing agents such as acetone, benzene, carbon tetrachloride, gasoline, toluene, etc., which are damaging to this plastic.</p>

4.4.4.2 Pneumatic Connections to Actuator

Air connection to the Ultrasplice 40 actuator is made to the air line connector on the rear of the Controller using the UltraSplice 40 airline harness.

4.5 Installation Steps

4.5.1 Mounting the Controller

The Controller is designed to be placed on a workbench (rubber feet on bottom) within cable length limits of the actuator. It has two rear-mounted fans which draw cooling air from rear to front, which must be free from obstruction. Do not place the Controller on the floor or in other locations that will allow dust, dirt or contaminants to be drawn into the Controller.

The controls on the front of the Controller must be accessible and readable for setup changes (touchscreen models).

All electrical connections are made to the rear of the Controller, which should be positioned in your workspace with adequate clearance (approximately 4 inches or more on either side, and 7 inches to the rear) for cable access and ventilation. Do not place anything on top of the Controller case.

In the event the system is to be installed in a high dust environment, the use of a fan filter kit (101-063-614) is required.

See [Figure 4.1](#) and [Figure 4.2](#) for dimensional drawing of compatible Power Supplies.

Figure 4.3 Connections on Rear of a VersaGraphiX Controller

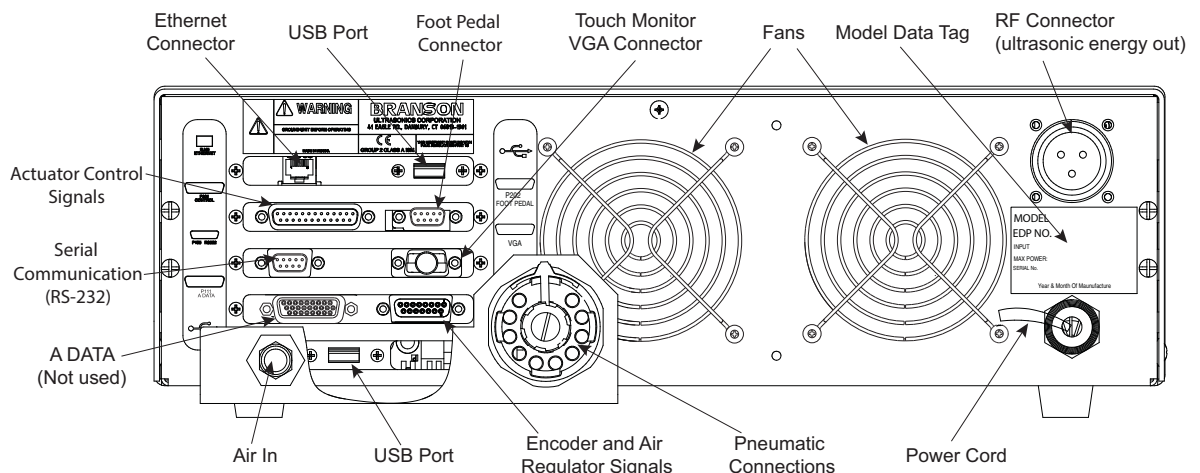
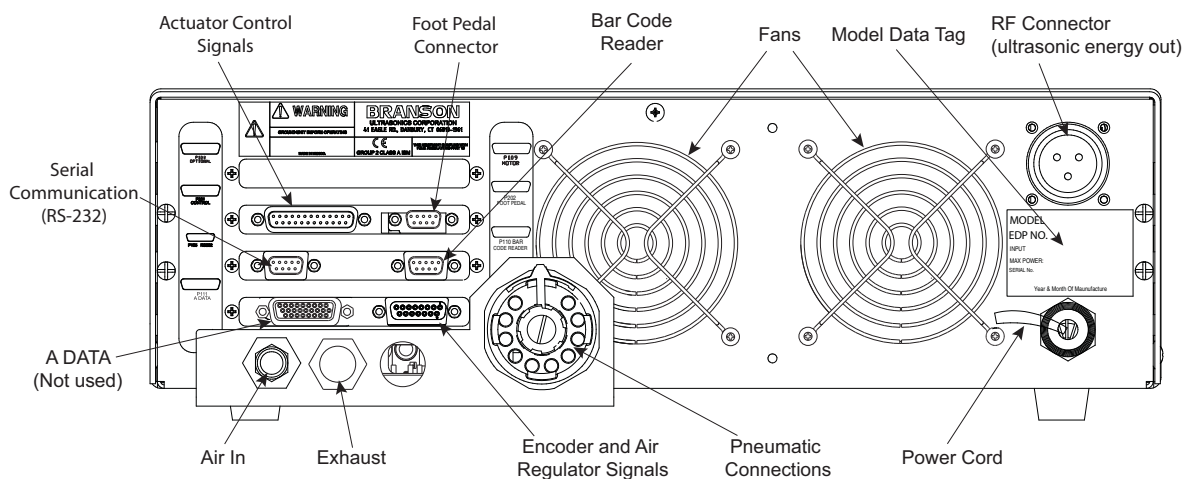

Figure 4.4 Connections on Rear of a Touch Screen Controller



The cable lengths are limited based on the operating frequency of the welding system. Performance and results can suffer if the RF cable is crushed, pinched, damaged or modified. Contact your Branson Representative if you have special cable requirements. In some cases, remote operation from a User I/O or a Remote Terminal can be used to solve a distance limitation.

4.5.2 Input Power (Main)

The system requires single-phase input power, which you connect to the Controller using the integral power cord. See [Table 4.4 Input Power requirements](#) for plug and receptacle requirements for your specific power level.

Refer to the unit's Model Data Tag to be sure of the power rating of the Model in your system.

4.5.3 Output Power (RF Cable)

Ultrasonic Energy is delivered to a screw-on MS receptacle connection on the rear of the Controller, which is connected to the Ultrasplice 40 Actuator.

WARNING	
	Never operate the System with the RF Cable disconnected or if the RF Cable is damaged.

4.5.4 Interconnect Between Controller and Actuator

The Ultrasplice 40 Actuator has two electrical connections between the Controller and the Actuator: the RF Cable, and the Analog Data Cable.

There can be other connections to the Actuator, and other connections to the Controller, but these are the two standard connections.

4.6 Safety Devices

The removal, bridging or disabling of safety devices is not condoned for production operation. Individual safety devices mentioned below may only be disabled if super-ordinate safety devices are employed in their place.

4.6.1 Emergency Stop

In case of danger, hit the red, emergency stop Which is found on the red, top portion of the foot pedal. The actuator, controller, and related fixtures are returned to the "Home" position. Twist the emergency stop to reset the system. If dual anti-tie start buttons are used, there must be a red emergency stop associated in line. Free access to the emergency stop button must be maintained.

4.6.2 Actuator Cover

The Ultrasplice 40 actuator is equipped with a cover which should only be removed for maintenance and installation purposes.

4.7 Ultrasonic Stack Assembly

Table 4.5 Ultrasonic Stack Assembly Procedure



Action	Reference
<ul style="list-style-type: none"> • Clean shell, booster and converter faces and diaphragm surfaces with solvent to remove all contaminants and previously used paste • Place shell on clean bench, either flat side down • Place front diaphragm (½" center hole) over shell face • Place end cap, over diaphragm • Align end cap and diaphragm with shell holes and assemble the socket head screws each in an alternating pattern • Repeat for rear diaphragm spring 	
<ul style="list-style-type: none"> • Apply and spread out an even coat of Molykote G-n paste (about equal to half a paper match head) to the booster face (the side with the stud) and the converter face. A very thin film of paste is all that is required. Do NOT apply paste to threaded opening, or to stud threads, or to diaphragm surfaces. Do NOT use silicone grease 	

Table 4.5 Ultrasonic Stack Assembly Procedure

Action	Reference
<ul style="list-style-type: none"> Place the assembled stack in a (optional) Benchtop stack mounting block Using a spanner wrench on the horn, tighten to 175 in-lbs. Tighten the converter to Booster to 150 in-lbs. 	
<ul style="list-style-type: none"> If the tip needs to be installed, put tip in position and thread on the Tip Nut <p>NOTICE Tip Nut has LEFT HAND THREADS (to prevent loosening during the weld cycle.)</p> <ul style="list-style-type: none"> Torque the tip to 125 in-lbs 	
<ul style="list-style-type: none"> Completed Stack Assembly 	

4.7.1 Installing the Stack in the Actuator

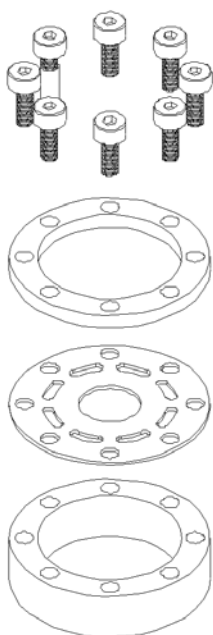
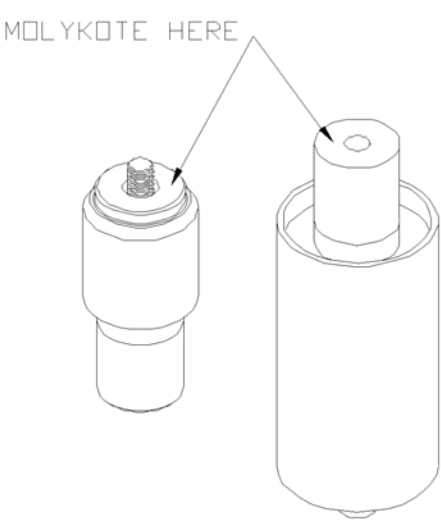
The ultrasonic stack must first be assembled. To install the stack: .

WARNING	
	<p>Make sure that the system power is turned off by disconnecting the power plug.</p>

Table 4.6 Mounting the Stack on the UltraSplice 40 Actuator

Action	Reference
<ul style="list-style-type: none"> Remove the top cover and horn cover 	
<ul style="list-style-type: none"> Remove the Support Brace 	

Table 4.6 Mounting the Stack on the UltraSplice 40 Actuator

Action	Reference
<ul style="list-style-type: none">Loosen the gather assembly retaining screws but do not removeSlide the gather assembly up and snug one screw to hold the gather assembly in its upper position	
<ul style="list-style-type: none">Remove the four stack hold down bolts.	

Table 4.6 Mounting the Stack on the UltraSplice 40 Actuator

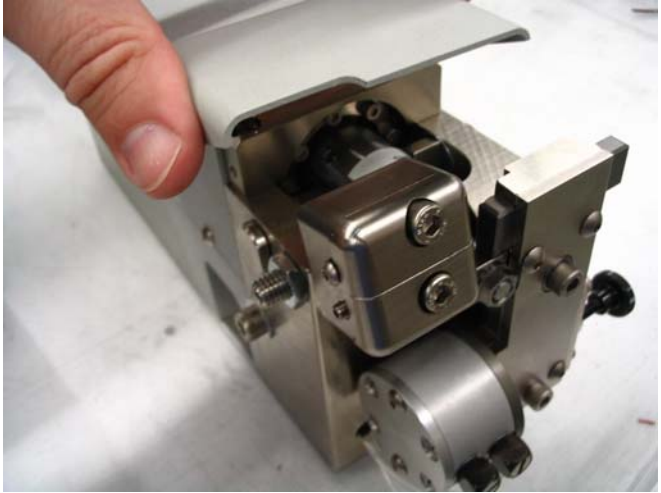
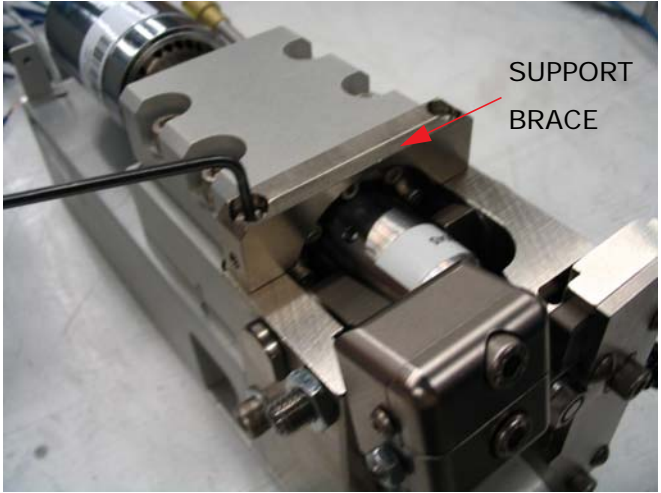

Action	Reference
<ul style="list-style-type: none"> • Place Stack into the actuator • Carefully bring the tip portion under the gather block • Install the following: <ul style="list-style-type: none"> -Stack Space Plate -Upper Stack Mount & -Upper Brace • Then tighten the side with Spacer and hand tighten other side 	
<ul style="list-style-type: none"> • With the Anvil Arm in the down position, slowly rotate the stack as the Tip Guide screw is turned in • When the stack can no longer rotate, proceed to the next step 	
<ul style="list-style-type: none"> • With Tip to Tip Guide Squared up, Loosen the Gather screws and manually press the Gather Block down onto the Tip • The hand tightened Stack mount screws can now be tightened securely. Be sure that all four Stack screws are tightened evenly 	

Table 4.6 Mounting the Stack on the UltraSplice 40 Actuator

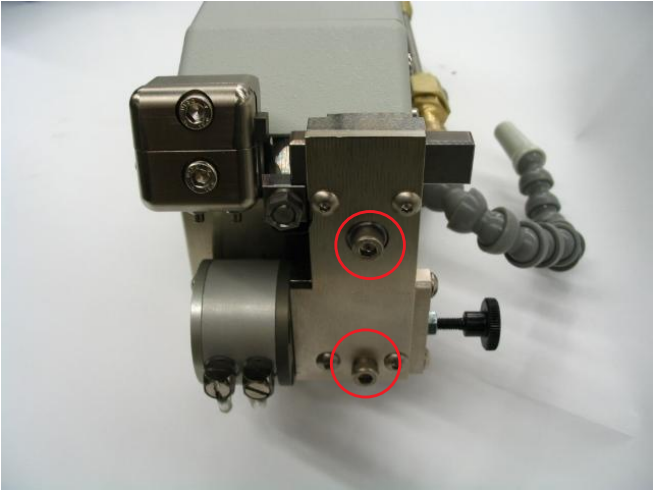
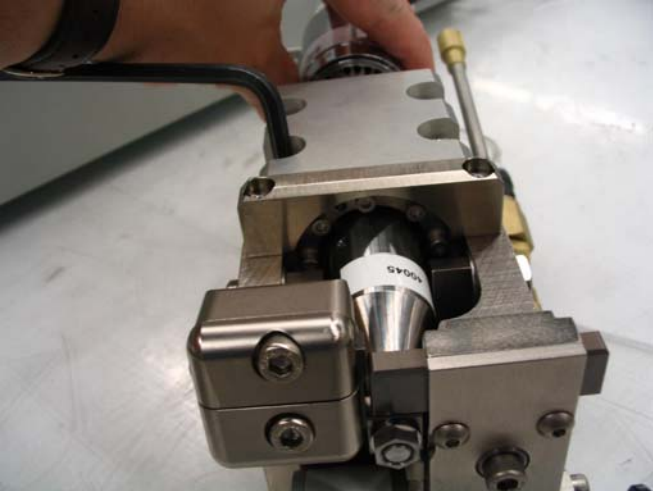
Action	Reference
<ul style="list-style-type: none">• Set tip guide gap by slightly loosening the Tip Glide clamp• Place a 0.001" Shim between the Tip and Tip Guide, as shown	
<ul style="list-style-type: none">• Loosen the Tip Guide lock nut and slowly bring in the set screw until a slight drag is obtained on the shim• Tighten lock nut and Tip Guide Clamp	

4.7.2 Down Stop Adjustment

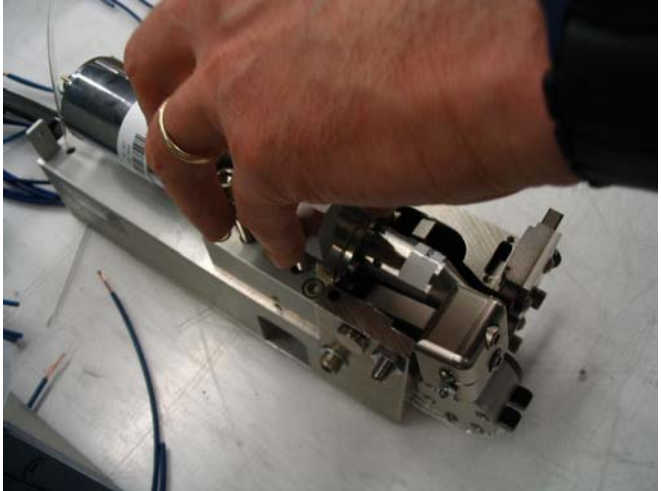
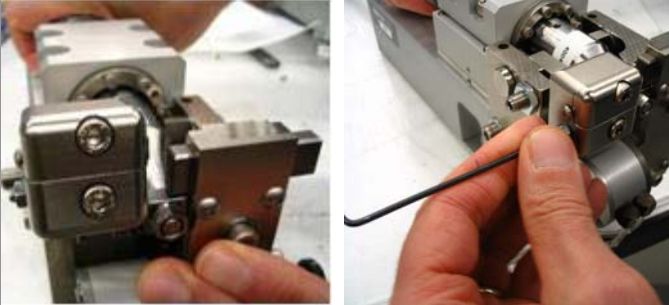
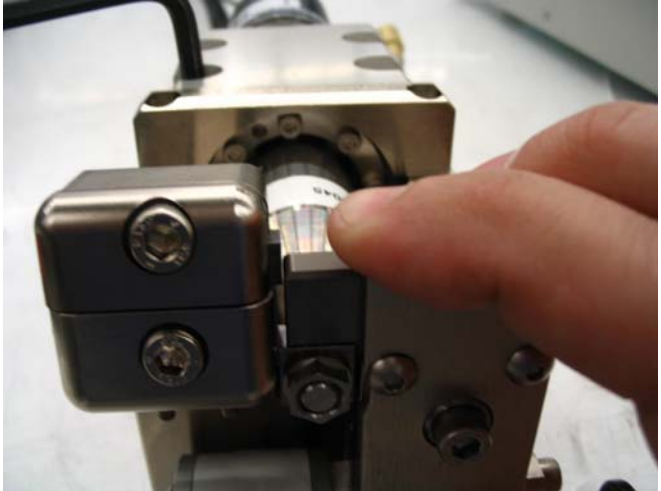
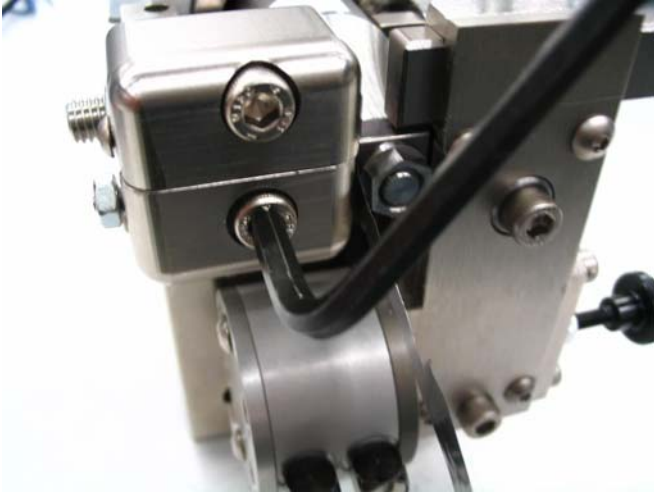
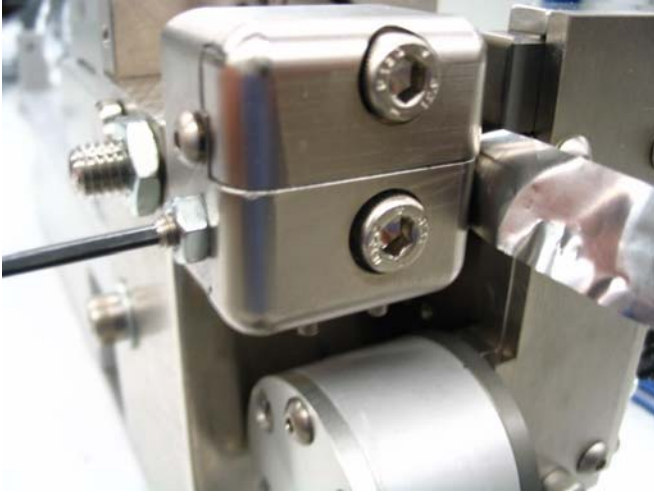
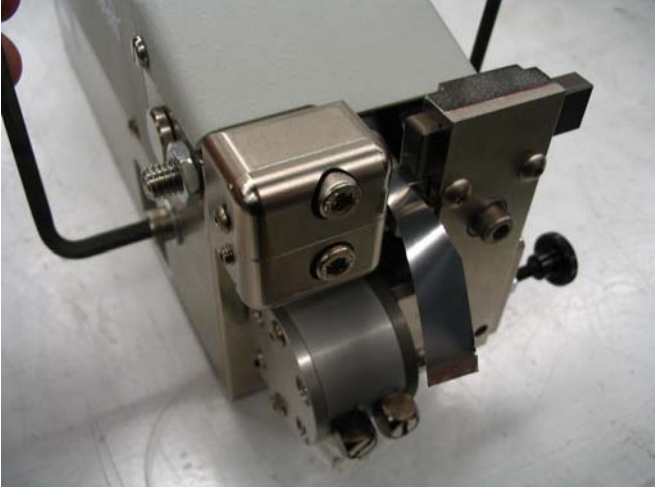
Table 4.7 Adjusting the Down Stop

Action	Reference
<ul style="list-style-type: none"> To adjust the anvil down stop, place a 0.001" to 0.002" shim between the tip and anvil as using a hex key wrench - turn the larger of the (2) socket head cap screws located on the side of the unit clockwise as needed This will rotate the eccentric down stop shaft within the actuator For best results, turn slowly until there is a slight drag on the shim 	
<ul style="list-style-type: none"> Set the Gather to Tip gap Start by loosening the (2) Gather Housing Socket head Cap Screws Place a 0.001" shim between the tip and bottom of the Gather Block. Let the anvil drop into the shim and tighten the (2) gather screws 	

4.7.3 Setting Anvil Width

Table 4.8 Setting Anvil Width

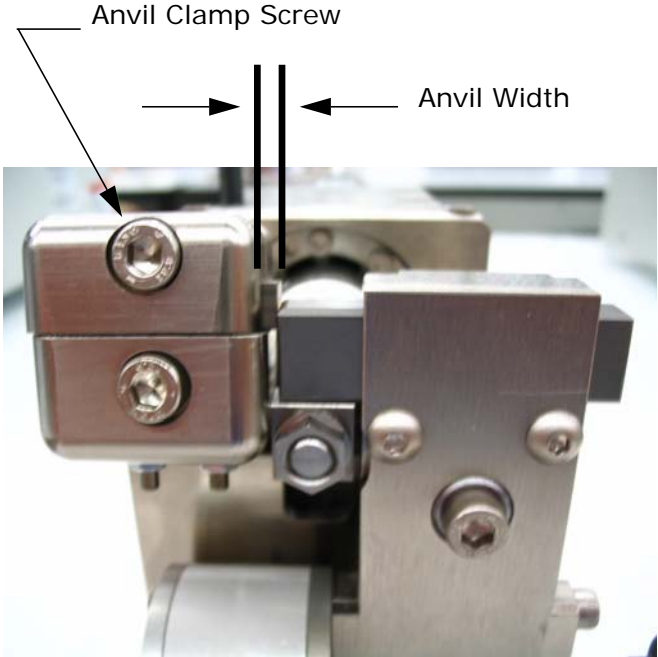
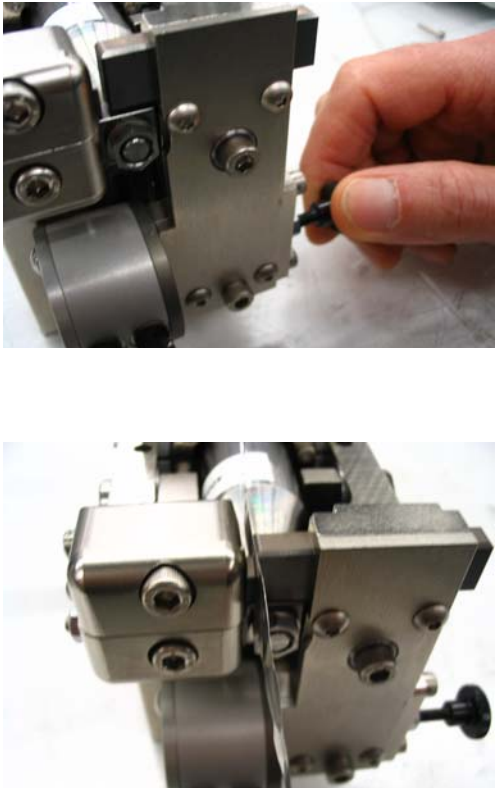
Action	Reference
<ul style="list-style-type: none"> Depending on the application, the anvil will need to be set accordingly Feeler Gages, Gage Pins and Drill Blanks are recommended for setting the required Anvil Width The anvil spring will drive the anvil out. Manually position the anvil where needed and Tighten the Anvil Clamp Screw 	 <p>The diagram shows a close-up of the anvil assembly. A vertical line indicates the 'Anvil Width' between two vertical surfaces. An arrow points to a screw on the left side labeled 'Anvil Clamp Screw'.</p>
<ul style="list-style-type: none"> Gather to Anvil Gap Place a 0.001" shim between the Anvil and side of the gather block Loosen the Gather adjusting Screw locknut With the Gather Adjusting Screw, bring in the Gather Block until a slight drag is obtained Then tighten the lock screw 	 <p>The top photograph shows a hand adjusting a screw on the side of the gather block. The bottom photograph shows the completed assembly with the gather block adjusted.</p>

4.7.4 Other Tooling Gaps

Table 4.9 Other Tooling Gaps



Action	Reference
<ul style="list-style-type: none"> If needed, the Anvil Arm support screw can be adjusted, as shown to set the Anvil to tip gap This is generally factory set 	 <p>Gather Adjusting Screw</p>
<ul style="list-style-type: none"> If the tip guide vertical adjustment is required. Loosen the Tip Clamp Screw and (2) Jack screw jam nuts Turn the (2) Jack screws until the Tip Guide is even with the bottom of the Anvil. For adjustment, only tighten enough to allow the anvil slide slightly Tighten the (2) Jam nuts and the Tip Guide Clamp screw 	
<ul style="list-style-type: none"> Re-install Top Cover and Horn Cover Reconnect R.F. cable 	

Table 4.9 Other Tooling Gaps

Action	Reference
<ul style="list-style-type: none"> Completed Assembly 	

4.7.5 Rotating Tip

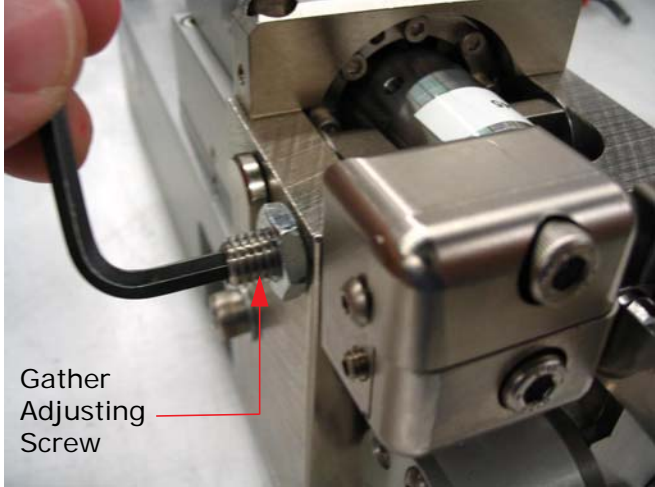
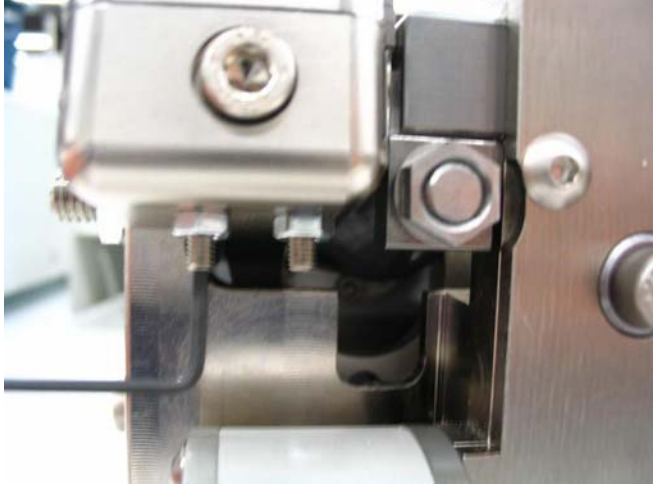
Table 4.10 Rotating Tip



Action	Reference
<ul style="list-style-type: none"> The Tip can also be rotated or replaced without removing the stack Remove the Tip Nut, Rotate the keyed Tip and re-install the Tip Nut <p>NOTICE LEFT HAND THREADS</p> <ul style="list-style-type: none"> Torque to 125 in-lbs 	

Table 4.10 Rotating Tip

Action	Reference
<ul style="list-style-type: none">• Completed Tooling Setup	

4.8 Testing the Installation

4.8.1 Check Splicer Performance

Ensure that nothing is touching the horn on all four sides. With the tooling disengaged and the welder unloaded, press the "SONICS" button on the Touchscreen controller for no longer than one second. If there is a loud squealing noise, the problem may be in the following areas:

- The Horn may be loose or not secured properly
- Tooling may be in contact with each other

4.9 Still Need Help?

Branson is pleased that you chose our product and we are here for you! If you need parts or technical assistance with your Ultrasplice 40 system, call your local Branson Metal Welding representative or contact the Branson customer service by calling the appropriate department as indicated in [1.5.3 Contact Information](#).

Chapter 5: Technical Specifications

5.1 Technical Specifications 56

5.1 Technical Specifications

5.1.1 Requirement Specifications

The Ultrasplice 40 actuator requires compressed air. The factory air source must be “clean and dry air”, that is, without moisture or lubricants. The Actuator requires 70 psi minimum pressure for operation and cooling, and can require up to 80 psi maximum, depending on the application. The following table lists environmental specifications for the ultrasonic welder. The following table lists environmental specifications for the ultrasonic welder.

Table 5.1 Environmental Specifications

Environment	Range
Humidity	30% to 90% non condensing
Ambient Operating Temperature	+5°C to +50°C (+41°F to +122°F)
Storage / Shipping Temperature	-25°C to +55°C (-13°F to +131°F)
Operating Altitude	1000 m (3280 ft)
Ip Rating	2X

All electrical input power connections are to the Controller.

5.1.2 Performance Specifications

The following table details some of the performance specifications associated with the Ultrasplice 40 Actuator.

Table 5.2 Ultrasplice 40 Actuator Performance Specifications

Maximum Welding Force (at 100 psi)	120 lbs of force
Height Encoder Accuracy	±0.05 mm
Maximum Splice Area	6 mm ²

Chapter 6: Operation

6.1	Actuator Controls	58
6.2	Initial Actuator Settings	59
6.3	Operating the Actuator	61
6.4	Safety Circuit Alarms	66

6.1 Actuator Controls

This section describes how to operate a weld cycle using the Ultrasplice 40 Actuator. For more detailed information on making and altering settings, refer to your Controller Manual.

CAUTION	
	Keep fingers away from the splicing nest when setting up and operating the Actuator. Down force (pressure) and ultrasonic vibrations can cause injury.

The Ultrasplice 40 Actuator is controlled by the Controller. Refer to your Controller manual for tuning testing, setup and operating instructions

6.2 Initial Actuator Settings

6.2.1 Weld parameters

To obtain quality welds each and every time, the correct combination of weld parameter settings must be developed. These parameters include:

- Energy (Joules)
- Weld Pressure, Pressure During Sonics (psi/bar)
- Amplitude (Microns)
- Splice Height to Width Ratio

6.2.2 Factory Air Source

Factory air must be turned on, supplying the Controller's air pressure regulator with air pressure. If factory air is too low (below 70 psi maintained) the actuator will not weld or operate reliably. Factory air is also used to provide cooling air to the converter.

Factory air input may affect weld results for applications requiring more weld pressure buildup.

NOTICE	
	<p>Factory Air pressure must be higher than the maximum system requirements. The compressed air system must have sufficient capacity to serve all of the systems connected to it. The use of an accumulator may be required to provide continuous air flow.</p>

6.2.3 Cooling Air

Cooling air is designed to keep the converter cooled to a reasonable temperature during welding.

6.2.4 Torque Check

Proper tightness of tooling is critical to assure efficient transmission of ultrasonic energy into the weld nugget. Please check the tightness of the following areas during a tool change or whenever looseness is suspected.

Table 6.1 Tooling Torque Check

Area	Suggested Torque
Horn to Booster	175 IN-LBS (19.8 N-M)
Converter to Booster	150 IN-LBS (16.9 N-M)
Tip Nut	125 IN-LBS (14.1 N-M) (Unless otherwise specified)

6.2.5 Emergency Stop

The emergency stop is found on the red, top portion of the foot pedal. When engaged it will prevent the actuator from running, and will also immediately terminate a weld cycle and cause the actuator to return to its "Home" position. It does not remove power from the system. The Controller will indicate that the system is in emergency stop mode and emit a beep sound when the emergency stop is engaged. Twist the emergency stop to reset the system.

6.3 Operating the Actuator

For detailed information about Ultrasplice 40 Actuator controls, refer to [2.4 Controls](#).

6.3.1 Check Welder Performance

Ensure that nothing is touching the horn on all four sides. With the tooling disengaged and the welder unloaded, press the “SONICS” button on the Touchscreen controller for no longer than one second. If there is a loud squealing noise, the problem may be in the following areas:

- The Horn may be loose or not secured properly
- Tooling may be in contact with each other

NOTICE	
	<p>For information on locating the “SONICS” button on your particular Controller model please refer to your Controller manual.</p>

6.3.2 Developing a Splice

Now that you have your new UltraSplice 40 ultrasonic wire splicer set up and ready to run let's review a process to optimize the splice. This is a step by step process including suggestions and photographs of actual wire splices. The photographs illustrate the progression of poor splices from under welded to over welded ending with a representation of the perfect splice that will give excellent process capability (Cpk) values when destructively tested. Guidance is also provided for the proper procedure for destructive testing.

Place the wires into the target area of the splicer. Refer to [Figure 6.1](#). It is recommended that larger wires be closest to the welding tip when there is a significant difference in wire sizes being spliced. The reason for this is that the larger wire takes more energy to weld each of its strands to its neighbor. If we tried to do this through the smaller wire there is a possibility the smaller wire could be damaged or overwelded before the larger wire was welded. It is also recommended that wires be placed on top of one another as much as possible to ensure good welding from wire to wire and to avoid the possibility of a “side splice”.

Activate the splicer and make a splice.

Examine the splice. Refer to [Table 6.2 Wire Splice Comparison](#) Based upon your observation make adjustments as follows:

If you see loose strands (Ref. C) increase the welding pressure in 10% increments as you make additional splices. If, after increasing the welding pressure by 20% there are still loose strands increase the amplitude by 10%. Continue to follow this sequence until the splice looks good with no loose or broken strands. (Ref. H)

If you see broken strands or flash (Ref. D) reduce the amplitude by 10% and make a splice. If the splice is still overwelded, reduce the welding energy by 10% and make another splice. If the splice is still overwelded, reduce the welding pressure by another

10%. Continue to follow this sequence until the splice looks good with no broken strands or flash.

Once you have achieved a splice that appears good by following step 4 above, it is time to do some destructive testing. Pull test the splice according to recommended pull test technique. Fixturing of the splice for tensile testing is very important. Care must be taken to ensure no twisting of the nugget occurs. Testing should be on the smallest diameter wire and/or the wire closest to the anvil. The reason for this is that the anvil side of the nugget has received the least amount of ultrasonic energy and should be the weakest part. If this wire meets the tensile strength specification then it is safe to assume the splice is good. Wherever possible, it is a good idea to use multiple wires to anchor the test specimen and ensure an even pull on the wire being tested. If the splice meets specifications for strength make a minimum of 10 splices, pull test them and calculate the Cpk. If the Cpk is not satisfactory, examine the splice carefully to determine how it is failing. An underwelded splice will fail by separating at the weld. An overwelded splice will fail at the transition point of welded to unwelded wire. Based upon your observation return to step 4 and repeat the optimization process. Note that the best splices will fail at the transition but will do so at a consistent and predictable force. It is therefore necessary to pick weld parameters that meet this condition without excessive deformation of the wire strands.

Figure 6.1 Proper Wire Insertion

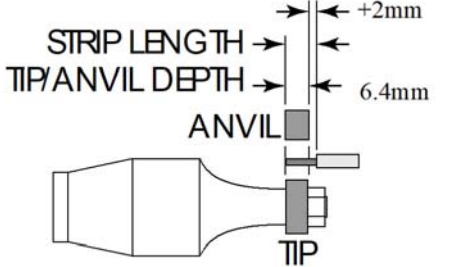
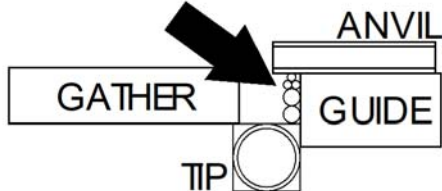
<p>STRIP LENGTH</p>		<p>Wires should be stripped to a dimension 2 mm longer than the Tip/Anvil depth.</p>
<p>PLACEMENT IN WELDING ZONE</p>		<p>Care should be taken to stack the wires vertically wherever possible to ensure an optimum splice.</p>

6.3.3 Evaluation of Splice

How to evaluate an ultrasonic splice is one of the first questions to be answered. A splice must withstand vibration, moisture, high current loads, heat, and cold. Extensive studies have shown that the ability to meet these requirements is directly related to the pull strength of the wire splice.

Peel strength is, of course, important. A minimum level of resistance to peel must be associated with each splice to allow handling of wire harnesses during manufacturing and installation without an adverse effect on the splice. However peel strength does not relate directly to the ability to pass the aforementioned requirements. In fact, such things as placement of the wire in the splice affect peel strength and the degree of extrusion experienced during welding. Indeed, over-welding or extruding a wire splice will increase

peel strength while decreasing the pull strength and therefore the ability of the splice to perform satisfactory.

Table 6.2 Wire Splice Comparison







Ref	Photo of Condition	Schematic	Description
A			<p>WIRE OVERLAP - Damaged or burnt insulation</p>
B			<p>OVER WELDED - Wire not fully inserted into weld pocket</p>
C			<p>UNDER WELDED - Pressure too low</p>
D			<p>OVER WELDED - Pressure and amplitude too high (flash & burning)</p>
E			<p>FLASH - Tip guide gap too big</p>

Table 6.2 Wire Splice Comparison

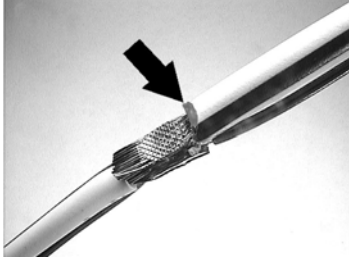
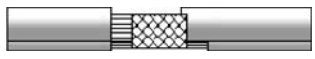
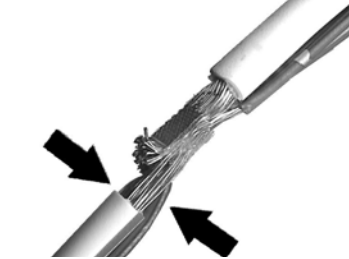
Ref	Photo of Condition	Schematic	Description
F			FLASH - Gather gap too big
G			SIDE SPLICE - Incorrect wire stacking in weld pocket
H			GOOD SPLICE

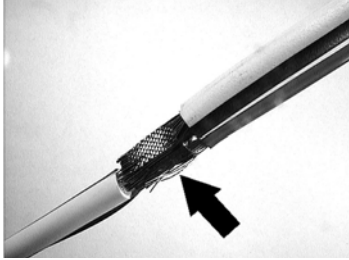
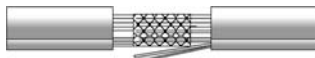
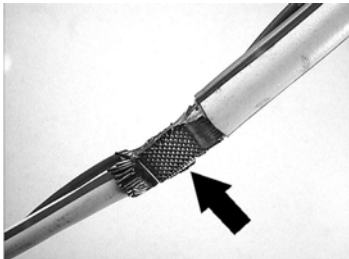
6.3.4 Spliced Wire Pull-Testing

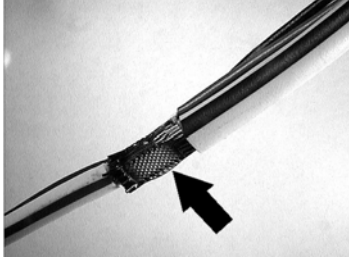
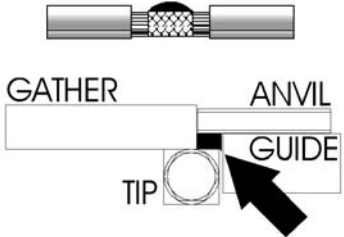
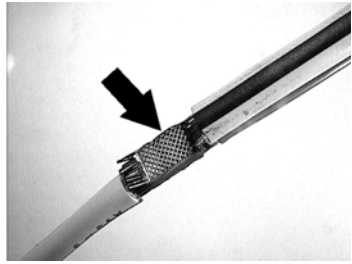
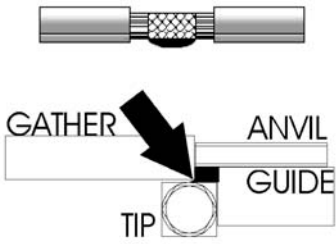
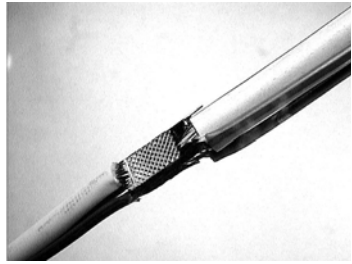
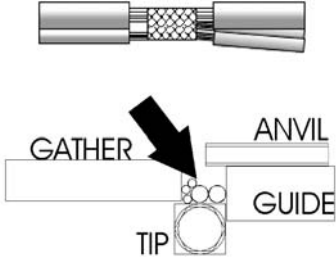
The weakest wire in tension of any splice is the wire with the smallest cross sectional area or gage. When all the wires in a splice are the same gage, the weakest wire in tension of any wire splice is the wire closest to the anvil. This is true since sonic vibration (amplitude) and energy begin at the horn tip and travel through the splice to the stationary (zero amplitude) anvil. Therefore, by pulling either the wire welded on the anvil side or the smallest gage wire, the operator will ensure that the machinery is transmitting a sufficient level of energy to achieve a quality splice.

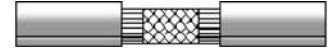
The pull test value must meet the required value established by your customer for the smallest gage wire in the splice. In addition, the following conditions have always been cause for rejection:

- Broken strands
- One or more loose strands
- Excessively burnt insulation
- Excessively frayed ends
- Failed torsion (twist) test

6.3.5 Quality Monitoring

The Ultrasplice System is capable of monitoring two welding variables during each cycle; weld time (secs) and peak weld power (watts). Each variable can be set with upper and

lower limits. When a limit or limits are violated, an audible alarm sounds. The type of alarm and associated value are displayed on the controller.

The setting of upper and lower quality limits is the responsibility of the end user. It is recommended that these limits be calculated using statistical methods.

6.3.6 Compaction vs. Tensile Strength

Knowing that pull strength (tensile strength) directly relates to the ability of the splice to meet performance criteria the question becomes, "How do I maximize tensile strength?" Studies at Branson on a range of wires in a 2 X 2 splice configuration clearly show that maximum tensile strength is achieved when the wires are welded and compacted to a dimension which is 20% greater than their solid copper cross section, (refer to Percent Compaction versus Tensile Strength graph, [Figure 6.2](#)).

Figure 6.2 Percent Compaction vs Tensile Strength

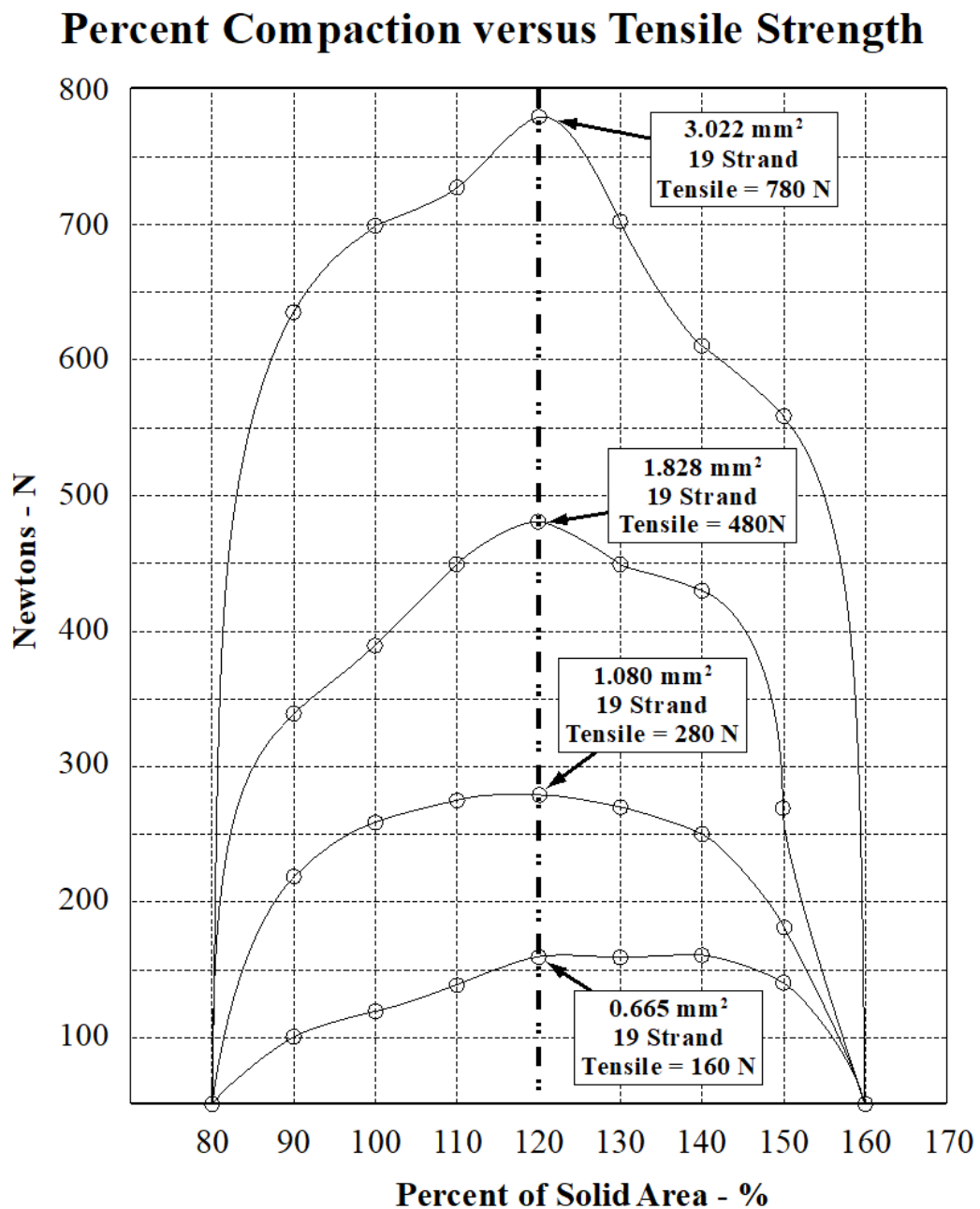

6.4 Safety Circuit Alarms

The Safety Control System within the Controller constantly monitors the system's safety related components for correct operation. When this system detects a fault condition, operation is interrupted and the system immediately goes to a safe state. A beeper is used to signal a safety system alarm.

Use the following procedure to troubleshoot safety circuit alarms:

1. Verify that the 9-pin footswitch cable is properly connected to the back of the Controller.
2. Power down and then power up the Controller to reset the system.
3. If the alarm persists, call Branson Support. See [1.5.3 Contact Information](#).

Chapter 7: Maintenance

7.1	Periodic and Preventive Maintenance	68
7.2	Calibration	76
7.3	Troubleshooting	79
7.4	Parts Lists.	83

7.1 Periodic and Preventive Maintenance

7.1.1 Maintenance Safety

Safety devices, especially covers, guards and ground cables should only be removed when it is absolutely essential for the completion of maintenance work. If safety devices were removed prior to starting maintenance work, be sure to re-install those devices after finishing the maintenance work. The following installation and maintenance operations must be performed prior to any disassembly of equipment:

WARNING	
	<ul style="list-style-type: none"> • All system components must be disconnected from the main electrical supply • Use LOTO (Lock Out Tag Out) lockable plug cover over line cord plug during any maintenance • Disconnect the air hose from the main air supply

7.1.2 Periodic Maintenance

In order to maintain optimum operating conditions, it is important to perform various maintenance and equipment inspections at periodic intervals. Please observe the following recommendations.

7.1.2.1 Daily Maintenance:

- Drain water and contaminants from the airline filters, if required

7.1.2.2 On Every Tool Rotation

- Inspect the clamping surfaces of the Tip, the Tip Nut and the Horn for fretting
- Vacuum and clean out any copper residue or dirt in the actuator

7.1.2.3 Filter/Filter/Regulator – Disassembly

Air Filter/Filter/Regulator (Optional component, Branson part# 207-020) should be serviced after 1 year or when a pressure drop of 15 psi is reached.

- Disconnect the air supply
- Relieve the air pressure in the FFR assembly by depressing the white button on bottom of the first filter until all air has been exhausted
- Pull down black button on first filter housing, rotate housing 1/8 turn until two marks line up and then pull housing down
- Clean out housing with a clean rag

CAUTION	
	DO NOT USE SOLVENT.

- Unscrew brass-colored filter element and the black water separator/nut combination

- Replace brass-colored filter element number 5 and reassemble in reverse order
- Remove housing on second filter in the same way in which the first housing was removed

CAUTION	
	DO NOT USE SOLVENT.

- UNSCREW WHITE FILTER ASSEMBLY AND DISCARD

NOTICE	
	The brass-colored filter element in the first assembly may be cleaned in solvent, dried and re-used, if necessary. The white filter element in the second assembly cannot be cleaned and must be replaced. Clogged filters will reduce the performance of equipment.

- Replace the white filter and re-assemble in the opposite order
- Reconnect air supply
- Turn air valve to the position marked "sup."

7.1.3 Recondition the Stack (Converter, Booster, and Horn)

The transmission of ultrasonic energy along the stack (converter/booster/horn) requires a tight and clean interface between the components.

Please remove the stack and check the interfaces once every three months or whenever a problem is suspected.

7.1.3.1 Ultrasonic Stack Disassembly

WARNING	
	Be sure that the Controller is off to prevent any possible electrical shock from the high voltage contact on the converter.

Figure 7.1 Exploded Ultrasonic Stack Assembly

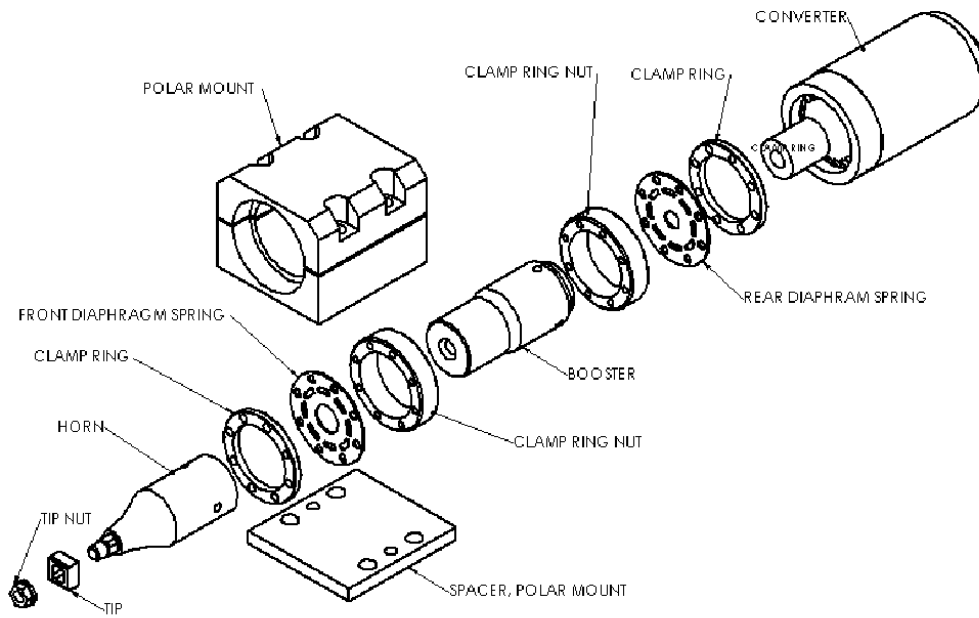

Table 7.1 Stack Removal Procedure

Action	Reference
<ul style="list-style-type: none"> • Disconnect the R.F. cable from the converter and the system air supply from the back of the touchscreen controller • Remove the top cover and horn cover 	
<ul style="list-style-type: none"> • Remove the Support Brace 	

Table 7.1 Stack Removal Procedure

Action	Reference
<ul style="list-style-type: none"> Loosen the gather assembly retaining screws but do not remove Slide the gather assembly up and snug one screw to hold the gather assembly in its upper position 	
<ul style="list-style-type: none"> Remove the four stack hold down bolts 	
<ul style="list-style-type: none"> Carefully lift the stack out by raising the converter and then sliding the stack back to free the tip of the horn from the tool block 	

Table 7.1 Stack Removal Procedure

Action	Reference
<ul style="list-style-type: none"> • With the Stack removed, place it in the optional stack mount block [H4A50011] to remove the horn • Using a spanner wrench, turn the horn counter-clockwise and spin horn off 	

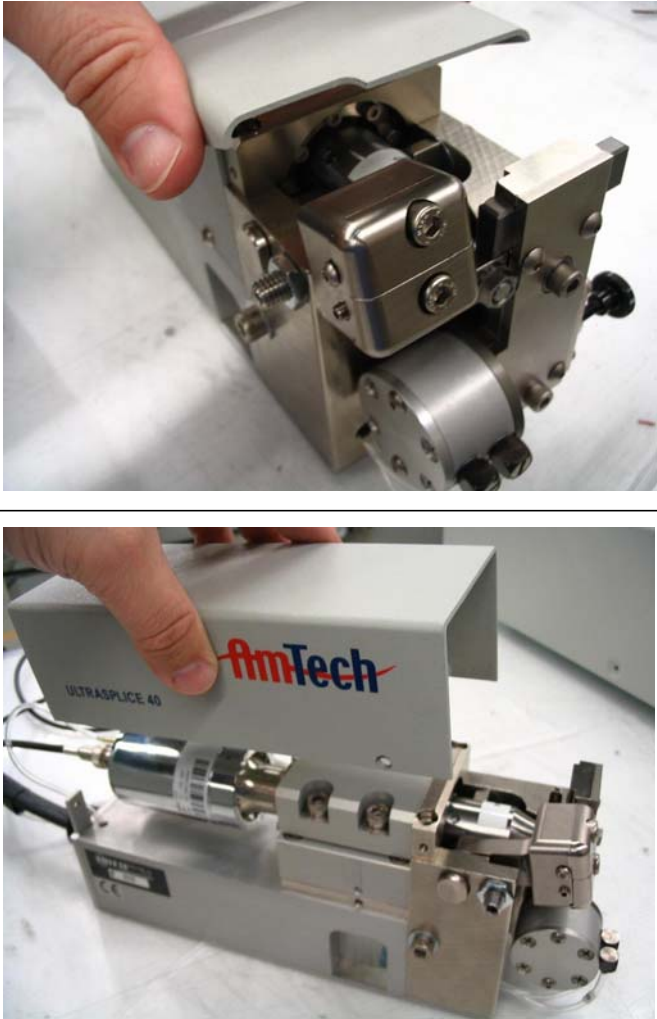
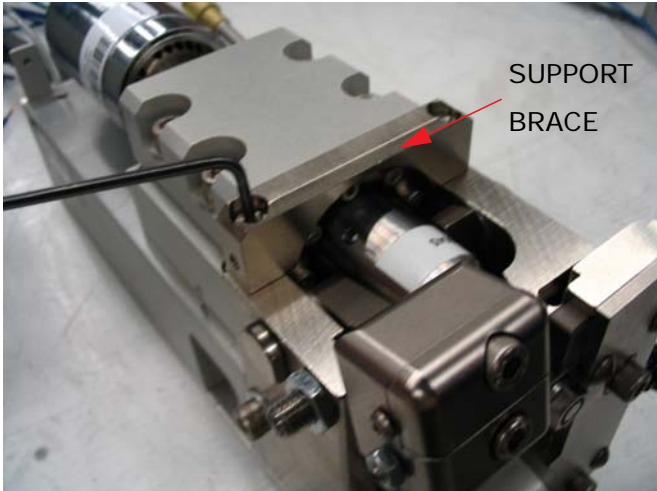
Table 7.2 Disassembly of the Ultrasonic Stack

Action	Reference
<ul style="list-style-type: none"> • Remove stack from the mount block • Using the applicable hex wrench, remove the screws that retain the front and rear diaphragm springs 	
<ul style="list-style-type: none"> • Clean, and polish away any roughness on the diaphragm springs or on the clamping faces of the booster 	

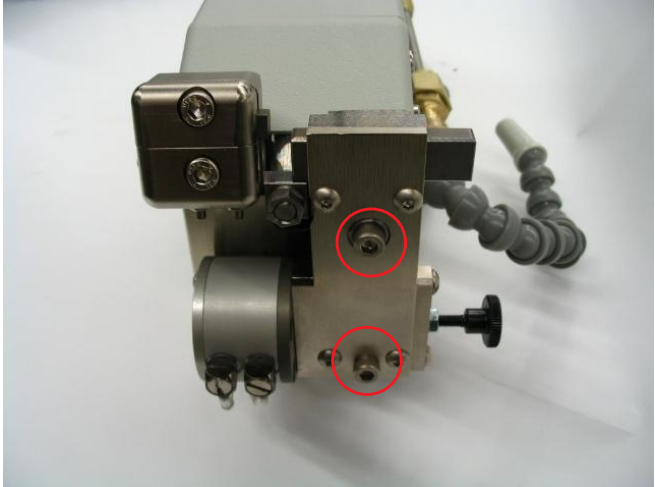
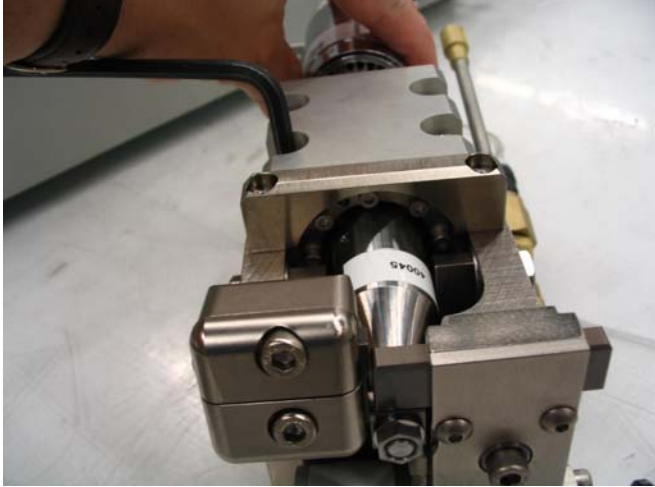
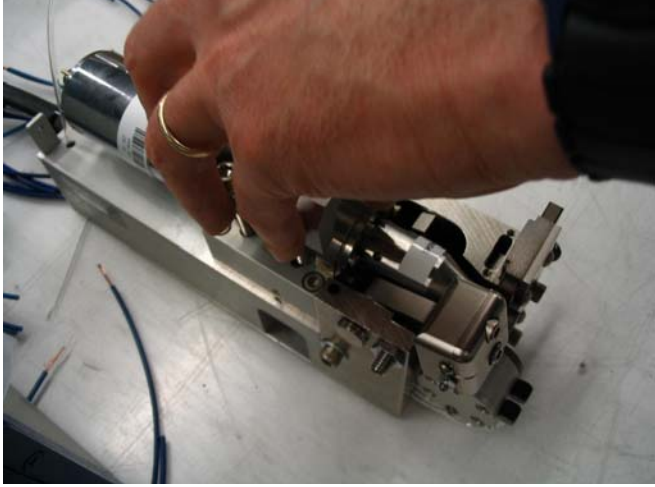
7.1.3.2 Ultrasonic Stack Assembly

Refer to [4.7 Ultrasonic Stack Assembly](#).

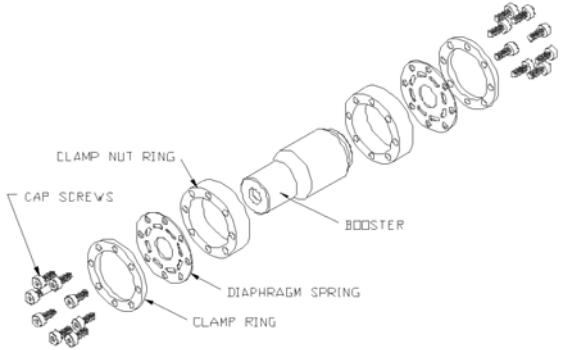
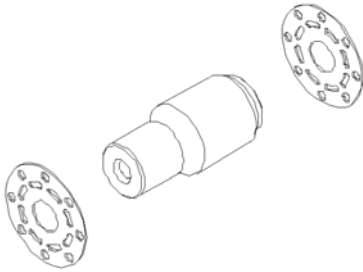
7.1.3.3 Reconditioning Tip and Nut Clamping Surfaces (Replaceable Tip Horns Only)

After prolonged use, burrs may form on the clamping surfaces of the tooling. These burrs may be removed from the Tip and Tip Nut by polishing with 600 grit emery paper placed on a flat surface. With light pressure, polish the clamp faces in a figure 8 pattern.

The burrs on the horn clamping surface must be removed by machining back the Horn clamp surface. The least amount of material should be removed, but in no case should more than .020" be removed. The undercut at this clamping surface must also be re-cut.

Figure 7.2 Reconditioning Tip and Nut Clamping Surfaces

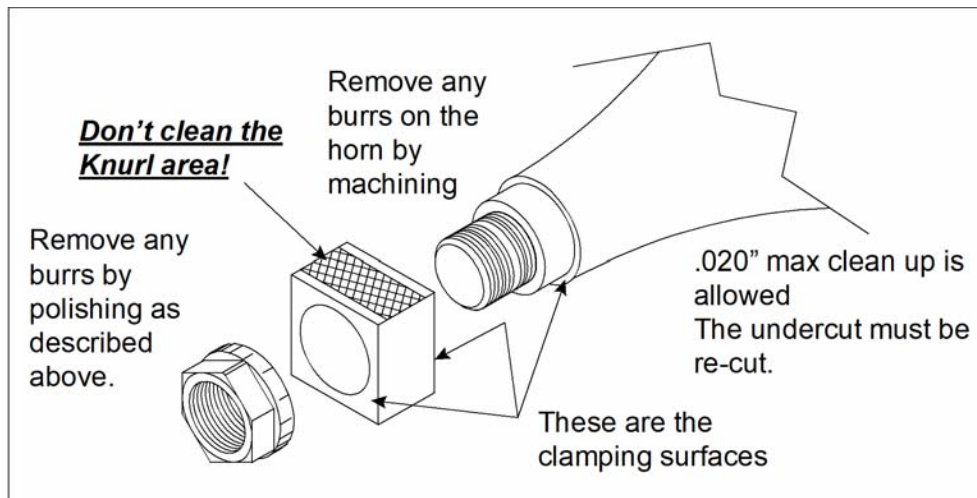



CAUTION	
	<p>In no case should more than .020" of material be removed from the Horn clamp surface.</p>

7.1.4 Rotating the Tip

The tip can also be rotated or replaced without removing the stack.

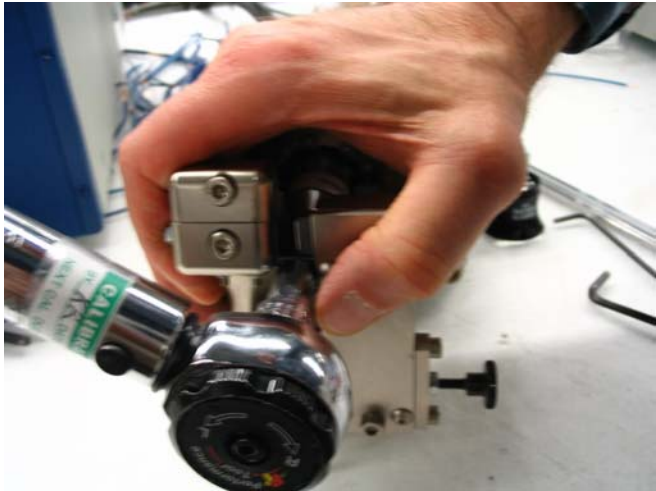
Table 7.3 Rotating the Tip

Action	Reference
<p>Remove the Tip Nut, Rotate the keyed Tip and re-install the Tip Nut.</p> <p>NOTE: LEFT HAND THREADS</p> <p>Torque to 125 in-lbs.</p>	 <p>A close-up photograph showing a person's hand adjusting a tip nut on a probe. The probe is held vertically, and the hand is turning the tip nut. A green label on the probe reads 'CALIBRATED BY BRANSON'. The background shows a workshop environment with various tools and equipment.</p>
<p>Completed Tooling Setup</p>	 <p>A close-up photograph of the completed tooling setup. The probe is mounted on a metal block, and the tip nut is securely fastened. The setup is shown from a side-on perspective, highlighting the precision of the assembly.</p>

7.2 Calibration

This product does not require scheduled calibration. However, if you are operating under requirements that mandate periodic calibration, for example, the FDA's Good Manufacturing Practices, contact your Branson Metal Welding representative for additional information.

7.2.1 Encoder Board Calibration

Encoder board calibration is factory set and generally does not need to be changed. Any calibration required due to tool wear or adjustment is built into the controller software and may be accomplished using touchscreen commands (refer to your power supply manual). If a new encoder board is installed it will be necessary to calibrate Height as follows.

Figure 7.3 Encoder Board Calibration

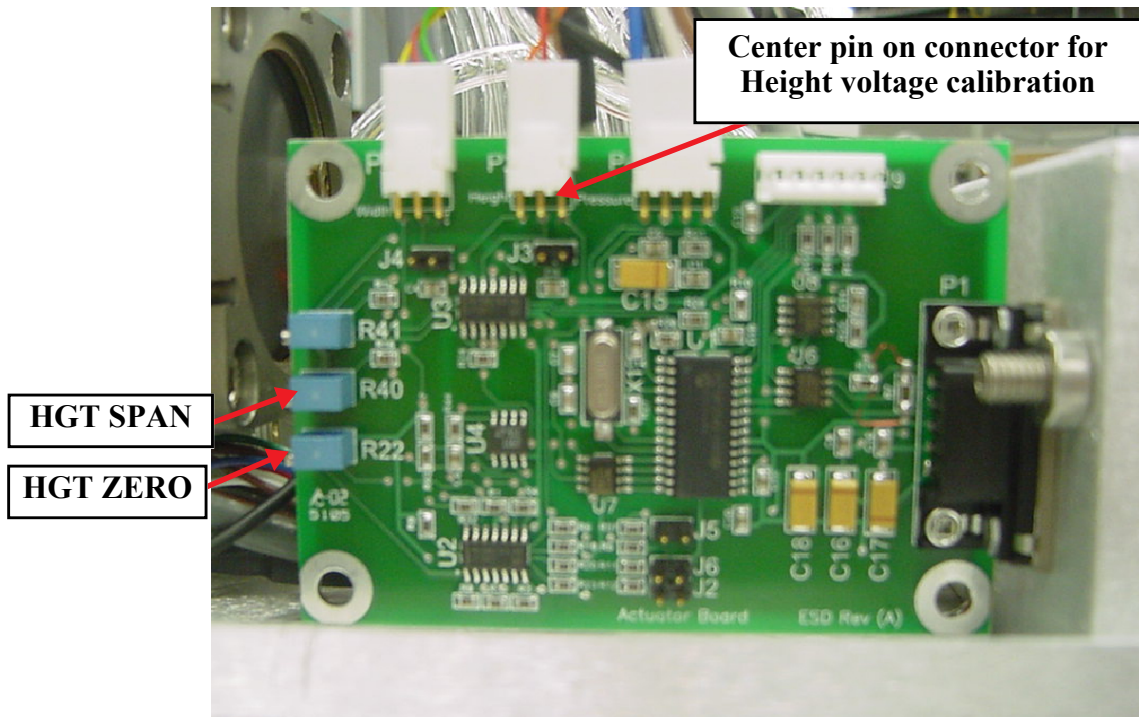

7.2.1.1 Height Zero and Span Adjustment

1. From the Controller Maintenance Screen, enter the Height Calibration Screen.
2. Press **HORN** button to lower the horn.
3. Remove the top cover from the actuator and locate the actuator board.
4. Read voltage that is displayed on controller screen.
5. Voltage should read between +2 to +5 millivolts DC. If not, adjust the HGT ZERO (R22) potentiometer (see [Figure 7.3](#)) until the voltmeter reads between +2 to +5 millivolts DC (voltage must be positive).
6. From the Controller Maintenance Screen, raise the horn (press **HORN** button).
7. Turn the HGT SPAN (R40) potentiometer (see [Figure 7.3](#)) to achieve the maximum possible voltage on the screen, then turn the potentiometer to lower the voltage until the voltage on the screen starts to come back down (the voltage should come down a maximum of 5 mV from the maximum attained voltage).

7.2.1.2 Height Calibration

CAUTION	
	Read all steps completely and exercise caution as tooling moves during the calibration process.

NOTICE	
	Readings are consistently better if the calibration is done at 25 PSI.

1. Position a 1 mm shim on the tip.
2. From the controller press CALIBRATE. The horn comes down 8 times on the 1 mm shim. "Calibration Step 1 done" message is displayed.
3. Position a 6 mm shim on the tip.
4. From the controller press CALIBRATE. The horn comes down 8 times on the 6 mm shim. "Calibration done" message is displayed. If message "Unsuccessful Calibration" is displayed, repeat steps 1 through 4.
5. Disconnect the RF cable from the actuator.
6. Set the weld mode to Time:
 - a. On a VersaGraphiX controller, on the Setup Screen go to Advanced Settings select Time as the weld mode.
 - b. On a Touchscreen controller, go to the Weld Mode screen (MENU>SETTINGS>WELD-MODE) and select Time as the weld mode.
7. Set the weld time to 0.2 s:
 - a. On a VersaGraphiX controller, on the Setup Screen, under Quality Settings press the button next to the time icon and enter a value of 0.2 s.
 - b. On a Touchscreen controller, go to the Weld Settings screen (MENU>SETTINGS) and press on the Time button and enter a value of 0.2 s.
8. Perform a weld cycle on a 1 mm shim.
9. Adjust height readings to account for tooling variations:
 - a. On a VersaGraphiX controller, on the Setup Screen go to Advanced Settings and enter a value of 1 to the measured height on the right-side column of the Height Off-set.
 - b. On a Touchscreen controller, go to the Adjustment screen and enter a value of 1 by touching the ADJUST button.
10. Connect the RF cable to the actuator.

7.2.1.3 Calibrate Width

NOTICE	
	Readings are consistently better if the calibration is done at 25 PSI.

1. Remove the top cover from the actuator and locate the actuator board.
2. From the Controller Maintenance Screen, press Zero button. The Gather will move to the zero width point.
3. Use the "<<" (fast adjust) button to close the Gather completely.
4. Press the "Gather" button, the gather should be at the zero width position.
5. The voltage on screen should read 600 mV.
6. If the voltage from step 5 reads 600 mV:
 - a. Insert a 6mm pin/shim, from the controller close the gather. Then press "CAL 1" button. (Use buttons "<<" and "-" to close the Gather and buttons ">>" and "+" to open the Gather.)
 - b. Insert a 1mm pin/shim, from the controller close the gather. Then press "CAL 2" button. (Use buttons "<<" and "-" to close the Gather and buttons ">>" and "+" to open the Gather.)
7. Message "Calibration was successful" is displayed. If not, repeat the calibration procedure.

7.3 Troubleshooting

This section shows how to fix some of the possible errors and problems which may occur in normal use of the Ultrasplice 40 welding system.

7.3.1 Weld Overload

Weld overloads are premature shut downs of the power supply. Overloads signify excessive loads and must be corrected if continued reliability of the equipment is to be maintained. Hardware internal to the supply are controlling this function and it can not be defeated.

The control system analyzes the end of weld characteristics to check for overloads. If the system determines an overload an alarm occurs. The control halts action until the system is reset.

Some of the possible causes for overloads are:

- The tool clearances are too small, horn and anvil touch during welding
- Excessive air pressure with low amplitude
- Defective Stack assembly
- Defective Power Transistors in power supply

7.3.2 Low Air Pressure

The control system and its components were designed to run with a clean air supply of from 90 to 120 psi. The control system monitors the air pressure from the low air pressure switch (optional). The low pressure threshold is set from the controller. An alarm occurs when incoming line pressure the drops below the set pressure.

7.3.3 Ready Check

The system undergoes a Ready Check operation at every startup, the end of every weld, and at the exit of Setup mode. This procedure checks the height encoder position. If an incorrect height value is returned, an alarm occurs.

Some of the possible causes of a Ready Check alarm are:

- The Anvil is stuck in the closed position
- Maintenance has moved the height encoder to an out of limit condition
- Defective encoder or electronics
- Encoder not plugged in to its connector

7.3.4 Troubleshooting Chart

Table 7.4 Troubleshooting Chart

Problem	Solution
System will not turn on.	Power cable plugged in. Power turned on at the outlet. Check internal fuses on the Controller Line Board.
Plant fuse fails or circuit breaker trips when plugging the unit into an electrical outlet.	Inspect power cord, replace if shorted. Check line filter, replace if failed.

Table 7.4 Troubleshooting Chart

Problem	Solution
Plant fuse fails or circuit breaker trips during weld cycle	Check current rating of the plant fuse or the circuit breaker, replace if failed.
Line fuse fails.	Check fuse current rating, replace if incompatible. Check fan motor, replace if failed.
Anvil will not move down or up.	System not connected to air supply. Air not turned on.
Get Emergency Stop when system is turned on.	Check Emergency Stop Switch. All cables properly connected. Twist red switch on foot pedal. (if system is equipped with one)
No Sonics when test button is pressed.	RF Cable connected. Check RF cable for broken wire. Ribbon cable in power supply between SPM and programmer unplugged.
No sonics during weld cycle	Check all cable connections. Check start cable for broken wires. Check inside power supply for loose start cable from rear of unit to programmer board. Check thermal switch in power supply.
Overloads when welding	Stack not tuned properly. Tooling not set up properly. Crash gap not set properly. Tip nut cracked, replace if needed. Check weld parameters. Check stack interfaces for fretting. Check for loose or failed horn or booster, tighten or replace as necessary.
When touching the system you get a slight electrical shock.	Inspect power cord, replace if needed. Inspect system ground, repair if needed.
Tooling heats up after machine runs a while.	Cooling air is not turned on or is not on long enough.

Table 7.4 Troubleshooting Chart

Problem	Solution
Low weld strength.	Check weld parameters. Check tooling gaps. Check knurl on tooling. If worn replace tooling. Increase Energy. Check the Down stop adjustment. Check for part contamination. Ensure all hardware is tight.
Excessive welding.	Reset parameters. Reset amplitude. Reset pressure. Measure and re-calibrate amplitude display.
Time limit error or peak power error displayed after weld cycle.	Reset limits. Check tip, rotate or replace if worn. Check anvil for wear, rotate or replace if worn. Check air pressure setting. Check up stop for proper adjustment. Process settings have to be opened up due to part variance or limits should be adjusted according to the part/wire being run. Check anvil clamp for proper torque.
Squealing sound during welding or when test key is depressed.	Check plate screws and tighten or replace. Check cover plate screws and tighten. Reset gaps. Re-square horn/tip and reset gaps. Reset horn tip and gap.
Weld heights are inconsistent.	Re-calibrate encoders with 1mm gauge. Ensure the connector for the encoder is tightly plugged into the actuator card.
Anvil is stuck in down position.	Check air pressure. Ensure air lines are installed properly. Check for kinks in air lines.
Air leaking from machine.	Ensure all air line connections are tight. Check for cracked or broken air lines.

Table 7.4 Troubleshooting Chart

Problem	Solution
Unusual sound during weld cycle.	Check tooling gap. Check converter. Check stack assembly.
Squealing sound from Controller when unit is turned on.	Check cooling fans in rear of unit
Maintenance counter alarm.	Reset maintenance counter.
Actuator moves sluggish.	Check air lines for contamination. Air must be filtered to 5 microns and be oil and water free. Check solenoid valve, replace if needed. Check air regulator.
System has READY CHECK message.	The anvil is stuck in the closed position. Maintenance has moved the height encoder to an out of limit condition. Defective encoder or electronics. Encoder not plugged into the actuator card.
Time, height and energy inconsistent.	Switch to energy mode & open height window. Make some sample welds. Check the time and the height of the welds for consistency. If the time or weld thickness varies greatly, check the air regulator.

7.4 Parts Lists

The following table lists items that are highly recommended to have readily available to prevent extended equipment down time and/or setup time.

Table 7.5 Primary Spare Items

Description	EDP Number
Linear Encoder	H4A50029
Spring, Front Diaphragm	100-095-168
Spring, Rear Diaphragm	100-095-169
Converter Model 4TH	101-135-067R

Periodic Maintenance Signoff Sheet

Date Machine was First put into Operation: _____/_____/_____

Name: _____ Signature: _____

Table 7.6 Periodic Maintenance Signoff Sheet

Date	Tool Rotation?	# of Cycles	Every Tool Rotation			Every One Million Cycles			
			Inspected Surfaces of Horn, Tip and Tip Nut (Initials)	Vacuumed and Cleaned Actuator (Initials)	Inspected Surfaces of Anvil, Anvil Block and Gather (Initials)	Vacuumed & Cleaned Power Supply (Initials)	Calibrated Pressure Regulator (Initials)	Cleaned & Torqued Stack Interface (Initials)	Calibrated Amplitude (Initials)

Weld Development and Quality

When properly set up the ULTRASPLICE System will produce quality welds by simply placing parts into the fixture and actuating the foot switch or actuator start switch.



Appendix A: Ultrasplice 40 Interconnect Diagram

A.1 Ultrasplice 40 Interconnect Diagram 86

A.1 UltrasplICE 40 Interconnect Diagram

Figure A.1 UltrasplICE 40 Interconnect Diagram

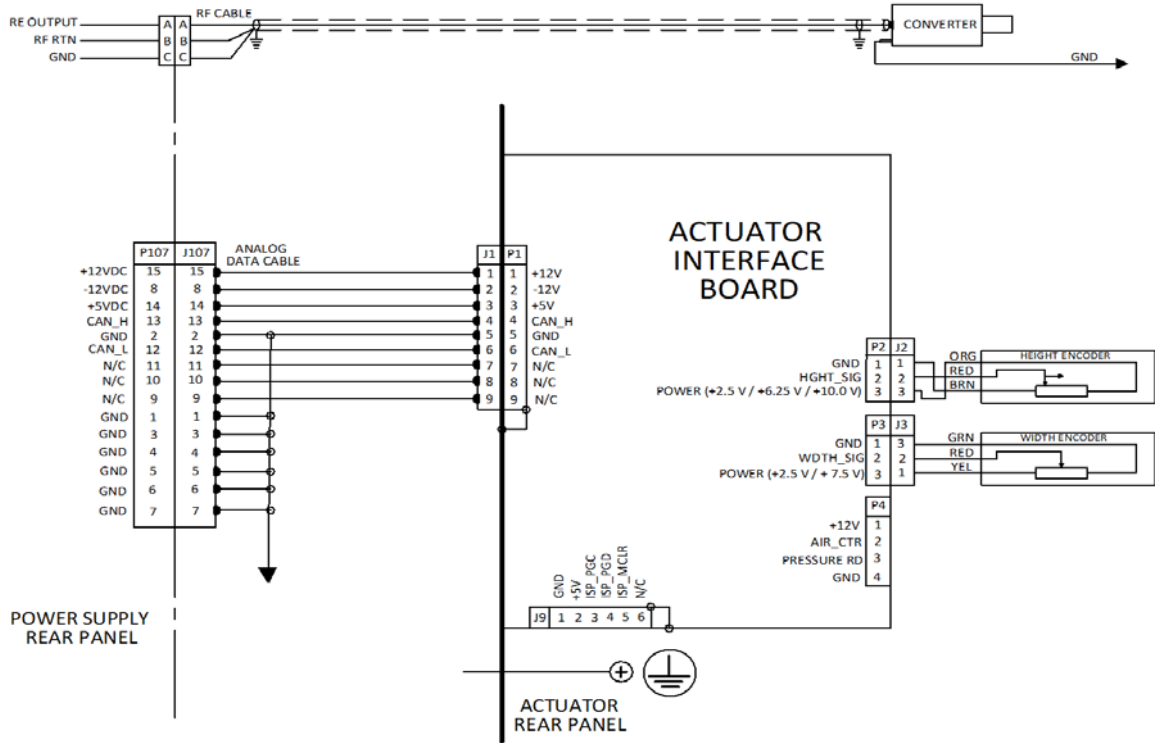

Appendix B: Declaration of Conformity

B.1 Declaration of Conformity 88

B.1 Declaration of Conformity

Figure B.1 Declaration of Conformity

EC DECLARATION OF CONFORMITY
according to the Machinery Directive 2006/42/EC Annex II A
EMC Directive 2004/108/EC, Annex IV 2

We, the manufacturer
BRANSON ULTRASONICS CORPORATION
41 Eagle Road
Danbury, CT USA 06813-1961

Represented in the community by
BRANSON ULTRASCHALL
Niederlassung der EMERSON Technologies GmbH & Co. OHG
Waldstraß 53-55
D-63128 Dietzenbach

Expressly declare that the machinery, to which this declaration applies,
in the state in which it was placed on the market,
fulfills all the relevant provisions of the Machinery Directive 2006/42/EC.

We also declare that this machinery is in conformity with the EMC Directive 2004/108/EC
And the safety objectives set out in the Low Voltage Directive 2006/95/EC were kept in accordance
With Annex 1 No. 1.5.1 of the Machinery Directive 2006/42/EC.

The product:
Ultrasplice® 40 Ultrasonic Splicing System
Consisting of a Branson Ultrasplice Model 40
Used with a
Branson 40 kHz Touchscreen or Versagraphix Power Supply
And interconnecting cables

to which this declaration relate are in conformity with the following harmonized standards:
EN ISO 12100-1: 2003/A1:2009, EN ISO 12100-2:2003/A1:2009, EN 60204-1:2006/A1:2009,
EN 13849-1:2008, EN 61310-1:2009, EN 61310-2:2009, EN 60529-1:2000, EN 14121-1:2007
EN ISO 13850:2008, EN 60664-1:2007, EN 61000-3-2:2006, EN 61000-3-3:2008,
EN 55011:2007 and EN 61000-6-2: 2005

Danbury, CT, USA Dec 2011



Roy Bullivant
Director, Engineering

Appendix C: Declaration of Incorporation

C.1 Declaration of Incorporation 90

C.1 Declaration of Incorporation

Figure C.1 Declaration of Incorporation

DECLARATION OF INCORPORATION
according to the Low Voltage Directive 2006/95/EC Annex IIIB
EMC Directive 2004/108/EC, Annex IV 2

We, the manufacturer
BRANSON ULTRASONICS CORPORATION
41 Eagle Road
Danbury, CT USA 06813-1961

Represented in the community by
BRANSON ULTRASCHALL
Niederlassung der EMERSON Technologies GmbH & Co. OHG
Waldstra 53-55
D-63128 Dietzenbach

Expressly declare that the machinery, to which this declaration applies,
in the state in which it was placed on the market,
fulfills all the relevant provisions of the Low Voltage Directive 2006/95/EC
And the EMC Directive 2004/108/EC

The product:
Ultrasplice® 40 Ultrasonic Splicing System
Consisting of a Branson Ultrasplice 40
Used with a
Branson 40 kHz Touchscreen or Versagraphix Power Supply
And interconnecting cables

to which this declaration relate are in conformity with the following harmonized standards:
EN ISO 12100-1:2003/A1:2009, EN ISO 12100-2:2003/A1:2009, EN 13849-1:2008
EN 60204-1:2006/A1:2009, EN 61310-1:2009, EN 61310-2:2009, EN 60529-1:2000, EN 14121-1:2007
EN ISO 13850:2008, EN 60664-1:2007, EN 61000-3-2:2006, EN 61000-3-3:2008,
EN 55011:2007 and EN 61000-6-2: 2005

IT IS FORBIDDEN TO PUT THIS EQUIPMENT INTO SERVICE UNTIL THE MACHINERY INTO
WHICH IT IS TO BE INCORPORATED HAS BEEN DECLARED IN CONFORMITY WITH THE
PROVISIONS OF THE MACHINERY DIRECTIVE

Danbury, CT, USA Dec 2011

Roy Bullivant
Director, Engineering

CE Marking Affixed: 06



EMERSON[™]

Original Instructions
DCM00002 - REV. 17



Welder

Touchscreen Controller

Operating Manual

Branson Ultrasonics Corp.
120 Park Ridge Road
Brookfield, CT 06804
(203) 796-0400
<http://www.bransonultrasonics.com>

BRANSON

Manual Change Information

At Branson, we strive to maintain our position as the leader in ultrasonics metal welding, plastics joining, ultrasonic cleaning, and related technologies by continually improving our circuits and components in our equipment. These improvements are incorporated as soon as they are developed and thoroughly tested.

Information concerning any improvements will be added to the appropriate technical documentation at its next revision and printing. Therefore, when requesting service assistance for specific units, note the revision information found on this document, and refer to the printing date which appears on this page.

Copyright and Trademark Notice

Copyright © 2025 Branson Ultrasonics Corp. All rights reserved. Contents of this publication may not be reproduced in any form without the written permission of Branson Ultrasonics Corp.

WD-40 is a registered trademark of WD-40 Manufacturing Company Corporation.

Windows is a registered trademark of Microsoft Corporation.

Other trademarks and service marks mentioned herein are held by their respective owners.

Foreword

Congratulations on your choice of a Branson system!

The Branson Touchscreen Controller system is a process equipment for the joining of metal parts using ultrasonic energy. It is the newest generation of product using this sophisticated technology for a variety of customer applications. This Operating Manual is part of the documentation set for this system, and should be kept with the equipment.

Thank you for choosing Branson!

Introduction

This manual is arranged into several structured chapters which will help you find the information you may need to know to safely handle, install, set up, program, operate, and/or maintain this product. Please refer to the [Table Of Contents](#) of this manual to find the information you may be looking for. In the event you require additional assistance or information, please contact our Product Support department (see [1.5 How to Contact Branson](#) for information on how to contact them) or your local Branson representative.

NOTICE	
	<p>This document is intended for use with the following Branson products: Touchscreen Controller with a Welder.</p>

This Instruction Set includes information for the Touchscreen Controller and actuator. Please refer to the [Table Of Contents](#) of this Instruction Set to find specific information.



Table Of Contents

Chapter 1: Safety and Support

1.1	Safety Requirements and Warnings	2
1.2	General Precautions	4
1.3	Regulatory Compliance	5
1.4	Warranty	6
1.5	How to Contact Branson	7
1.6	Returning Equipment for Repair	8
1.7	Obtaining Replacement Parts	10

Chapter 2: Introduction

2.1	Introduction	12
2.2	Model Covered	13
2.3	Overview of this Model	14
2.4	Compatibility with Branson Products	17
2.5	Ultrasonic Theory	18
2.6	Terminology	24

Chapter 3: Shipping and Handling

3.1	Shipping and Handling	28
3.2	Receiving	29
3.3	Unpacking	30
3.4	Returning Equipment	31

Chapter 4: Technical Specifications

4.1	Environmental Requirements	34
4.2	Electrical Requirements	35
4.3	Pneumatic Requirements	36

Chapter 5: Operation

5.1	Before Operating the Unit	38
5.2	Run Screen	39
5.3	Menu Options Screen	41
5.4	Weld Settings Screen	43
5.5	Weld Mode Screen	45
5.6	Advanced Weld Settings Screen	47
5.7	Preset Menu Screen	48
5.8	Preset Name Screen	49
5.9	Preset Library Screen	50
5.10	Maintenance Menu Screen	51
5.11	Height Calibration Screen	53
5.12	Sonic Generator Screen	54
5.13	Sending Screen	55
5.14	Maintenance Counters and Limits Screen	56
5.15	Weld Limits Screen	57
5.16	Sequence Menu Screen	58
5.17	Sequence Name and Edit Screen	59
5.18	Sequence Steps Screen	60
5.19	Sequence Library Screen	61
5.20	Height Adjustment Screen	62

5.21	System Configuration Screen	63
5.22	Cooling Screen	64
5.23	Teach Mode Setup Screen	65
5.24	System Configuration Screen (Next)	67
5.25	Actuator Selection Screen	68
5.26	Password Changing Screen	69
5.27	Low Air Alarm Screen	70
5.28	System Configuration Screen (Next, Next)	71
5.29	Transducer Configuration Screen	72
5.30	Sequence Error Screen	73
5.31	Gateway Feature	74
5.32	Diagnostic Screen	75
5.33	Serial Port Diagnostic Screen	76
5.34	Cycles Screen	77
5.35	Typical Keypad Entry Screen	78
5.36	Advanced Function Switch Select	79
5.37	Saving/Transferring Preset and Sequence Information	80
5.38	Safety Circuit Alarms	82
 Chapter 6: Maintenance		
6.1	Preventive Maintenance	84
6.2	Parts Replacement	85
6.3	Parts List	86

List Of Figures

Chapter 1: Safety and Support

Chapter 2: Introduction

Figure 2.1	Metal Welding Power Supply	14
Figure 2.2	The CPU Board	16
Figure 2.3	How does Ultrasonic Welding Work?	18
Figure 2.4	Weld Power Graph for clean components, dirty components, and when part is missing	20
Figure 2.5	Pressure Variable with Increased Power	20
Figure 2.6	Pressure Variable with Increased Time	21
Figure 2.7	Scrubbing Action on Weld Interface	21
Figure 2.8	Amplitude's Influence on Weld Power and Time	22
Figure 2.9	Amplitude Stepping Profile	22
Figure 2.10	Harmonic Resonance on Ultrasonic Tooling	23

Chapter 3: Shipping and Handling

Chapter 4: Technical Specifications

Chapter 5: Operation

Figure 5.1	Run Screen	39
Figure 5.2	Menu Options screen	41
Figure 5.3	Weld Settings screen	43
Figure 5.4	Weld Mode screen	45
Figure 5.5	Advanced Weld Settings screen	47
Figure 5.6	Preset Menu screen	48
Figure 5.7	Preset Name screen	49
Figure 5.8	Preset Library screen	50
Figure 5.9	Maintenance Menu screen	51
Figure 5.10	Height Calibration screen	53
Figure 5.11	Sonic Generator screen	54
Figure 5.12	Sending Screen	55
Figure 5.13	Maintenance Counters and Limits screen	56
Figure 5.14	Weld Limits screen	57
Figure 5.15	Sequence Menu screen	58
Figure 5.16	Sequence Name and Edit screen	59
Figure 5.17	Sequence Steps screen	60
Figure 5.18	Sequence Library screen	61
Figure 5.19	Height Adjustment screen	62
Figure 5.20	System Configuration screen	63
Figure 5.21	Cooling screen	64
Figure 5.22	Teach Mode Setup screen	65
Figure 5.23	System Configuration screen (Next)	67
Figure 5.24	Actuator Selection screen	68
Figure 5.25	Password Changing screen	69
Figure 5.26	Low Air Alarm screen	70
Figure 5.27	System Configuration screen (Next, Next)	71
Figure 5.28	Transducer Configuration screen	72
Figure 5.29	Sequence Error screen	73

Figure 5.30 Enabling the Gateway feature	74
Figure 5.31 Diagnostic screen	75
Figure 5.32 Serial Port Diagnostic screen	76
Figure 5.33 Cycles screen	77
Figure 5.34 Typical Keypad Entry screen	78
Figure 5.35 Advanced Functions Dip Switch	79

Chapter 6: Maintenance

Figure 6.1 Touchscreen Controller - Top view with cover removed	87
---	----

List Of Tables

Chapter 1: Safety and Support

Table 1.1	Symbols found on the product	3
-----------	--	---

Chapter 2: Introduction

Table 2.1	Touchscreen Controller compatibility with Branson Metal Welding Converters	17
Table 2.2	Calculating Power	19
Table 2.3	Calculating Energy	19

Chapter 3: Shipping and Handling

Table 3.1	Environmental Requirements	28
Table 3.2	Inspection procedure after delivery	29
Table 3.3	Unpacking	30

Chapter 4: Technical Specifications

Table 4.1	Environmental Requirements	34
Table 4.2	Electrical Input Operating Voltages	35
Table 4.3	Input Current and Fuse Requirements	35

Chapter 5: Operation

Table 5.1	Advanced Function Switch Select Table	79
Table 5.2	HyperTerminal Connection	80
Table 5.3	RS232 Serial Port Configuration	80

Chapter 6: Maintenance

Table 6.1	Suggested spares	86
-----------	----------------------------	----



Chapter 1: Safety and Support



1.1	Safety Requirements and Warnings	2
1.2	General Precautions	4
1.3	Regulatory Compliance	5
1.4	Warranty	6
1.5	How to Contact Branson	7
1.6	Returning Equipment for Repair	8
1.7	Obtaining Replacement Parts	10

1.1 Safety Requirements and Warnings

This chapter contains an explanation of the different Safety Notice symbols and icons found both in this manual and on the product itself and provides additional safety information for ultrasonic welding. This chapter also describes how to contact Branson for assistance.

1.1.1 Symbols found in this Manual



These symbols used throughout the manual warrant special attention:

WARNING	Indicates a possible danger
	If these risks are not avoided, death or severe injury might be the result.
CAUTION	Indicates a possible danger
	If these risks are not avoided, slight or minor injury might result.
NOTICE	Indicates a possible damaging situation
	If this situation is not avoided, the system or something in it's vicinity might get damaged. Application types and other important or useful information are emphasized.

1.1.2 Symbols found on the Product

The Touchscreen Controller has several warning labels on it to indicate the presence of hazardous voltages inside the unit.

Table 1.1 Symbols found on the product

Symbol	Description
	Warning. Ground the unit before operating.
	High Voltage. Risk of electric shock or burn. Do not remove cover. Refer service to qualified personnel only.

1.2 General Precautions

Take the following precautions before servicing the Touchscreen Controller:

- Be sure the power switch is in the Off position before making any electrical connections
- To prevent the possibility of an electrical shock, always plug the Touchscreen Controller into a grounded power source
- Power supplies produce high voltage. Before working on the Touchscreen Controller module, do the following:
 - Turn off the Touchscreen Controller;
 - Unplug main power; and
 - Allow at least 5 minutes for capacitors to discharge
- High voltage is present in the Touchscreen Controller. Do not operate with the cover removed
- High line voltages exist in the ultrasonic Touchscreen Controller module. Common points are tied to circuit reference, not chassis ground. Therefore, use only non-grounded, battery-powered multimeters when testing these modules. Using other types of test equipment can present a shock hazard
- Be sure power is disconnected from the Touchscreen Controller before setting a DIP switch
- Keep hands away from the horn. Force (pressure) and ultrasonic vibrations can cause injury
- Do not cycle the welding system if either the RF cable or converter is disconnected

CAUTION	Loud Noise Hazard
	<p>Sound level emissions of up to 84.9 dB have been measured using a standard test load. To prevent the possibility of hearing loss, use appropriate hearing protection.</p>

NOTICE	
	<p>Sound level emissions of up to 84.9 dB have been measured using a standard test load. To prevent the possibility of hearing loss, use appropriate hearing protection.</p> <p>Sound level and frequency of the noise emitted during the ultrasonic assembly process may depend upon a. type of application, b. size, shape and composition of the material being assembled, c. shape and material of the holding fixture, d. welder setup parameters and e. tool design. Some parts vibrate at an audible frequency during the process.</p> <p>Some or all of these factors may result in sound levels of up to 84.9 dB. In such cases operators may need to be provided with personal protective equipment. See 29 CFR (Code of Federal Regulations) 1910.95 Occupational Noise Exposure. For all other countries, follow your local regulations.</p>

1.2.1 Intended Use of the System

The Branson Touchscreen Controller and Actuator are components of an ultrasonic welding system. These are designed for a wide variety of welding or processing applications.

1.3 Regulatory Compliance

This product meets electrical safety requirements and EMC (Electromagnetic Compliance) requirements for North America and the European Union.

1.4 Warranty

For warranty information please reference the warranty section of Terms and Conditions found at: www.emerson.com/branson-terms-conditions.

1.5 How to Contact Branson

Branson is here to help you. We appreciate your business and are interested in helping you successfully use our products. To contact Branson for help, use the following telephone numbers, or contact the field office nearest you.

- **Brookfield Main Number (all departments):** (203) 796-0400 (Eastern Time Zone)
- **Parts Store:** Direct Number for Parts Store in Brookfield (203) 796-9807

Tell the operator which product you have and which person or department you need. If after hours, please leave a voice message with your name and return telephone number.

1.5.1 Before Calling Branson for Assistance

This manual provides information for troubleshooting and resolving problems that could occur with the equipment (see [Chapter 6: Maintenance](#)). If you still require assistance, Branson Product Support is here to help you. To help identify the problem, use the following questionnaire which lists the common questions you will be asked when you contact the Product Support department.

Before calling, determine the following information:

1. Your company name and location.
2. Your return telephone number.
3. Have your manual with you.
4. Know your equipment model and serial numbers (found on a gray data label on the units). Information about the Horn (part number, gain, etc.) or other tooling may be etched into the tooling. Software- or firmware-based systems may provide a BIOS or software version number, which may be required.
5. What tooling (horn) and booster are being used?
6. What are the setup parameters and mode?
7. Is your equipment in an automated system? If so, what is supplying the “start” signal?
8. Describe the problem; provide as much detail as possible. For example, is the problem intermittent? How often does it occur? How long before it occurs if you are just powering up? If an error is occurring, which error (give error number or name)?
9. List the steps you have already taken.
10. What is your application, including the materials being processed?
11. Have a list of service or spare parts you have on hand (tips, horns, etc.).
12. Notes:

1.6 Returning Equipment for Repair

NOTICE	
	To return equipment to Branson, you must first obtain an RGA number from a Branson representative, or the shipment may be delayed or refused.

If you are returning equipment to Branson for repair, you must first call the Repair department to obtain a Returned Goods Authorization (RGA) number. (If you request it, the repair department will fax a Returned Goods Authorization form to fill out and return with your equipment).

Branson Repair Department

120 Park Ridge Road

Brookfield, CT 06804, U.S.A.

Direct telephone number: (203) 796-0807

Fax number: (203) 796-0574

- Provide as much information as possible that will help identify the need for repair
- Carefully pack the equipment in original packing cartons
- Clearly label all shipping cartons with the RGA number on the outside of cartons as well as on your packing slip, along with the reason for return
- Return general repairs by any convenient method. Send priority repairs by air freight
- You must prepay the transportation charges FOB Brookfield, Connecticut, U.S.A.

1.6.1 Get an RGA Number

RGA# _____

If you are returning equipment to Branson, please call the Repair Department to obtain a Returned Goods Authorization (RGA) number. (At your request, the Repair Department will fax an RGA form to fill out and return with the equipment).

1.6.2 Record information about the Problem

Before sending equipment for repair, record the following information and send a copy of it with the equipment. This will greatly increase Branson's ability to address the problem.

1. Describe the problem; provide as much detail as possible. For example, is the problem intermittent? How often does it occur? How long before it occurs after powering up?

2. Is your equipment in an automated system?

3. If the problem is with an external signal, which signal?

If known, include plug/pin # (e.g., P29, pin #3) for that signal:

4. What are the Weld Parameters?

5. What is your application? (Type of weld, metal material, etc.).

6. Name and phone number of the person most familiar with the problem:

7. Contact the Branson office prior to shipping the equipment.

8. For equipment not covered by warranty, to avoid delay, include a Purchase Order.

Send a copy of this page with the equipment being returned for repair.

1.6.3 Contact Information

Call your local Branson Representative, or contact Branson by calling (203) 796-0400.

1.6.4 Pack and Ship the Equipment

1. Carefully pack the system in original packing material to avoid shipping damage. Plainly show the RGA number on the outside of cartons as well as inside the carton along with the reason for return. Make a list of all components packed in the box. **KEEP YOUR MANUAL.**
2. Return general repairs by any convenient method. Send priority repairs by air freight. Prepay the transportation charges FOB the repair site (either the Branson field office or Brookfield, Connecticut USA location).

NOTICE	
	<p>Items that are sent Freight Collect will be refused.</p>

1.7 Obtaining Replacement Parts

You can reach the Branson Parts Store at the following telephone numbers:

- Direct Telephone Number: (203) 796-9807
- Fax number: (203) 926-2678

Many parts can be shipped the same day if ordered before 2:30 p.m., Eastern time.

A parts list is found in [Chapter 6: Maintenance](#) of this manual, listing descriptions and EDP part numbers. If you need replacement parts, coordinate the following with your purchasing agent:

- Purchase order number
- Ship to information
- Bill to information
- Shipping instructions (air freight, truck, etc.)
- Any special instructions (for example, "Hold at the airport and call"). Be sure to give a name and phone number
- Contact name information

Chapter 2: Introduction

2.1	Introduction	12
2.2	Model Covered	13
2.3	Overview of this Model.	14
2.4	Compatibility with Branson Products.	17
2.5	Ultrasonic Theory	18
2.6	Terminology	24

2.1 Introduction

This manual provides detailed instructions for the setup, operation, and maintenance of the Branson Touchscreen Controller. For detailed information on operation and maintenance of other components connected to the Touchscreen Controller, refer to appropriate Actuator instruction manual.

The Touchscreen Controller contains a microprocessor-based controller that provides for control and monitoring of welding operations.

2.2 Model Covered

This document is intended for use with a Touchscreen Controller. This document is intended for use in conjunction with others to form a complete manual for your Branson system. Please refer to the [Table Of Contents](#) of this Instruction Set to find specific information.

2.3 Overview of this Model

Figure 2.1 Metal Welding Power Supply



The Branson welder generates ultrasonic electrical energy through an ultrasonic converter for welding metals. Several models are available, depending on the desired frequency (for example, 20 kHz) or the desired power range (for example, 2.2 kW). The Touchscreen Controller also contains a microprocessor-based controller module that provides for control and monitoring of welding operations.

Ultrasonic Power Supply Module

Generates ultrasonic energy at the resonant frequency of the Converter-Booster-Horn Stack. The Ultrasonic Power Supply Module contains five main circuits as follows:

- 320VDC Power Supply: Converts AC line voltage to +320VDC for the output power devices
- FET bridge: Switches the 320 VDC into ultrasonic pulses at the resonant frequency
- Output circuit: matches the impedance of the output power device to the Converter-Booster-Horn- Stack; and provides feedback to the Control circuit

Control circuits: Perform the following functions:

- Provide drive signal to output power device
- Determine true percentage of ultrasonic power used over a range of amplitudes
- Allows control of the resonant frequency
- Control starting amplitude

System Protection: Protects the Power Supply by providing five levels of protection:

- Voltage
- Current
- Phase
- Temperature
- Power

Line Board Module

Performs the dual function of providing RFI filtering for the line voltage input to the power supply, and controlling the electrical current surge to the ultrasonic Power Supply Module at power up until the inrush current limiter relay engages. The filtering also blocks ultrasonic signals from entering the AC main line. Additionally, the Line Board contains a soft start circuit module which limits the effects of current inrush.

DC Power Module- rectifies, filters, and regulates the AC voltages from the Line into DC voltages for the CPU Board. These two circuits are described below:

- 5VDC output: provides +5VDC for the analog and digital circuitry on the CPU Board
- 24VDC output: provides +24VDC for the CPU Board control signal and user I/O voltage

The DC Power Supply is mounted to the rear of the Power Supply case. It is mounted so it will swivel up to service the DC Power Supply, Line Board, and fuses.

Machine Controller Board

Provides a standard interface for automation and is accessed on the rear of the power supply. It gives the customer the ability to make their own interface for automation or special control and/or special reporting needs. It is mounted to the CPU Board on standoffs, and is connected to the rear of the controller case by its end panel.

CPU Board

Controls the following functions of the Power Supply:

- Responding to start and stop signals
- Responding to alarm and reset signals
- Responding to user input from the front panel
- Activating and monitoring ultrasonics
- Provides information for Front Panel Displays
- Generate alarms
- Sending Weld data via RS232 serial communication
- Control communications

This board mounted to the bottom of the power supply box on standoffs and is connected to the rear of the controller case by its end panel. To access this board, removal of the Machine Controller Board is required. The system software resides in U1 as shown in [Figure 2.2](#).

Figure 2.2 The CPU Board

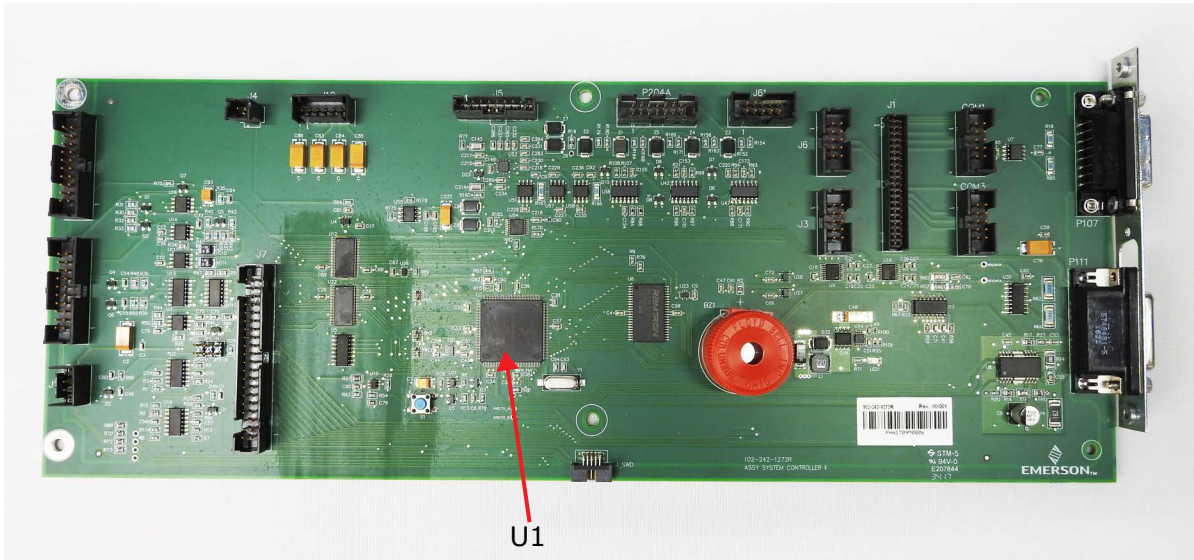

Front Touchscreen Panel and Bezel Assembly

It is held by four upper screws which are accessible from inside the enclosure and four lower screws which are accessible from outside the enclosure through the ventilation slots in the bezel. Removal of the front bezel allows access to the following components which are housed inside it:

- **Touchpanel:** The sensing element which provides the user interface with the controller
- **LCD Screen:** The visual display through which instructions are communicated to the user. It is mounted directly behind the touchpanel
- **Display Board:** Contains the video control circuits for the LCD Screen. This board is mounted directly behind the LCD controller
- **Front Panel Board:** Houses the alarm beeper and the four diagnostic lights which are located to the right of the touchscreen on the front bezel
- **Power Switch:** Used to turn the Controller on and off

Motor Control Board

Contains the control circuit for controlling actuators which are equipped with a stepper motor driven gather mechanism.

Pneumatic Kit

Refer to the Special Information Instruction Set.

2.4 Compatibility with Branson Products

The Branson Touchscreen Controller is designed to be used with:

- Branson Metal Welding Actuators: Ultraweld 20, Ultraweld 40, MTS 20, Ultrasplice 40, ST 40, MWX100
- Branson Metal Welding Converters: See [Table 2.1](#) below.

Table 2.1 Touchscreen Controller compatibility with Branson Metal Welding Converters

Branson Model	Converter
20 kHz/3300 W 20 kHz/4000 W	503, 105
30 kHz/1500 W	CR-30
40 kHz/800 W	4TJ, 4TR, 4TH

2.5 Ultrasonic Theory

2.5.1 What Is An Ultrasonic Weld?

Ultrasonic welding joins metal parts by applying the energy of high frequency vibrations onto the interface area between the parts to be welded.

2.5.1.1 How Does It Work?

Electrical Energy is transformed into high frequency mechanical vibration. This mechanical vibration is transferred to a welding tip through an acoustically tuned horn. The parts are “scrubbed” together under pressure at 20,000 or 40,000 cycles per second. This high frequency vibration, applied under force, disperses surface films and oxides, creating a clean, controlled, diffusion weld. As the atoms are combined between the parts to be welded, a true, metallurgical bond is produced.

Figure 2.3 How does Ultrasonic Welding Work?

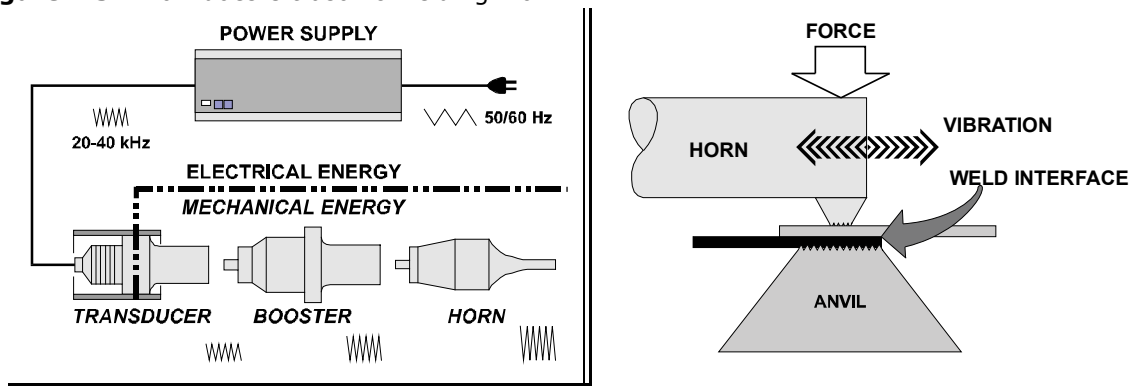

2.5.2 Benefits of Ultrasonic Welding

Ultrasonic metal welding exhibits unique welding properties that include:

- Excellent electrical, mechanical, and thermal connections between similar and dissimilar metals
- Low heat build up during the ultrasonic process (no annealing of materials)
- Compensation for normal surface variations of the material
- Ability to clean surface oxides and contaminants prior to welding
- Ability to weld large areas using minimal energy
- Ability to weld thin materials to thick materials
- Low cost per weld

2.5.3 How Is An Ultrasonic Weld Made?

Although the theoretical process of producing an ultrasonic weld is uncomplicated, the interactions of the various weld parameters are important and should be understood. When producing an ultrasonic weld, there are three primary variables that interact; they are:

- **Time:** The duration of applied ultrasonic vibration
- **Amplitude:** The longitudinal displacement of the vibration
- **Force:** The compressive force applied perpendicular (normal) to the direction of vibration

The power required to initiate and maintain vibration (motion) during the weld cycle can be defined as:

Table 2.2 Calculating Power

$$P = F \times A \times f$$

Where:

- P = Power (watts)
- F = Force* (N)
- A = Amplitude (microns)
- f = Frequency (Hertz)

*Force = (Surface Area of the Cylinder) X (Air Pressure) X (Mechanical Advantage)

Energy is calculated as;

Table 2.3 Calculating Energy

$$E = P \times T$$

Where:

- E = Energy (joules)
- P = Power (watts)
- T = Time (seconds)

Thus the complete 'Weld To Energy' process would be defined as:

$$E = (F \times A \times f) \times T$$

A well designed ultrasonic metal welding system will compensate for normal variations in the surface conditions of the metals by delivering the specified energy value. This is achieved by allowing Time (T) to adjust to suit the condition of the materials and deliver the desired energy.

2.5.4 Welding To Energy - Why?

Most metal welding applications are produced by 'Welding To Energy' in order to compensate for the various surface oxides and contaminants associated with the metals being joined. In a few applications 'Welding To Time' or 'Welding To Height' will yield better results. Since the majority of all metal welds are produced using energy as the controlling factor we will confine our discussion to that condition.

Welding to energy is necessary because of the non-metallic oxides that form on the metal's surface as well as other contaminants such as grease and dirt. To produce quality welds reliably it is necessary that the surfaces to be joined are clean. The high frequency scrubbing action, combined with pressure, cleans the weld interface at the beginning of the weld process.

The following graph ([Figure 2.4 Weld Power Graph for clean components, dirty components, and when part is missing](#)) illustrates a weld produced. The weld 'power graph' is sometimes referred to as weld 'footprint'. It can be used to visualize the weld cycle and assists in parameter optimization. Graphs from consecutive welds will vary slightly as the system dynamically adjusts time to accommodate varying surface conditions. The weld power data is gathered by sampling the power used in 5 millisecond intervals.

Figure 2.4 Weld Power Graph for clean components, dirty components, and when part is missing

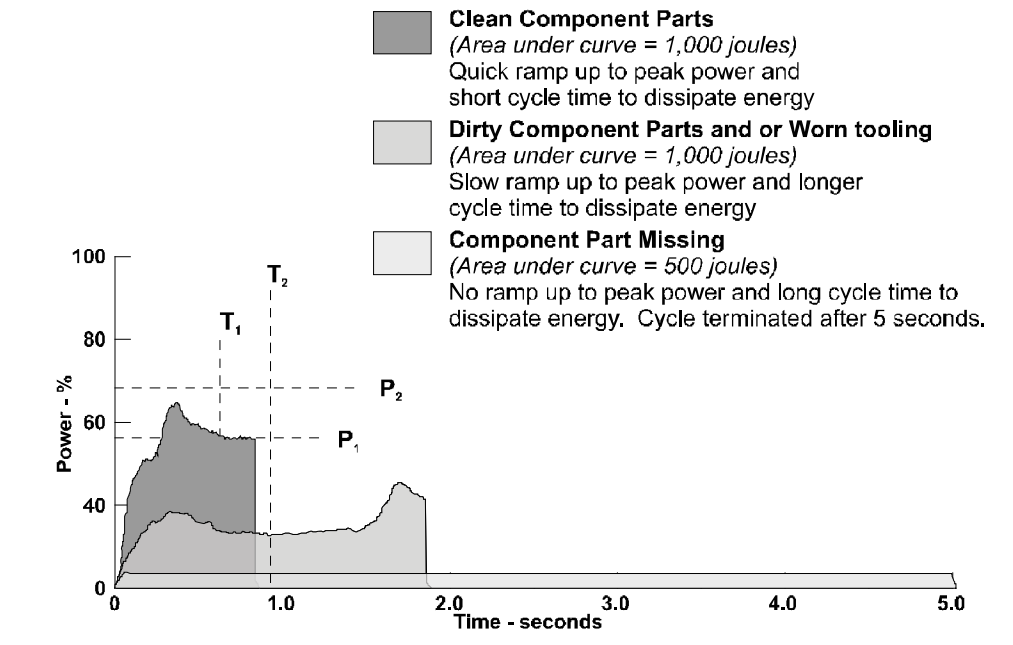

2.5.5 Power

The converter/booster/horn, (stack assembly), requires minimal electrical power to initiate and maintain motion (vibration) at a 'no-load' condition. As the mechanical load increases, the power required to maintain the mechanical vibration also increases. The maximum power required during a weld cycle is 'Peak Power'.

By increasing Pressure and maintaining all other parameters, the mechanical load or force on the weld joint increases, therefore, the amount of Power required to maintain the vibration of the stack increases. Subsequently, because of the increased Power Level, less time is required deliver the same amount of Energy. This relationship is illustrated on [Figure 2.5](#).

Figure 2.5 Pressure Variable with Increased Power

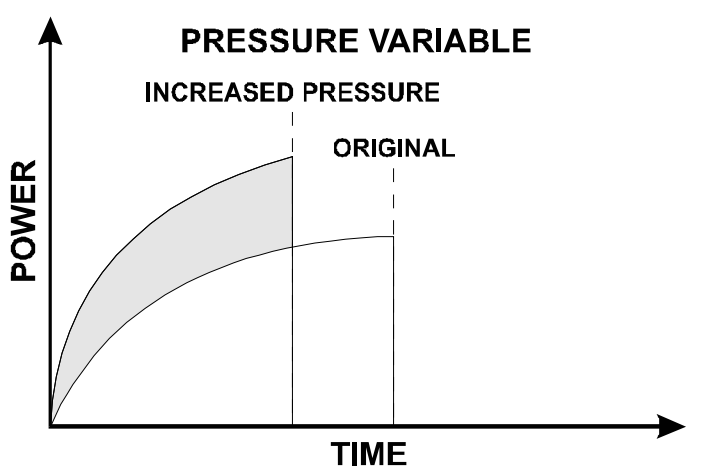

The difference in the appearance of each of the above weld graphs is the result of increased Power loading. Based upon an increase in Pressure, additional Power is required to maintain the motion of vibration. Thus, the same amount of energy is delivered in less time. This approach is typically used to raise the loading of the power supply during a weld cycle to the desired level as determined by the application.

2.5.6 Time

The time required to deliver the necessary energy is defined as the Weld Time. For most welds, the time required will be less than one second. If more energy is required and all other weld parameters are maintained, the weld time will increase ([Figure 2.6](#)).

Figure 2.6 Pressure Variable with Increased Time

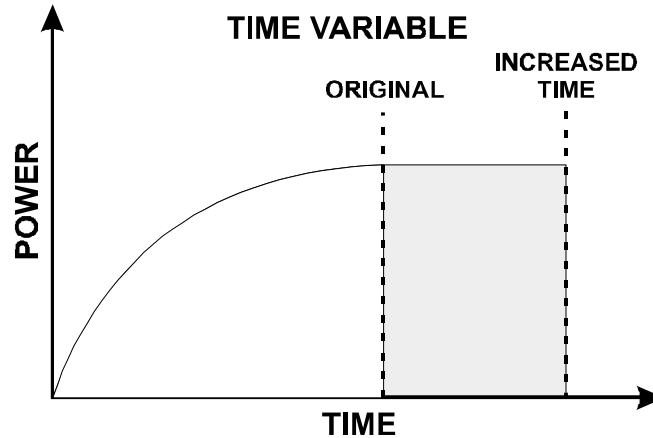

2.5.7 Amplitude

An ultrasonic tool is a resonant acoustical device. The term Amplitude is used to describe the amount of longitudinal expansion and contraction that the tooling endures as it vibrates ([Figure 2.7](#)). The amplitude correlates to the scrubbing action at the weld interface. This scrubbing action combined with pressure is what advances the weld by a diffusing or mixing of the base materials.

Figure 2.7 Scrubbing Action on Weld Interface

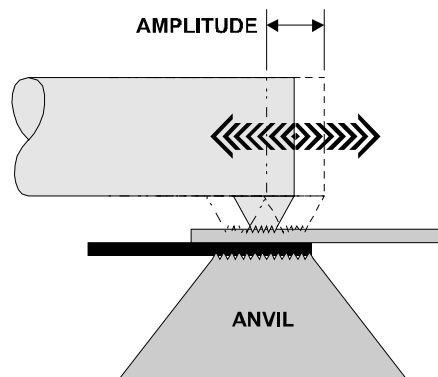

As previously mentioned, the converter/booster/horn, (stack assembly), requires minimal electrical power to initiate and maintain vibration in a 'no-load' condition. As the amplitude increases, the power required to maintain the increased velocity of vibration also increases. Subsequently, because of the increased Power less time is required deliver the same amount of Energy. This relationship is illustrated in the following power diagram (Figure 2.8):

Figure 2.8 Amplitude's Influence on Weld Power and Time

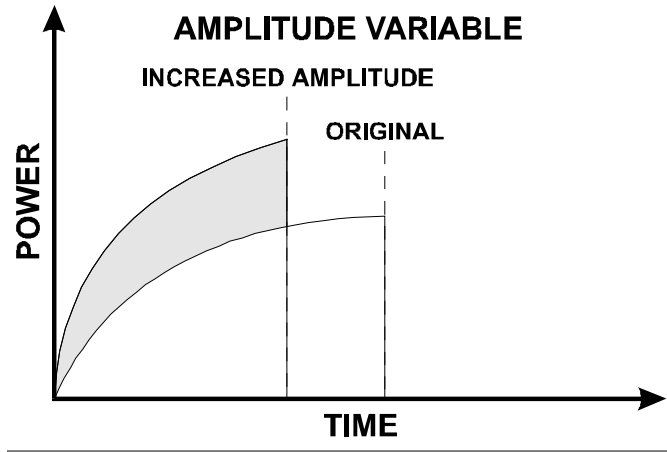

2.5.8 Amplitude Stepping

In standard practice, the scrubbing amplitude at the weld interface is maintained constant during a weld cycle. Recent advances in technology have made it possible to change the amplitude of the horn face during the weld cycle. This is known as Amplitude Profiling. Figure 2.9 illustrates a typical profile where the amplitude is reduced during the cycle. This type of profile is used mostly with welding aluminum to increase weld strength and to help prevent sticking to the tooling.

Figure 2.9 Amplitude Stepping Profile

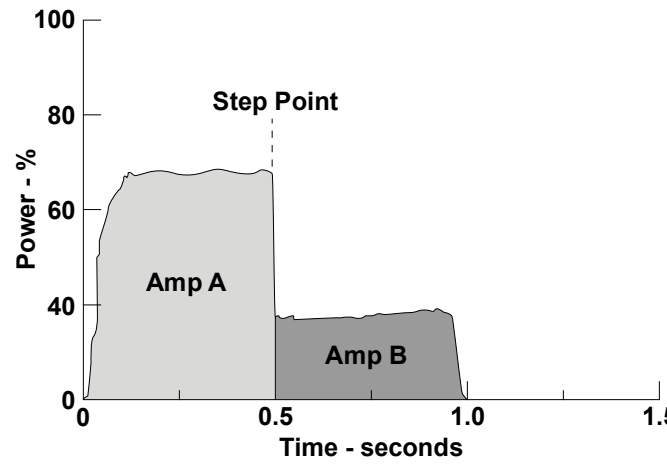

2.5.9 Resonant Frequency

The ultrasonic tooling acts as a spring having node points and anti-node points. The mechanical energy used to vibrate the tool is created by the converter. As the vibrations are propagated through the acoustical tool, a harmonic resonance is established consisting of nodes and antinodes. This action results in a resonant wave being transferred through the tooling (Figure 2.10). The efficiency of the resonant wave transfer depends on the natural resonant frequency of the horn and is determined by two factors:

The speed of sound through the material.

The geometric shape of the object.

Figure 2.10 Harmonic Resonance on Ultrasonic Tooling.

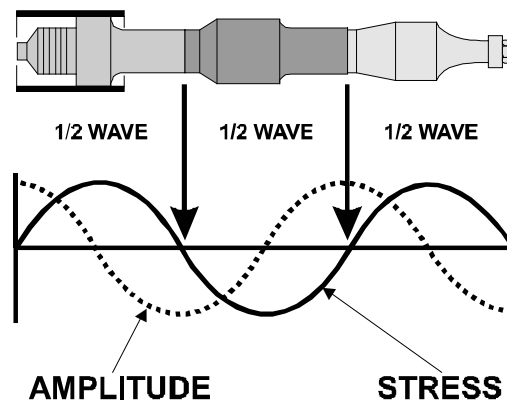

2.5.10 Avoiding An Overload Condition

It is possible to increase the Amplitude and or the Pressure to a point where the power available is not adequate to initiate or maintain vibration under the given mechanical load. At this point, the power supply will stall resulting in an Overload condition. Electronic circuits in the system will protect the power supply if this condition exists.

2.5.11 Welding To Time

In specific applications, 'Welding To Time' may be desired. As previously mentioned, there are three primary variables that interact; they are:

- **Time:** The duration of applied ultrasonic vibration
- **Amplitude:** The longitudinal displacement of the vibration
- **Force:** The compressive force applied perpendicular (normal) to the direction of vibration

Generally, welding for a specific time will produce acceptable results when:

- The equipment is installed on an automated production line and each station must complete its process within a certain time limit
- Very small low energy welds on clean components are being made

2.5.12 Welding Temperature

Ultrasonic welding produces a localized temperature rise from the combined effects of elastic hysteresis, interfacial slip and plastic deformation. The weld interfaces reach approximately 1/3 the temperatures needed to melt the metals. Since the temperature does not reach the melting point of the material, the physical properties of the welded material are preserved. As the ultrasonic welding process is an exothermic reaction, as welding time increases so does weld temperature.

2.6 Terminology

Actuator: A mechanical device which houses the converter/booster/horn (stack) assembly in a rigid mounting and is utilized to move the stack up or down. This allows for precise control of welding pressure while delivering mechanical vibrations from the ultrasonic stack to the work piece(s).

After Burst: A short duration (burst) of ultrasonic energy that begins after the weld is complete and at 1mm from the final height reading. Used when the splice nugget is sticking to the tooling.

Amplitude: Amplitude is the peak-to-peak displacement of mechanical motion as measured at the face of the horn tip. Amplitude is measured either in thousandths of an inch or in microns (e.g. a standard 40 kHz Converter produces approximately .0004" or 10 microns of amplitude), Inches x 25.4 = microns. -- This is adjustable depending on system frequency and application tooling.

Anti-Node: The anti-node is the area of the horn and booster that exhibits maximum longitudinal displacement and where the internal dynamic forces are equal to zero. This area is at the face and back surface on half-wave technology.

Anvil: A device specially designed to grip the lower component and hold it stationary against the energy of vibration(s) which allows a weld to be created.

BBR: Nonvolatile random access memory (battery back-up random access memory). Equipped with long life built in batteries, this memory area preserves weld parameters and menu settings when the system is powered off. (Also known as BRAM.)

Booster: The central component of an ultrasonic stack assembly. A device which transfers mechanical energy from the Converter to the ultrasonic horn. The booster will, depending on design, increase, decrease, or maintain the specific amplitude as received from the converter.

Calibration: The process of adjusting a device to a known position for purposes of inspection and/or monitoring position, direction, speed, and/or velocity.

Consumable Spare Tooling: The tooling portion of the ultrasonic system that wears and requires replacement due to production use. This includes but is not limited to ultrasonic horns, replaceable tips, anvil, and positioning mask. A Spare Tooling Specification Sheet is included within the Actuator Operation Manual to document the spare tooling for a specific metal welding application.

Controller: The portion of the welding system that provides specific settings & instruction(s) to the overall welding system.

Converter: A device which utilizes a PZT (lead-zirconate-titanate) electrostrictive element to change high frequency electrical energy into high frequency mechanical energy.

Counter: A programmable device used to monitor system cycles and alert personnel when specific conditions are met.

Data: Any representation(s) of instructions, characters, information, or analog quantities to which meaning may be assigned.

Default: A chosen system setting or parameter in which the system does not require external data input. In some cases the default value will be changed based upon equipment use.

Dynamic Spring: An, adjustable, energy storage mechanism (shock absorber) which allows for stack follow through upon engagement of application tooling with the work pieces to be welded.

Energy: Energy is the area beneath the ultrasonic power curve and is calculated in joules, (Watts X Seconds = Joules). When the ultrasonic welding system is setup in the "Weld In

Energy" mode the system will deliver the amount of energy as programmed. **Note:** The maximum (default) time allowed for delivering ultrasonic energy is five (5) seconds.

Energy Mode: A welding method in which the ultrasonic power supply is active until the required amount of energy is delivered (see ENERGY).

Fixture: A device for positioning and or holding a component for assembly.

Force: The amount of mechanical pressure that is used to deliver (bring down) the mechanical actuator. This programmed force is also called TRIGGER FORCE and is used to engage the knurl pattern into the component part(s) prior to the initiation of ultrasonic energy.

Frequency: The number of complete oscillations per second expressed in Hertz (Hz) or kilohertz (1 kilohertz = 1000 Hz). Typically 20 kHz or 40 kHz.

Gain: The ratio of the amplitude of motion produced by the Converter and delivered by the horn is called the gain. It is determined by the difference in mass on either side of the nodal point.

Gathering Block: A specially designed mechanical device used to sweep across the face of the Tip to collect the wire strands, and to form the width of the compression chamber.

Height: A value, in millimeters (mm), as registered by a linear encoder upon completion of an ultrasonic welding cycle. -- Programmable, in millimeters, with Upper Control Limit & Lower Control Limit.

Height Encoder: A device utilized to monitor position, direction, speed, and/or velocity.

Horn: An acoustically designed metal tool that delivers mechanical energy from the converter/booster into the work piece. Most applications utilize half wave technology.

Hold Time: The amount of time after delivery of ultrasonic energy until the stack tooling begins to retract from the component material(s).

Joint: The area where the surfaces are welded together.

Linear Height Encoder: See Height Encoder.

Loading Meter: A meter which indicates the power drawn from the ultrasonic power supply.

Maintenance Counter: Used to alert production personnel of the need to review/inspect application tooling and/or the ultrasonic system for preventive maintenance purposes. (See Counters).

Mode: The method of operating the system (also see WELDING MODE).

Node: The node is the area of the horn, (and booster), that exhibits no longitudinal displacement and where the internal dynamic forces are at the maximum. This area is in the center location on half-wave technology.

Parameter(s): Programmable units used to control and or monitor the ultrasonic process. --Include but not limited to ENERGY, FORCE, PRESSURE, AMPLITUDE.

Parts Counter: Used to monitor system cycles and alert personnel when specific conditions are met. (See Counters).

Peak Power: Peak power is the maximum amount of power in watts that was required to keep the ultrasonic stack in motion during the weld cycle.

Power: Power, measured in watts, is a function of pressure and amplitude. The amount of power, (watts) required to keep the ultrasonic stack in motion is monitored and used to develop a power curve. This power curve is used to calculate the amount of energy delivered/ dissipated, (Watts = Joules/Time). The power as displayed on the control box is peak power.

Power Supply (Ultrasonic): An electronic device that converts 50/60 cycle electrical current into 40 kHz, (40,000) or 20 kHz, (20,000) cycles per second high frequency electrical energy.

Power Supply Overload (Ultrasonic): The point or limit at which the amount of power in watts, required to keep the ultrasonic stack in motion, exceeds the available power from the power supply. The system will go into an overload condition in order to prevent system damage.

Pre-Burst: A short duration (burst) of ultrasonic energy that begins after the Squeeze Time and before capturing the Pre-Height. Used when welding magnet wire. It helps to break up the insulation around the copper, and provide a small cooling period before the weld takes place.

Pre-Height: A pre-sonic inspection display, in millimeters (mm), as registered by a linear encoder prior to initiation of the ultrasonic welding cycle. -- Programmable, in millimeters, with Upper Control Limit & Lower Control Limit.

Presets: Welding parameters stored in the controller memory.

Pressure: The amount of mechanical pressure supplied to the ultrasonic stack assembly while delivering ultrasonic energy to the components.

Quality Widows & Limits: Programmable values used by the system to compare actual process data. Actual process data must be within limits or an alarm be issued.

Quick After Burst: Once this option is enabled, the after burst needs to be implemented immediately after each weld cycle finished without any time delay or condition judgment.

Squeeze Time: The amount of time after the ultrasonic tooling engages the component(s) and before delivery of ultrasonic energy. -- Adjustable from 0 - 2 seconds.

Stress: Stress is the amount of dynamic force per cross sectional area.

Time: Time is the duration of the ultrasonic, mechanical, activity. Time is a component used to calculate the amount of ultrasonic energy delivered during a weld cycle, (Time = Joules/Watts).

Tip: Device specially designed to grip the upper component, to be welded, and to direct the ultrasonic energy into the work piece, (Also Horn Tip & Replaceable Horn Tip).

Tip Nut: Device specially designed to securely clamp a replaceable tip onto the horn.

Trigger Force: See Force.

Tuning: Adjusting to optimize power supply performance according to resonance frequency, especially with regard to the horn and converter.

Velocity: The rate of motion at a specific time [velocity = distance time] Also referred to as speed.

Width Encoder: A device utilized to monitor the position of the Gathering Block.

Chapter 3: Shipping and Handling

3.1	Shipping and Handling	28
3.2	Receiving	29
3.3	Unpacking	30
3.4	Returning Equipment	31

3.1 Shipping and Handling

CAUTION	High Voltage Hazard
	<p>The Touchscreen Controller's internal components are sensitive to static discharge. Many components can be harmed if the unit is dropped, shipped under improper conditions or otherwise mishandled.</p>

3.1.1 Environmental Specifications

The Touchscreen Controller is an electronic unit that converts line voltage to ultrasonic energy and controls user input for regulating the weld process. Its internal components are sensitive to static discharge, and many of its components can be harmed if the unit is dropped, shipped under improper conditions, or otherwise mishandled.

The following environmental guidelines should be respected when shipping the Touchscreen Controller:

Table 3.1 Environmental Requirements

Environment	Range
Storage / Shipping Temperature	-13° F to +131° F (-25° C to +55° C)
Humidity	30% to 95%* non condensing

*Above 40° C the humidity drops to 90%

3.2 Receiving

The Touchscreen Controller is a sensitive electronic device. Many of its components can be harmed if the unit is dropped or otherwise mishandled.

CAUTION	Heavy Object
	<p>The Actuator and the Touchscreen Controller are heavy. Handling, unpacking, and installation might require assistance or the use of a lifting device.</p>

Scope of Delivery

Branson units are carefully checked and packed before dispatch. It is recommended, however, that you follow the inspection procedure below after delivery.

To inspect the Touchscreen Controller when it is delivered, take the following steps:

Table 3.2 Inspection procedure after delivery

Step	Action
1	Verify that all parts are complete according to the packing slip.
2	Check the packing and the unit for damage (visual inspection).
3	Report any damage claims to your carrier immediately.
4	Determine if any component has become loose during shipping and, if necessary, tighten screws.

NOTICE	
	<p>If the goods delivered have been damaged during shipping, please contact the forwarding agent immediately. Retain packing material (for possible inspection or for sending back the unit).</p>

3.3 Unpacking

The Touchscreen Controller is fully assembled. It is shipped in a sturdy cardboard box. Some additional items are shipped in the box with the Touchscreen Controller.

When unpacking the Touchscreen Controller, take the following steps:

Table 3.3 Unpacking

Step	Action
1	Unpack the Touchscreen Controller as soon as it arrives. Save the packing material.
2	Inspect the unit for signs of damage.
3	Remove the cover of the Touchscreen Controller (see 6.2 Parts Replacement) to check if any components became loose during shipping.
4	Store or ship the Touchscreen Controller only within a temperature range of -13° F to +131° F (-25° C to +55° C).

NOTICE	
	<p>If damage has occurred, notify the shipping company immediately. Retain packing materials for inspection.</p>

3.4 Returning Equipment

If you are returning equipment to Branson, please call your Branson Representative or Customer Service to receive approval to return goods to Branson.

If you are returning equipment for repair refer to [Chapter 1: Safety and Support](#) of this manual, for appropriate procedure.



Chapter 4: Technical Specifications

4.1	Environmental Requirements	34
4.2	Electrical Requirements	35
4.3	Pneumatic Requirements	36

4.1 Environmental Requirements

The Touchscreen Controller has the following Environmental Requirements:

Table 4.1 Environmental Requirements

Environmental Concern	Controller/Power Supply
Ambient Operating Temperature	+41° F to +122° F (+5° C to +50° C)
Storage / Shipping Temperature	-13° F to +131° F (-25° C to +55° C*)
Humidity	30% to 95%**non condensing
Operating Altitude	1000 m (3280 ft)
IP Rating	2X

*70° C for 24 hours.

**Above 40° C the humidity drops to 90%.

4.2 Electrical Requirements

The following tables list input voltages, current requirements, and fuse requirements for the Touchscreen Controller Welding System, and includes power required when it is used with Branson Metal Welding Actuators.

Table 4.2 Electrical Input Operating Voltages

Power Supply Rating	Nominal Input Operating Voltage, +/-10%
40 kHz / 800W	200-230 V, 50/60 Hz, Single Phase
30 kHz / 1500 W	200-230 V, 50/60 Hz, Single Phase
20 kHz / 3300W	200-230 V, 50/60 Hz, Single Phase
20 kHz / 4000 W	200-230 V, 50/60 Hz, Single Phase

Table 4.3 Input Current and Fuse Requirements

Model	Power	Current Rating
For 20 kHz Models	3300 W 200V - 230V	21 Amp Max. @ 200V / 20 Amp fuse
	4000 W 200V - 230V	25 Amp Max. @ 200V / 25 Amp fuse
For 30 kHz Models	1500 W 200V - 230V	10 Amp Max. @ 200V / 10 Amp fuse
For 40 kHz Models	800 W 200V - 230V	5 Amp Max. @ 200V / 8 Amp fuse

4.3 Pneumatic Requirements

The factory compressed air supply must be “clean (to a 5 micron level), dry and unlubricated” air with a regulated maximum pressure of 80 psig (5.5 bar).

Chapter 5: Operation

5.1	Before Operating the Unit	38
5.2	Run Screen	39
5.3	Menu Options Screen	41
5.4	Weld Settings Screen	43
5.5	Weld Mode Screen	45
5.6	Advanced Weld Settings Screen	47
5.7	Preset Menu Screen	48
5.8	Preset Name Screen	49
5.9	Preset Library Screen	50
5.10	Maintenance Menu Screen	51
5.11	Height Calibration Screen	53
5.12	Sonic Generator Screen	54
5.13	Sending Screen	55
5.14	Maintenance Counters and Limits Screen	56
5.15	Weld Limits Screen	57
5.16	Sequence Menu Screen	58
5.17	Sequence Name and Edit Screen	59
5.18	Sequence Steps Screen	60
5.19	Sequence Library Screen	61
5.20	Height Adjustment Screen	62
5.21	System Configuration Screen	63
5.22	Cooling Screen	64
5.23	Teach Mode Setup Screen	65
5.24	System Configuration Screen (Next)	67
5.25	Actuator Selection Screen	68
5.26	Password Changing Screen	69
5.27	Low Air Alarm Screen	70
5.28	System Configuration Screen (Next, Next)	71
5.29	Transducer Configuration Screen	72
5.30	Sequence Error Screen	73
5.31	Gateway Feature	74
5.32	Diagnostic Screen	75
5.33	Serial Port Diagnostic Screen	76
5.34	Cycles Screen	77
5.35	Typical Keypad Entry Screen	78
5.36	Advanced Function Switch Select	79
5.37	Saving/Transferring Preset and Sequence Information	80
5.38	Safety Circuit Alarms	82

5.1 Before Operating the Unit

Before attempting to operate the controller, make sure you have reviewed the entire manual and have an understanding of safety procedures. Check that connections between the controller and actuator are as shown in the Hookup Diagram provided in Special Information Instruction Set. The power button on the front of the system may then be used to turn the system on.

WARNING	High Voltage Hazard
	<p>High voltage might be present in the Branson Touchscreen Controller (Touchscreen). When setting up and operating the welding system, observe the potential hazards listed below.</p>

- Do not operate the Touchscreen Controller with the cover removed
- To prevent the possibility of electric shock, always plug the Touchscreen Controller into a grounded power source
- Do not cycle the welding system if either the RF cable or the converter is disconnected. High voltage could be present at open power connections
- Ensure power switch is in the OFF position before making or breaking any electrical or pneumatic connections to the Touchscreen Controller and/or Welder
- Do not touch Ultrasonic Horn during or immediately following the welding cycle. Vibrations and heat can burn skin
- When operating the controller keep clear of the actuator moving parts
- If power is removed from the system while the controller is on, it will be necessary to press the power button to its off position and then once again to its on position in order to restore power to the system

Interactive user screens supply a means of function selection and data entry for setting up the controller. The following pages provide illustrations, function descriptions and screen navigation instructions.

In the event of a system fault or an improper keyed entry, the controller will provide an instructional prompt screen in order to remedy the condition.

Controller User Screen Hierarchy

A drawing included in the Special information Instruction Set provides an overview of the controller user screens and functions shown in tree structure. It serves as a useful tool for navigating the command structure of the controller.

5.2 Run Screen

Figure 5.1 Run Screen

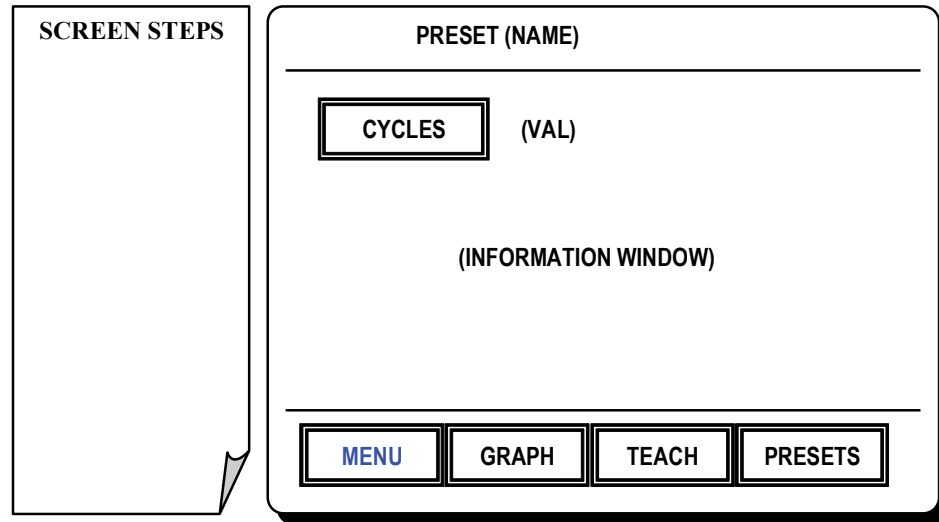

NOTICE	
	<p>An image similar to the above will accompany the controller instructions in this section. The image on the right side resembles the controller touchscreen display. The left sidebar shows the screen steps required to arrive at the current display. If you are viewing the manual on a computer you may click on the blue links which will emulate many of the touchscreen operations.</p>

Run Screen

This is the Run Screen. When you turn on your Controller it will start at this screen. Navigating from this menu will allow setup and configuration of the unit for your application.

Press one of the following options for this screen:

MENU

To go to the Menu Options which allows access to the settings and features of the controller. See [5.3 Menu Options Screen](#).

GRAPH/ DATA TOGGLE

To alternately display:

Power/ time graph of previous weld.

Current weld settings and feedback from previous weld.

TEACH TOGGLE

To accept teach samples when TEACH is shown highlighted. Used in standard mode the PRESET button will be replaced by an ACCEPT button which is pressed to add the previous weld data to the sample set. For more on Teach Mode see [5.23 Teach Mode Setup Screen](#).

PRESETS

To retrieve a preset or save over an existing one stored in the controller preset library. For more on Presets see [5.7 Preset Menu Screen](#).

CYCLES

To reset the continuous cycle counter provided for user reference.

5.3 Menu Options Screen

Figure 5.2 Menu Options screen

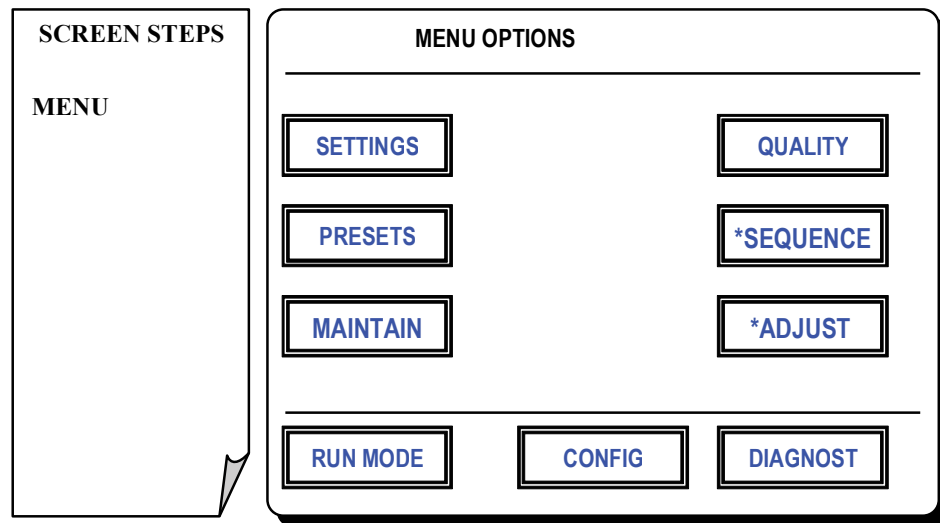

Menu Options Screen

This screen allows access to the features of the controller. Features are divided in to related groups. Access to Configuration and Diagnostics are protected by a user changeable password. The password is initially set to 2677, the last four digits of Branson Metal Welding's phone number.

Press one of the following options for this screen:

SETTINGS

To change individual weld parameters which are the basic elements required to make a weld. See [5.4 Weld Settings Screen](#).

PRESETS

To name, save and recall specific weld parameter settings which may be stored in the controller's non volatile memory. See [5.7 Preset Menu Screen](#).

MAINTAIN

To allow adjustment and on demand control of the various motion devices in the weld actuator. Also allows access to maintenance counters which monitor tool life and sending data functions. See [5.10 Maintenance Menu Screen](#).

QUALITY

To allow setting min and max parameters for weld time, power, preheight and height. See [5.15 Weld Limits Screen](#).

SEQUENCE*

To name, save and recall sequences which may be stored in the controller's non volatile memory. A sequence is a series of grouped presets which are to be executed in a particular quantity and order. See [5.16 Sequence Menu Screen](#).

*Not available on Ultrasplice 40 & ST 40 actuators.

ADJUST*

To set weld height adjustment based on the measurements taken from the previous weld. See [5.20 Height Adjustment Screen](#).

*Available only on Ultraweld 20, Ultraweld 40, MTS 20, & ST 40 actuators equipped with a height encoder which is set to on.

CONFIGURATION

To access configuration features of the controller. These include units and language selection as well as various other operational settings. See [5.21 System Configuration Screen](#).

DIAGNOSTIC

To make changes at the operating system level. These include initialization, serial port configuration and touch panel calibration. See [5.32 Diagnostic Screen](#).

RUN MODE

To return to Run Mode. See [5.2 Run Screen](#).

5.4 Weld Settings Screen

Figure 5.3 Weld Settings screen

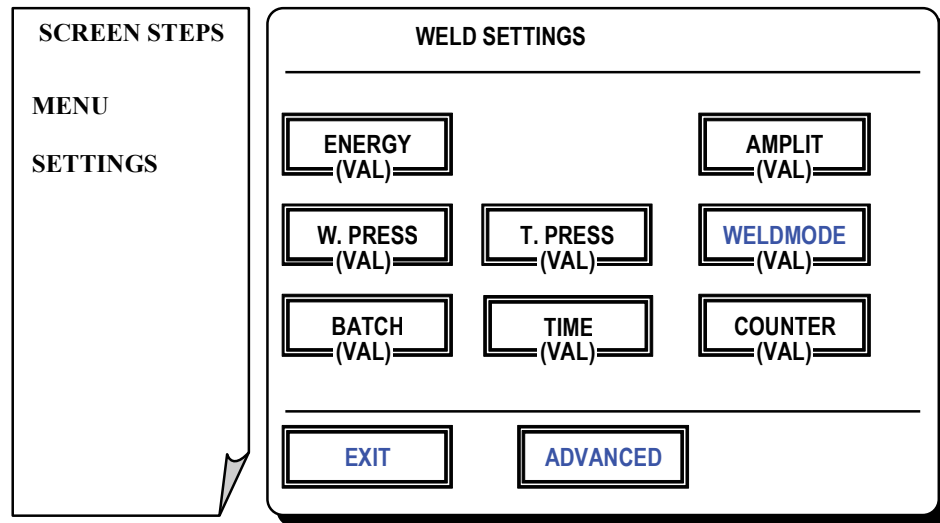

Weld Settings Screen

From this screen you may change individual weld parameters which are the basic elements required to make a weld.

Press one of the following options for this screen:

ENERGY

To change the amount of energy (joules) delivered for each weld. See [5.35 Typical Keypad Entry Screen](#).

WELD PRESSURE

To change the clamping pressure delivered by the actuator while the weld is taking place. See [5.35 Typical Keypad Entry Screen](#).

BATCH

To set a batch count quantity which will display from the Run Screen in data mode. See [5.35 Typical Keypad Entry Screen](#).

TRIGGER PRESSURE

To change the pressure used to engage the knurl pattern into the component parts prior to initiation of ultrasonic energy. See [5.35 Typical Keypad Entry Screen](#).

TIME

To change the time duration of ultrasonic energy applied for each weld cycle. See [5.35 Typical Keypad Entry Screen](#).

Available only when Weld Mode is set to Time. See [5.5 Weld Mode Screen](#).

AMPLITUDE

To change amplitude which is measured in microns. If an amplitude stepping mode has been selected on the Weld Mode screen, you will be able to enter Amp-A, Amp-B, and a Step Point. Amplitude is the displacement of mechanical motion of the horn. See [5.35 Typical Keypad Entry Screen](#).

WELDMODE

To select the determining criteria for cut off of the ultrasonic energy. See [5.5 Weld Mode Screen](#).

COUNTER

To reset the batch counter.

ADVANCED

To enter selections pertaining to afterburst, squeeze and hold time. See [5.6 Advanced Weld Settings Screen](#).

EXIT

To return to Menu Options. See [5.3 Menu Options Screen](#).

5.5 Weld Mode Screen

Figure 5.4 Weld Mode screen

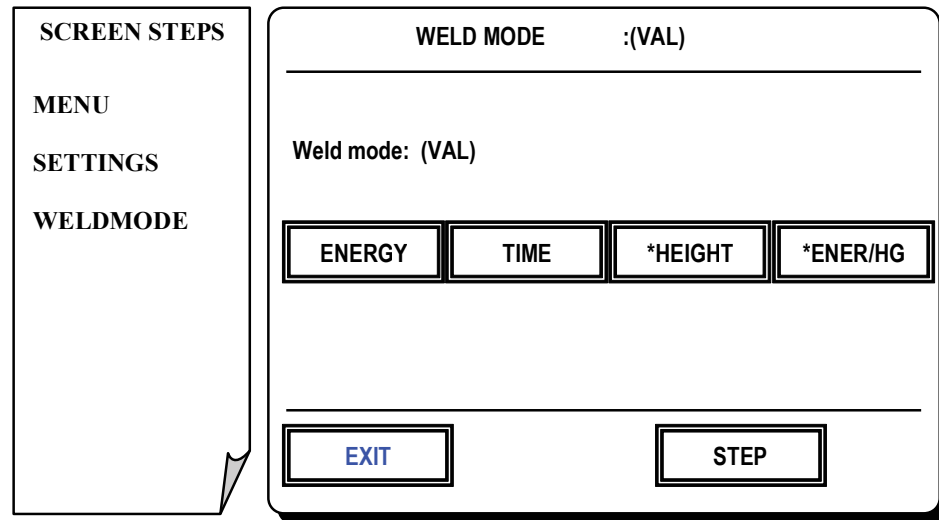

Weld Mode Screen

From this screen the weld mode may be selected. The weld mode dictates which weld setting variable will serve as the cutoff limit for the delivery of ultrasonic energy during each weld cycle.

Press one of the following options for this screen:

ENERGY

To weld in energy mode. The system delivers ultrasonic energy until a predetermined amount of energy (joules) is dissipated.

TIME

To weld in time mode. The system delivers ultrasonic energy for a predetermined amount of time (sec).

HEIGHT*

To weld in height mode. The system delivers ultrasonic energy until the tooling reaches a predetermined height (mm).

*Available only on Ultraweld 20, Ultraweld 40, MTS 20, & ST 40 actuators equipped with a height encoder which is set to on.

ENERGY W/HEIGHT COMPENSATION*

To weld in energy with height compensation mode. The system first delivers the predetermined amount of energy. If after the energy is delivered the welded part size does not fall within the height (mm) window, the system will deliver as required up to 300% more energy in order to achieve a mid window weld height.

*Available only on Ultraweld 20, Ultraweld 40, MTS 20, & ST 40 actuators equipped with a height encoder which is set to on.

STEP

To select the amplitude stepping mode. For information on entering the start amplitude, the step amplitude, and a stepping point see "Amplitude" under [5.4 Weld Settings Screen](#).

For information on Amplitude Stepping, see [2.5.8 Amplitude Stepping](#).

EXIT

To return to Weld Settings. See [5.4 Weld Settings Screen](#).

5.6 Advanced Weld Settings Screen

Figure 5.5 Advanced Weld Settings screen

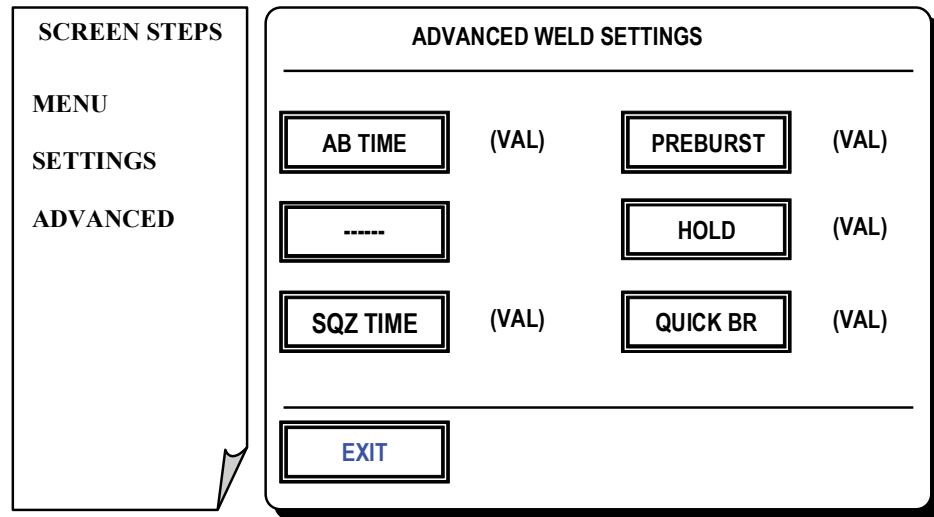

Advanced Weld Settings

This screen allows access to the advanced options features defined below. These values will normally reflect the default settings made in Configuration mode. Values set from this screen will only effect the preset currently in use.

Press one of the following options for this screen:

AFTERBURST TIME

To change the amount of time (sec) of a short burst of ultrasonic energy that begins after the ultrasonic welding cycle. See [5.35 Typical Keypad Entry Screen](#).

AFTERBURST DELAY

To change the amount of time (sec) between the completion of the ultrasonic weld cycle and the start of the afterburst. See [5.35 Typical Keypad Entry Screen](#).

SQUEEZE TIME

To change the amount of time (sec) between when the horn engages the component(s) and when the delivery of ultrasonic energy occurs. See [5.35 Typical Keypad Entry Screen](#).

PREBURST

To change the amount of time (sec) of a short burst of ultrasonic energy that begins after the squeeze time and before capturing the Pre-Height. Used when welding magnet wire. It helps to break up the insulation around the copper, and provide a small cooling period before the weld takes place. See [5.35 Typical Keypad Entry Screen](#).

HOLD

To change the amount of time (sec) the components remain held under weld pressure after the delivery of ultrasonic energy. See [5.35 Typical Keypad Entry Screen](#).

QUICK AFTER BURST

To enable/disable the Quick After Burst function.

EXIT

To return to Weld Settings. See [5.4 Weld Settings Screen](#).

5.7 Preset Menu Screen

Figure 5.6 Preset Menu screen

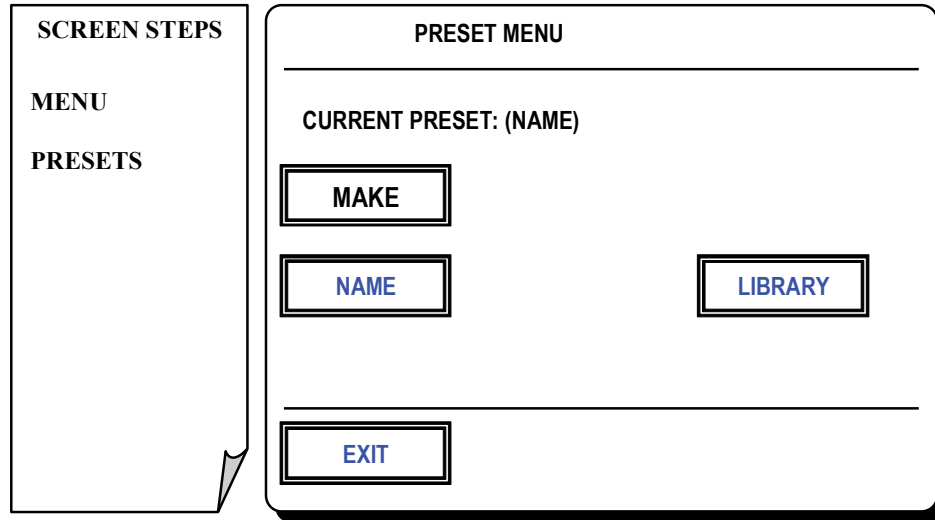

Preset Menu Screen

The controller allows for the storage of weld settings. The stored information is known as a preset. When a name is created and saved in the library, presets may then be saved under that name.

Press one of the following options for this screen:

MAKE NEW

To clear the current preset name in use. Advanced settings will default to those set under Configuration.

NAME

To create or edit a Preset Name. See [5.8 Preset Name Screen](#).

LIBRARY

To save a preset by name for later recall. See [5.9 Preset Library Screen](#).

EXIT

To return to Menu Options. See [5.3 Menu Options Screen](#).

5.8 Preset Name Screen

Figure 5.7 Preset Name screen

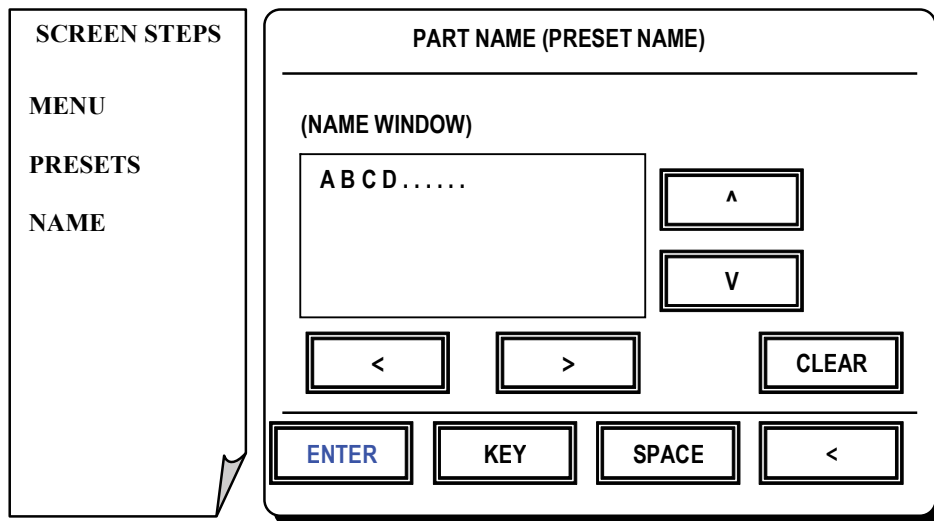

Preset Name Screen

Names are created from this screen. The reason for creating a name is to associate it with particular group of weld settings and then store it in the controller library. A preset name may contain up to 20 characters.

Press one of the following options for this screen:

UP, DOWN, LEFT or RIGHT ARROWS

To navigate cursor over the desired character in the selection box.

KEY

To add the character in the name window.

SPACE

To add spaces in name window.

ARROW (lower right hand of screen)

To backspace one character.

CLEAR

To erase all characters in the name window.

ENTER

To return to Preset Menu when you are satisfied with the name you have created. See [5.7 Preset Menu Screen](#).

NOTICE	
	<p>The name will not be saved until it is stored in the library. See 5.9 Preset Library Screen.</p>

5.9 Preset Library Screen

Figure 5.8 Preset Library screen

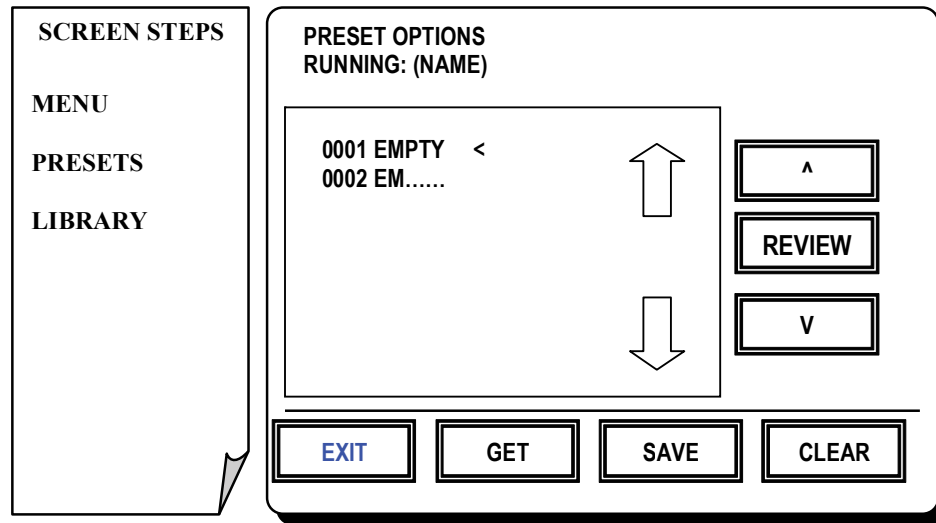

Preset Library Screen

When presets have been named and configured they must be stored in the library memory in order to retrieve them at a later date. Previously stored presets are also retrieved from this screen. The storage registers are shown mid screen starting with the number 0001 EMPTY. The preset that has been created or is in use is shown at the top of the screen. The library may store up to 1000 presets.

Press one of the following options for this screen:

UP or DOWN ARROWS

(Inside the storage register display window). To scan the library a page at a time.

UP or DOWN ARROWS

(Outside the storage register display window). To position the selection cursor next to the storage register you wish to fill, edit or retrieve from.

REVIEW

To view the weld settings associated with the register you have selected.

GET

To retrieve the preset into current memory.

SAVE

To retain the preset information in a selected register.

CLEAR

To erase information stored in a register.

EXIT

To return to the Preset Menu. See [5.7 Preset Menu Screen](#).

5.10 Maintenance Menu Screen

Figure 5.9 Maintenance Menu screen

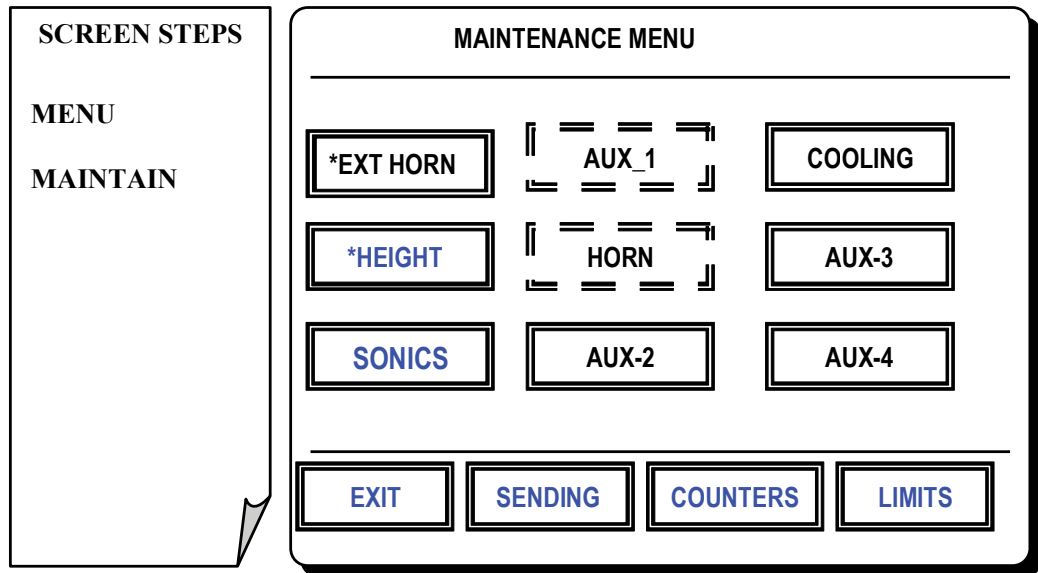

Maintenance Menu Screen

The maintenance screen allows adjustment and on demand control of motion devices that are used in the weld actuator. This screen also allows access to sending data functions, maintenance counters and limit settings.

The level 2 password must be entered to access this menu. Default password is 2677.

Press one of the following options for this screen:

*EXT HORN

To toggle the horn between up and down positions triggered by an external signal.

Use IN4 pin of the control cable for this function. When the EXT HORN signal is active, the HORN button will be highlighted.

*Make sure the L20 Actuator is selected to enable this function.

HEIGHT*

To calibrate the horn to anvil clearance. See [5.11 Height Calibration Screen](#).

*Available only on Ultraweld 20, Ultraweld 40, MTS 20, & ST 40 actuators equipped with a height encoder which is set to on.

SONICS

To allow on demand control of ultrasonic weld energy and calibrate amplitude. See [5.12 Sonic Generator Screen](#).

AUX_1 / GATHER

To toggle auxiliary actuator used on special systems (Ultraweld 20, Ultraweld 40, MTS 20, and ST 40).

To toggle the gather between open and closed positions (Gun 40 and MTS 20).

HORN / ANVIL

To toggle the horn between up and down positions. (Ultraweld 20, Ultraweld 40, and ST 40).

To toggle the anvil between up and down positions (Gun 40 and MTS 20).

AUX_2, AUX_3, AUX_4

To toggle auxiliary actuator used on special systems.

COOLING

To toggle the cooling air control solenoid on and off.

SENDING

To initialize and send the RS232 port used for recording weld information. See [5.13 Sending Screen](#).

COUNTERS

To set individual maintenance counters for critical parts on the actuator. See [5.14 Maintenance Counters and Limits Screen](#).

LIMITS

To set individual maintenance limits for critical parts on the actuator. See [5.14 Maintenance Counters and Limits Screen](#).

EXIT

To return to Menu Options. See [5.3 Menu Options Screen](#).

5.11 Height Calibration Screen

Figure 5.10 Height Calibration screen

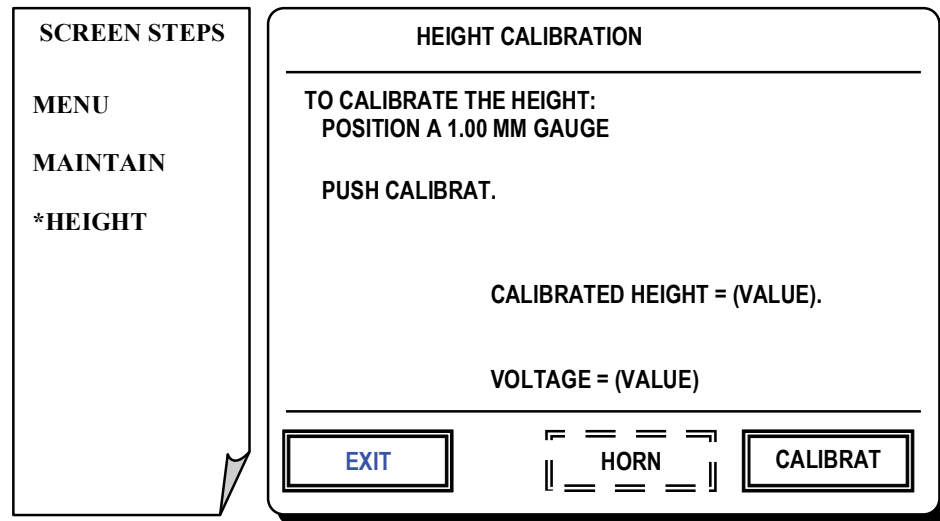

Height Calibration Screen

This screen is for height (horn to anvil) calibration. The instructions on the screen explain the procedure for calibrating.

*Available only on Ultraweld 20, Ultraweld 40, MTS 20, & ST 40 actuators equipped with a height encoder which is set to on.

Press one of the following options for this screen:

HORN/ANVIL

To open and close horn against anvil.

CALIBRATE

To calibrate height

EXIT

To return to Maintenance Menu. See [5.10 Maintenance Menu Screen](#).

5.12 Sonic Generator Screen

Figure 5.11 Sonic Generator screen

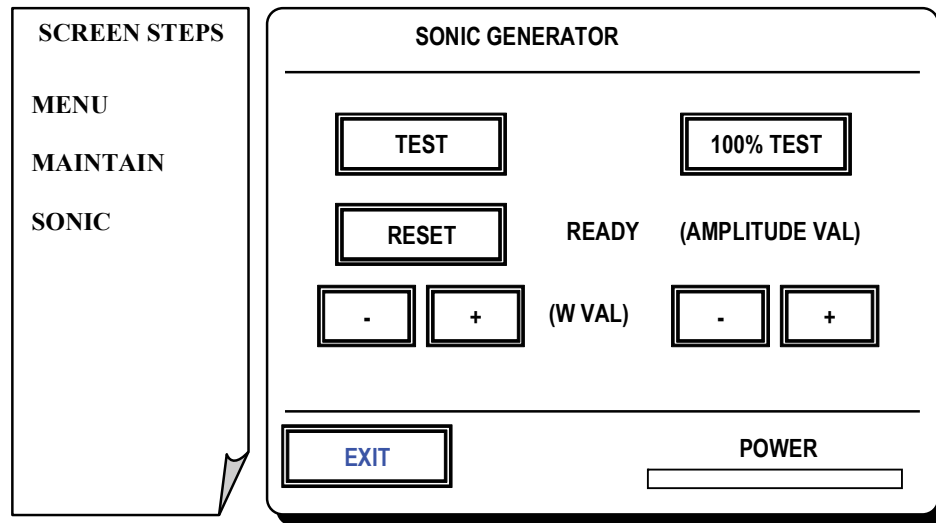

Sonic Generator Screen

This screen allows on demand control of ultrasonic weld energy and calibration of amplitude.

Amplitude calibration requires a dial indicator to be temporarily mounted in line with and in front of the horn usually on a magnetic base. The 100% test button is held and gage reading is viewed.

The gage reading $\times 2 =$ total amplitude, this is the value to be entered for the amplitude value when calibrating.

Press one of the following options for this screen:

TEST

To fire ultrasonic energy at the current amplitude setting.

RESET

To reset the controller if a weld overload should occur.

PLUS or MINUS (W)

Is set by Branson for a given actuator and is not changed. Generally the setting for 20 kHz actuators is 3300 W and the setting for 40 kHz actuators is 800W.

100% TEST

To fire ultrasonic energy at 100% amplitude. This is used when calibrating amplitude.

PLUS OR MINUS (MICRONS)

To set the amplitude value based on the indicator reading. See above.

POWER

Power rate is displayed in real-time.

EXIT

To return to Maintenance Menu. See [5.10 Maintenance Menu Screen](#).

5.13 Sending Screen

Figure 5.12 Sending Screen

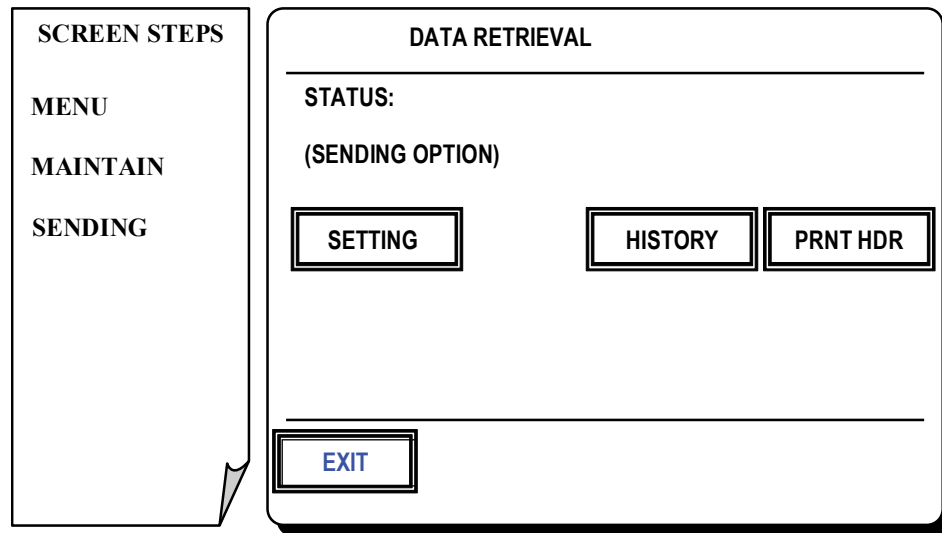

Sending Screen

This screen is for setup and test the RS232 port used for recording weld information.

Press one of the following options for this screen:

SETTING

To select the sending options which include:

- Sending off
- Send each weld
- Send on alarm

HISTORY

To send weld history information for previous welds. Send up to 128 welds.

PRNT HDR/NO HDR

To toggle header on and off.

EXIT

To return to Maintenance Menu. See [5.10 Maintenance Menu Screen](#).

5.14 Maintenance Counters and Limits Screen

Figure 5.13 Maintenance Counters and Limits screen

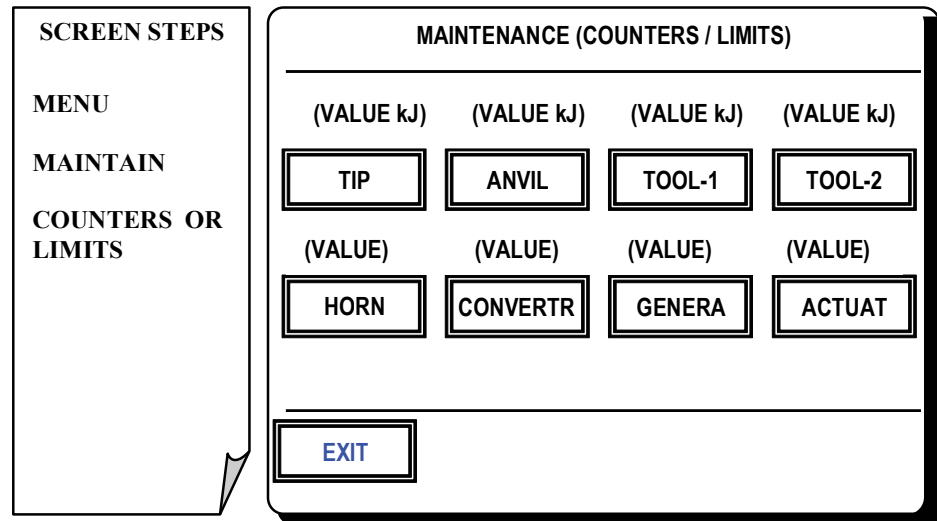

Maintenance Counters and Limits Screen

Maintenance counters and limits are related. Both are set using the above screen. A maintenance counter will increment after each weld cycle up to the limit values set by the user. When a limit is exceeded the controller will issue a warning the next time it is turned on. Maintenance counters and limits may be reset at will. Any maintenance counter value which is less than its corresponding set limit value does not produce a warning on startup.

The top four values on the screen for tip, anvil, tool-1 and tool-2 are set in kilo joule units.

Example: if the energy weld setting in use is 1500 joules, a limit setting of 7500 kilo joules will produce about 5000 cycles before reaching its limit.

The tool-1 and tool-2 counters may be used to represent any special fixture tooling.

The bottom four values on the screen for horn, converter, generator (ultrasonic power supply), and actuator are set in number of cycles.

If a limit is set to 0 it will not yield a warning regardless of the maintenance count.

Press one of the following options for this screen:

ANY BUTTON

That you wish to set counter or limit values for. See [5.35 Typical Keypad Entry Screen](#).

EXIT

To return to Maintenance Menu. See [5.10 Maintenance Menu Screen](#).

5.15 Weld Limits Screen

Figure 5.14 Weld Limits screen

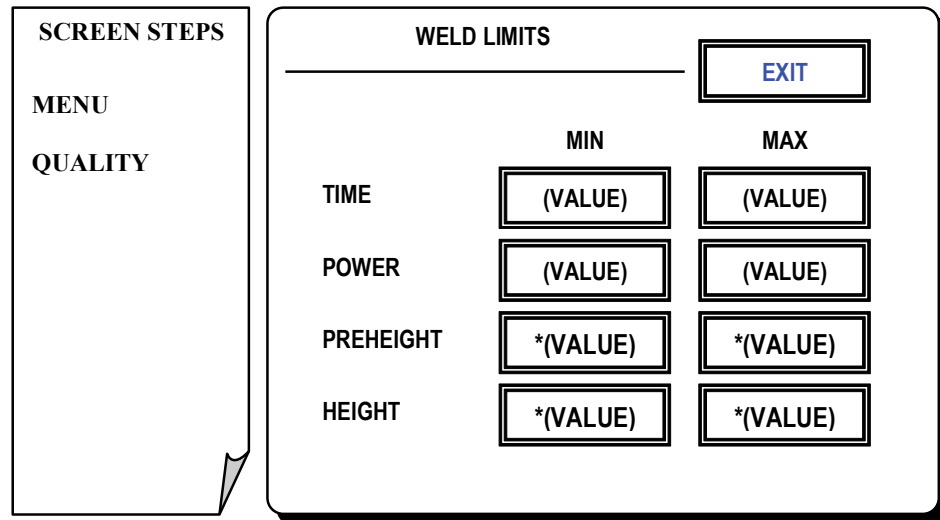

Weld Limits Screen

Weld limits assure that certain weld settings fall within a min/max range. This operating window assures the user of consistency between welds. If values fall outside these limits an alarm is given.

Press one of the following options for this screen:

TIME MIN or MAX

To set the min/max time (sec) that ultrasonic energy may be applied to a weld. See [5.35 Typical Keypad Entry Screen](#).

POWER MIN or MAX

To set the min/max power (watts) which may be applied to a weld. See [5.35 Typical Keypad Entry Screen](#).

PREHEIGHT MIN or MAX*

To set the min/max pre-height (mm). This is a pre sonic inspection reading from the height encoder prior to weld. See [5.35 Typical Keypad Entry Screen](#).

*Available only on Ultraweld 20, Ultraweld 40, MTS 20, & ST 40 actuators equipped with a height encoder which is set to on.

HEIGHT MIN or MAX*

To set the min/max height (mm). This is a post sonic inspection reading from the height encoder after welding. See [5.35 Typical Keypad Entry Screen](#).

*Available only on Ultraweld 20, Ultraweld 40, MTS 20, & ST 40 actuators equipped with a height encoder which is set to on.

EXIT

To return to Menu Options. See [5.3 Menu Options Screen](#).

5.16 Sequence Menu Screen

Figure 5.15 Sequence Menu screen

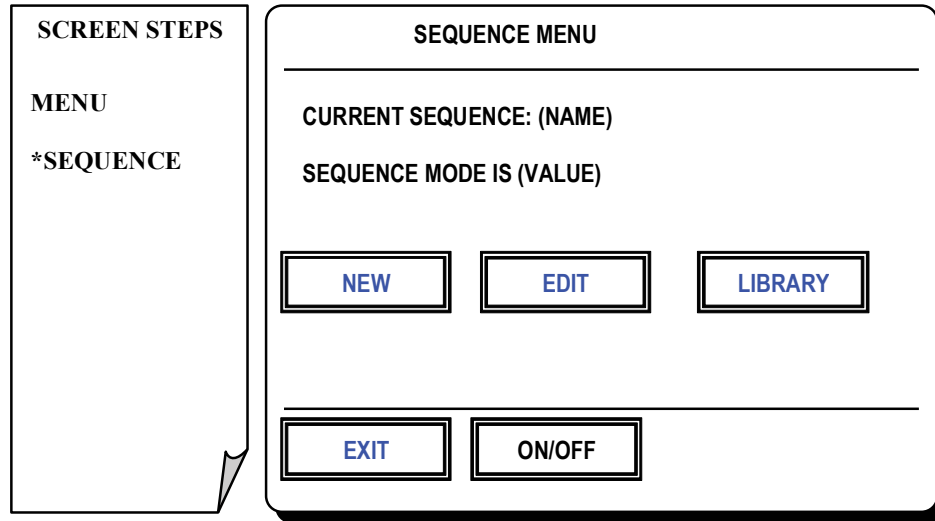

Sequence Menu Screen

A sequence is a series of grouped presets which are to be executed in a particular quantity and order. Sequences are constructed using existing presets which have been previously stored in the preset library. When the combination of presets and their desired cycle quantities have been constructed they may be saved into the sequence library for future recall.

*Not available on Ultrasplice 40 & ST 40 actuators.

Press one of the following options for this screen:

NEW

To create a new sequence name. See [Figure 5.16 Sequence Name and Edit screen](#).

EDIT

To edit an existing sequence name. See [Figure 5.16 Sequence Name and Edit screen](#).

LIBRARY

To access the sequence library. See [5.19 Sequence Library Screen](#).

ON/OFF

To toggle sequence mode on and off.

EXIT

To return to Menu Options. See [5.3 Menu Options Screen](#).

5.17 Sequence Name and Edit Screen

Figure 5.16 Sequence Name and Edit screen

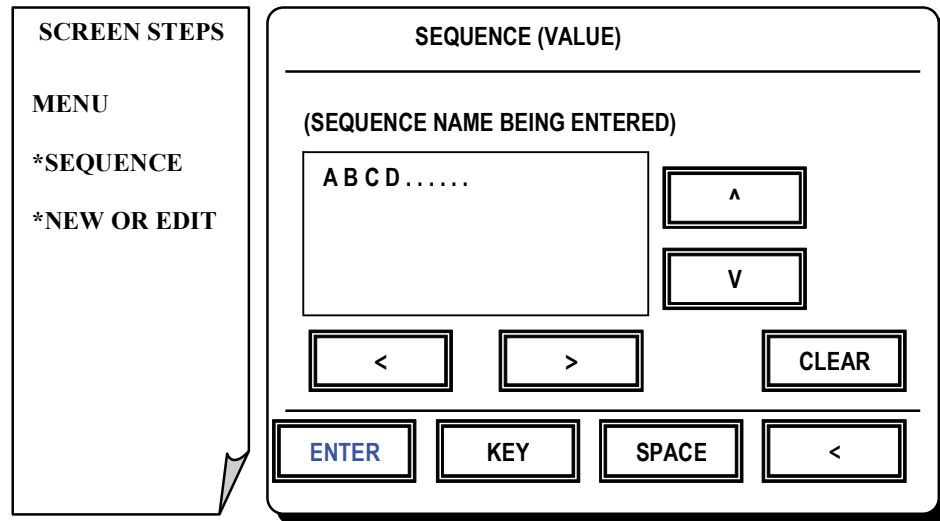

Sequence Name & Edit Screen*

Sequence names are created and edited from this screen. Once the name is created the user may choose the presets which make up the sequence. Up to 50 sequences may be stored.

*Not available on Ultraslice 40 & ST 40 actuators.

Press one of the following options for this screen:

UP, DOWN, LEFT or RIGHT ARROWS

To navigate cursor over the desired character in the selection box.

KEY

To add the character in the name window.

SPACE

To add spaces in name window.

ARROW (lower right hand of screen)

To backspace one character.

CLEAR

To erase all characters in the name window.

ENTER

When satisfied with the sequence name. The Sequence Steps screen will appear and presets used in the sequence may be selected. See [5.18 Sequence Steps Screen](#).

5.18 Sequence Steps Screen

Figure 5.17 Sequence Steps screen

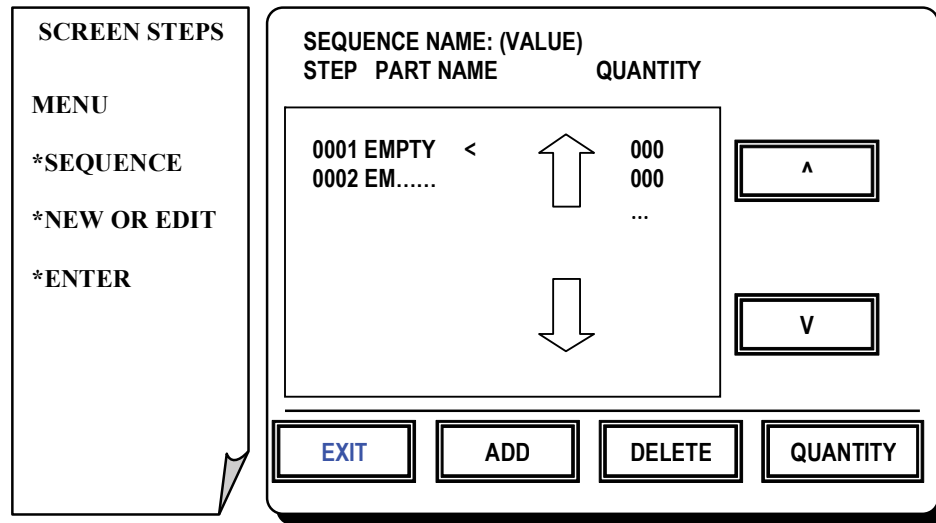

Sequence Steps Screen*

A sequence consists of a series of presets, each of which is executed a designated number of times. This screen allows selection of presets and assignment of quantities.

*Not available on Ultrasplice 40 & ST 40 actuators.

Press one of the following options for this screen:

UP or DOWN ARROWS

(Inside the storage register display window). To scan sequence steps a page at a time.

UP or DOWN ARROWS

(Outside the storage register display window). To position the selection cursor next to the storage register you wish to fill, edit or retrieve from.

ADD

To add a preset to the sequence. A screen will appear which allows you to select a preset from the preset library.

DELETE

To delete the selected preset from the sequence.

QUANTITY

To specify the number of times to execute the selected preset in the sequence (250 times maximum).

EXIT

When satisfied with the sequence steps. If the sequence is new or has been changed, an option to try the sequence (return to the Run Screen, see [5.2 Run Screen](#)) or exit (return to Sequence Menu, see [5.16 Sequence Menu Screen](#)) is given.

5.19 Sequence Library Screen

Figure 5.18 Sequence Library screen

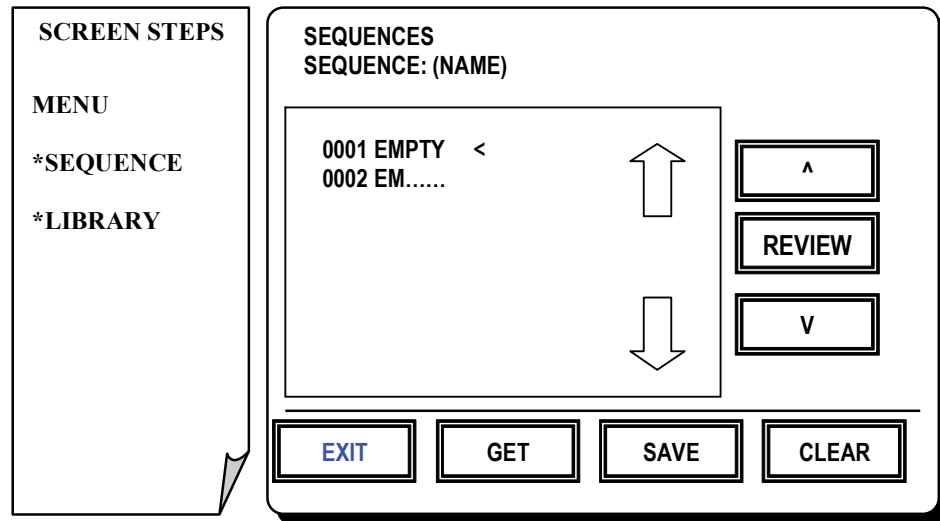

Sequence Library Screen

When a sequence has been named and configured it must be stored in the library memory in order to retrieve it at a later date. The sequence that has been created or is in use is shown at the top of the screen.

Not available on Ultrasplite 40 & ST 40 actuators.

Press one of the following options for this screen:

UP or DOWN ARROWS

(Inside the storage register display window). To scan the sequence library a page at a time.

UP or DOWN ARROWS

(Outside the storage register display window). To position the selection cursor next to the sequence storage register you wish to fill, edit or retrieve from.

REVIEW

To view the presets associated with the selected sequence.

GET

To retrieve the sequence into current memory.

SAVE

To retain the sequence information in a selected register.

CLEAR

To clear a stored sequence from its storage register.

EXIT

To return to the Sequence Menu. See [5.16 Sequence Menu Screen](#).

5.20 Height Adjustment Screen

Figure 5.19 Height Adjustment screen

SCREEN STEPS	HEIGHT ADJUSTMENT						
MENU	ADJUST HEIGHT TO THE ACTUAL MEASUREMENTS OF THE LAST WELD.						
*ADJUST	PART NAME: (VAL)						
	<table style="width: 100%; border-collapse: collapse;"> <thead> <tr> <th style="text-align: left;">RESULT</th> <th style="text-align: left;">MEASURED</th> <th style="text-align: right;">ADJUST</th> </tr> </thead> <tbody> <tr> <td>HEIGHT (VAL)</td> <td>(VAL)</td> <td style="text-align: right;"><input type="button" value="ADJUST"/></td> </tr> </tbody> </table>	RESULT	MEASURED	ADJUST	HEIGHT (VAL)	(VAL)	<input type="button" value="ADJUST"/>
RESULT	MEASURED	ADJUST					
HEIGHT (VAL)	(VAL)	<input type="button" value="ADJUST"/>					
	<input type="button" value="EXIT"/>						

Height Adjustment Screen*

The actual measured value of a weld may vary from the height setting in the controller. The height setting does not include added height of component material which extrudes into the knurl patterns of the tooling. This screen allows an offset compensation to be entered so that the resultant weld matches the set value for height. The result value is set in the controller and represents the desired actual dimension of the weld. The measured value is taken from an actual sample and input using the adjust button. The controller will then create a compensation factor to produce the desired weld size.

*Available only on Ultraweld 20, Ultraweld 40, MTS 20, & ST 40 actuators equipped with a height encoder which is set to on.

Press one of the following options for this screen:

ADJUST

To enter a measured height (mm) value. See [5.35 Typical Keypad Entry Screen](#).

EXIT

To return to Menu Options. See [5.3 Menu Options Screen](#).

5.21 System Configuration Screen

Figure 5.20 System Configuration screen

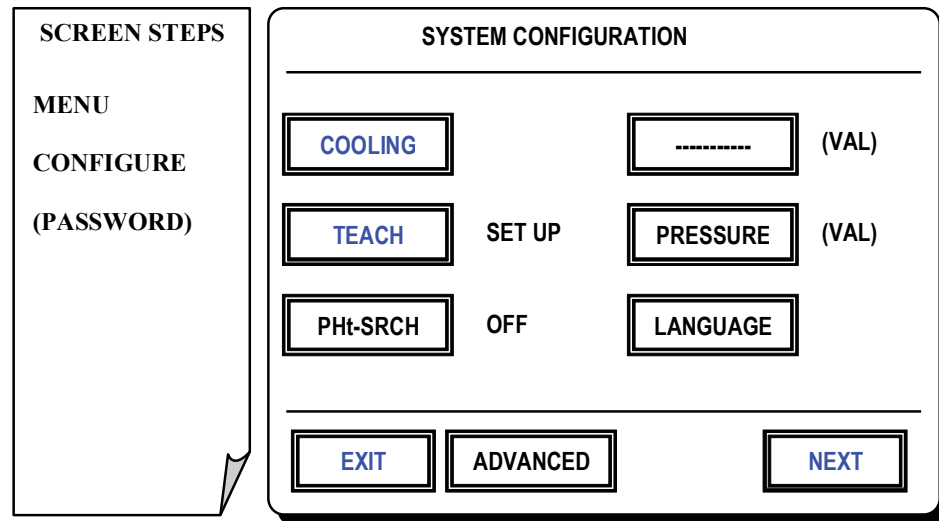

System Configuration Screen

Features in this screen are global and remain unchanged regardless of other weld setting or presets that are currently in use. The exception is Advanced settings which serve as defaults and may be overridden on an individual preset basis. See [5.6 Advanced Weld Settings Screen](#) for reference.

COOLING

To set timers that control post weld cooling air. See [5.22 Cooling Screen](#).

TEACH

To set mode and criteria for the teach function. The teach feature is a method for establishing weld limits. See [5.23 Teach Mode Setup Screen](#).

PHt-SRCH

To toggle Pre-Height Search function on and off.

ADVANCED (Default)

To set default values for advanced features. The screen and features are identical to those in Advanced Weld Settings. See [5.6 Advanced Weld Settings Screen](#) for reference.

PRESSURE

To toggle pressure units between PSI and bar.

LANGUAGE

To select a controller display language in English, Spanish, Portuguese, French or German.

NEXT

To view more configuration features. See [5.24 System Configuration Screen \(Next\)](#).

EXIT

To return to Menu Options. See [5.3 Menu Options Screen](#).

5.22 Cooling Screen

Figure 5.21 Cooling screen

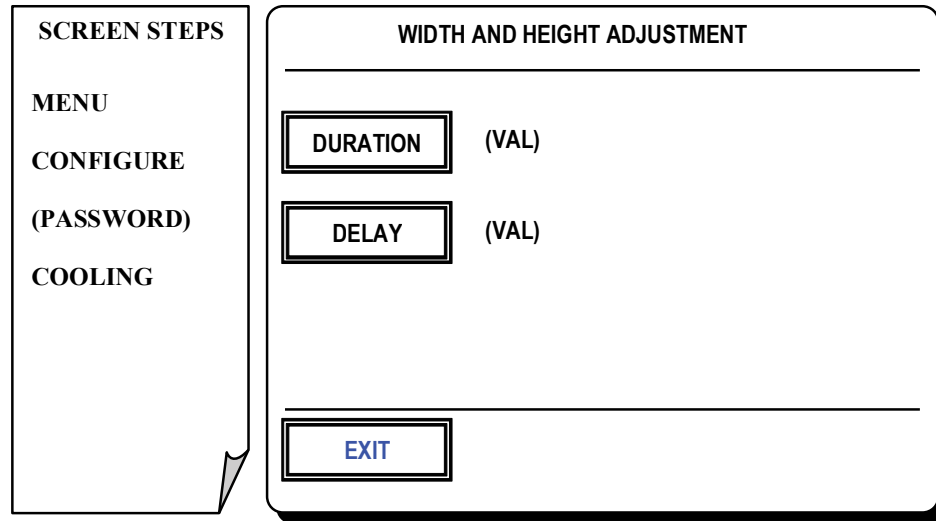

Cooling Screen

This screen allows access to timer settings which control post weld cooling air for tooling.

Press one of the following options for this screen:

DURATION

To change the length of time the cooling air is on after each weld cycle. See [5.35 Typical Keypad Entry Screen](#).

DELAY

To change the delay period after weld and before cooling air is turned on. See [5.35 Typical Keypad Entry Screen](#).

EXIT

To return to System Configuration. See [5.21 System Configuration Screen](#).

5.23 Teach Mode Setup Screen

Figure 5.22 Teach Mode Setup screen

SCREEN STEPS	TEACH MODE SETUP			
MENU	TIME	POWER	PREHEIGHT	HEIGHT
CONFIGURE	(VAL)% MAX	(VAL)% MAX	*(VAL)% MAX	*(VAL)% MAX
(PASSWORD)				
TEACH	(VAL)% MIN	(VAL)% MIN	*(VAL)% MIN	*(VAL)% MIN
	SAMPLES:		(QTY)	(MODE)
	EXIT	TEACH	^	v

Teach Mode Setup Screen

The teach feature may be used to establish weld limits (see [5.15 Weld Limits Screen](#) for reference) from a series of sample welds made by the user. Upon successful completion of the sample set the controller does the following:

- Calculates average values for Time, Power, Preheight and Height variables
- Factors the allowable min/max deviation percentages as entered in this screen
- Uses the resultant values to create the weld limits

There are two teach modes available as means to do sampling. The mode in use will be displayed at the top of this screen. These modes are as follows:

In the Standard Teach Mode the user may accept or reject each weld as part of the sample set. The button to accept the samples will appear to the right of the TEACH button on the Run Screen. Sample sets of 1 to 50 may be used.

In the Auto Teach Mode the user may not reject samples. Instead, the first five welds form a basis using the averaged values for Time, Power, Preheight and Height. A plus or minus ten percent tolerance is added to these averages which are used to evaluate the acceptability of the remaining samples. If a remaining sample falls outside of this range it is rejected and an alarm occurs. A teach session may encounter up to three errors in the first 15 welds made after which the sampling must be started over. Once completed the preset must be saved. When the preset is recalled again the controller will use the saved quality windows for the first five welds, after the first five welds are made, the controller will recalculate the windows to plus or minus ten percent and follow the same routine as stated above for the auto teach mode. Auto Teach mode will automatically reactivate when you change any of the weld parameters, quality windows or recall a new preset.

Once the teach mode sample size and variation criteria has been established, a sample run may be initiated by pressing the TEACH button on this screen or on the Run Screen.

Press one of the following options for this screen:

ANY MIN/MAX % VALUE*

To select an allowable deviation to be applied to the sample average. Availability of Preheight and Height settings is actuator dependent.

*Available only on Ultraweld 20, Ultraweld 40, MTS 20, & ST 40 actuators equipped with a height encoder which is set to on.

(MODE)

To toggle between Standard and Auto teach modes.

(QTY)

To enter a quantity for the sample set. The sample set may include up to fifty welds. In Auto mode the sample set has a fifteen weld minimum.

TEACH

To put the controller in teach mode.

EXIT

To return to System Configuration. See [5.21 System Configuration Screen](#).

5.24 System Configuration Screen (Next)

Figure 5.23 System Configuration screen (Next)

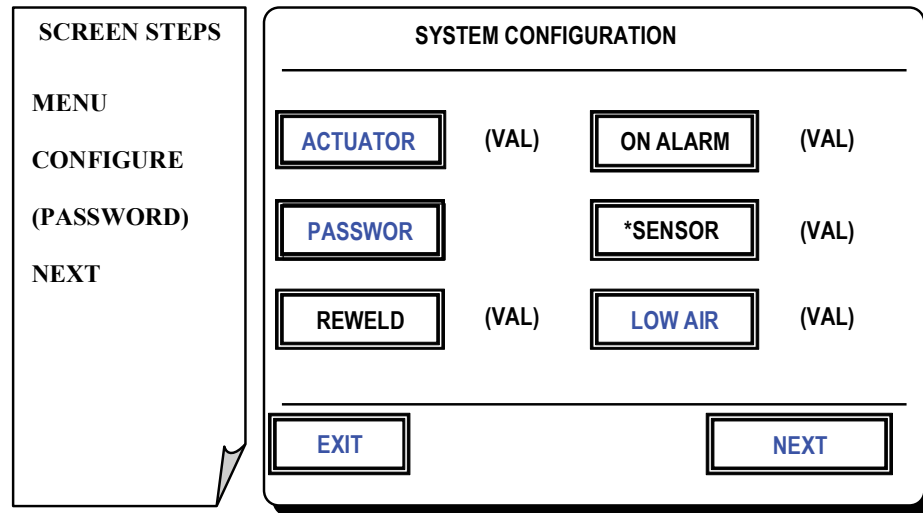

System Configuration Screen (Next)

This screen allows access to other configuration settings.

Press one of the following options for this screen:

ACTUATOR

To configure the controller for the correct actuator. See [5.25 Actuator Selection Screen](#).

PASSWORD

To create passwords that control operator access to the touchscreen commands. See [5.26 Password Changing Screen](#).

REWELD

To toggle the reweld mode on/off. This provides an option when a weld limit alarm (see [5.15 Weld Limits Screen](#) for reference) occurs. If the reweld setting is on the user may choose to reweld the same part again. Weld limits are turned off for one cycle while the reweld takes place.

ON ALARM

To toggle between lock or allow a weld to continue when an alarm condition exists. When set to lock the actuator will not release the part until a level 1 password is entered.

***SENSOR**

To toggle between Full/Half height encoder.

*Make sure the L20 Actuator is selected to enable this function.

LOW AIR

To set options and threshold for low line air pressure. See [5.28 System Configuration Screen \(Next, Next\)](#).

NEXT

To view more configuration features. See [5.28 System Configuration Screen \(Next, Next\)](#).

EXIT

To return to System Configuration. See [5.21 System Configuration Screen](#).

5.25 Actuator Selection Screen

Figure 5.24 Actuator Selection screen

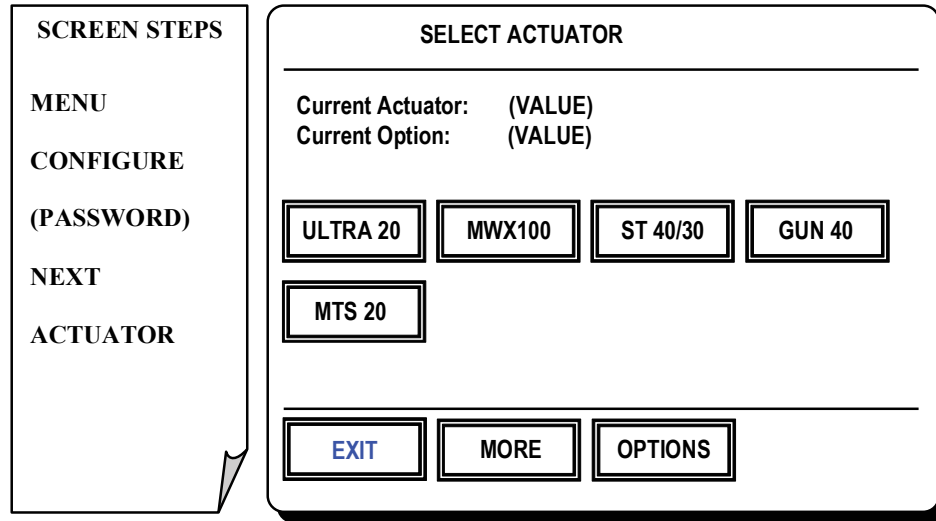

Actuator Selection Screen

This screen is used to match the controller firmware to its attached actuator type.

Press one of the following options for this screen:

ULTRA 20

To configure the controller for the Ultraweld L20 actuator.

MWX100

To configure the controller for the MWX100 actuator.

ST 40/30

To configure the controller for the ST 30/40 actuator (plastic tube sealing).

GUN 40

To configure the controller for Gun 40 actuator.

MTS 20

To configure the controller for the Ultraseal 20 actuator (metal tube sealing).

OPTIONS (Ultraweld L20, MWX100, and Ultraseal 20 Only)

To select available options:

- Normal Mode/Double Hit Mode: To switch between normal mode and Double Hit mode (used for automation). Do not activate Double Hit Mode unless instructed by Branson (Ultraweld L20 and MWX100 only)
- Use FootSwitch/Use StartHandle: Used to select between using a foot switch or a start handle to begin the weld cycle (Ultraseal 20 Only)

EXIT

To return to System Configuration. See [5.24 System Configuration Screen \(Next\)](#).

5.26 Password Changing Screen

Figure 5.25 Password Changing screen

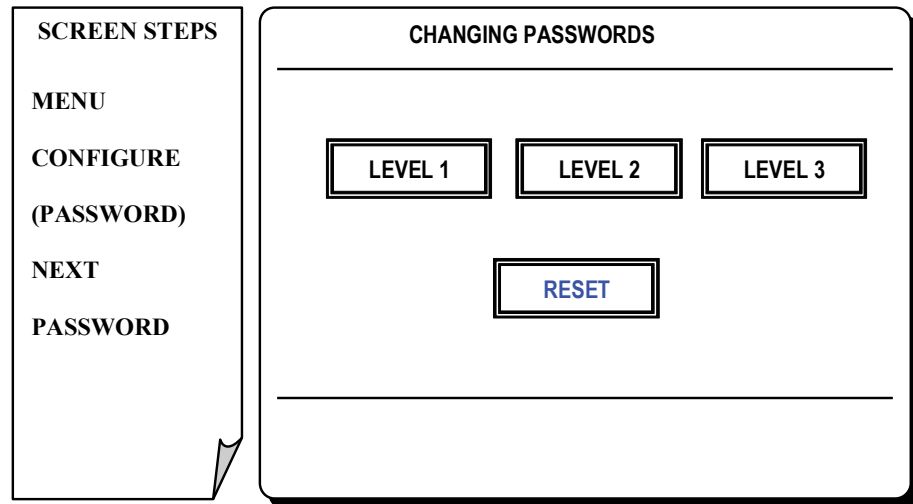

Password Changing Screen

This screen is used to create passwords that control operator access to the touchscreen commands.

Level 1 passwords restrict access to the following screens:

Settings	Quality
Sequence	Splices
Teach	Adjust

Level 2 passwords restrict access to the Configuration, Maintain and Diagnostic screens. In order to use a Level 1 password a Level 2 password must be set.

Level 3 passwords restrict access to the following screens:

Quality limits key pads	Make a new splice	Teach Button
Weld setting key pads		

A Level 1, Level 2, or Level 3 password which is set to "0" turns password protection off. The factory settings for the controller are "0" for Level 1, 3 and "2677" for Level 2.

To change a password the user must first enter the current password. If password protection is off, enter "0" as the current password. A new password may then be entered.

A password may be up to 4 numbers Max.

Press one of the following options for this screen:

LEVEL 1

To change the Level 1 password setting.

LEVEL 2

To change the Level 2 password setting.

LEVEL 3

To change the Level 3 password setting.

RESET

To return to System Configuration. [5.24 System Configuration Screen \(Next\)](#).

5.27 Low Air Alarm Screen

Figure 5.26 Low Air Alarm screen

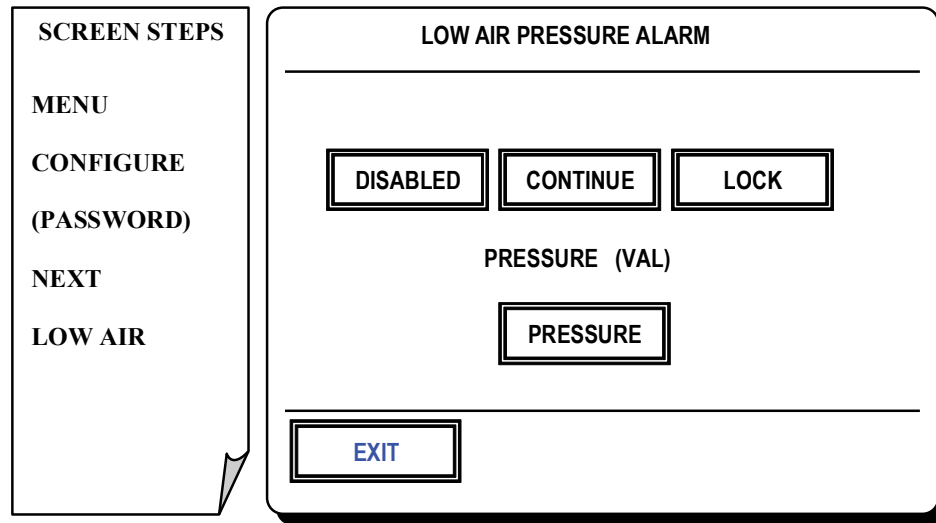

Low Air Alarm Screen

This screen is for setting low air line pressure alarm options.

Press one of the following options for this screen:

DISABLED

To disable low pressure alarm. Select this setting if the system is not equipped with a pressure switch.

CONTINUE

To finish weld after sensing low pressure.

LOCK

To not allow weld after sensing low air pressure.

PRESSURE

To set the alarm threshold for low line pressure. See [5.35 Typical Keypad Entry Screen](#).

EXIT

To return to System Configuration. See [5.24 System Configuration Screen \(Next\)](#).

5.28 System Configuration Screen (Next, Next)

Figure 5.27 System Configuration screen (Next, Next)

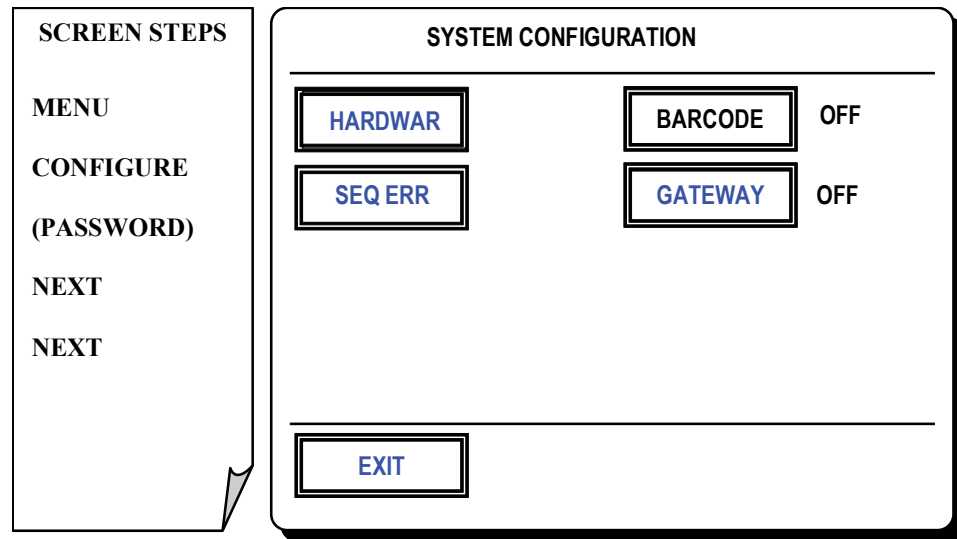

System Configuration Screen (Next, Next)

This screen allows access to other configuration settings.

Press one of the following options for this screen:

HARDWARE

To set information feedback devices. See [5.29 Transducer Configuration Screen](#).

SEQUENCE ERROR

To set error handling options when running in Sequence mode. See [5.30 Sequence Error Screen](#).

BARCODE

To enable/disable barcode functionality.

GATEWAY*

To enable/disable Gateway functionality.

EXIT

To return to System Configuration. See [5.24 System Configuration Screen \(Next\)](#).

*Available only on Ultraweld 20. Refer to Data Interface Gateway Manual 1026686 for setting up the Module RS232 to Ethernet.

5.29 Transducer Configuration Screen

Figure 5.28 Transducer Configuration screen

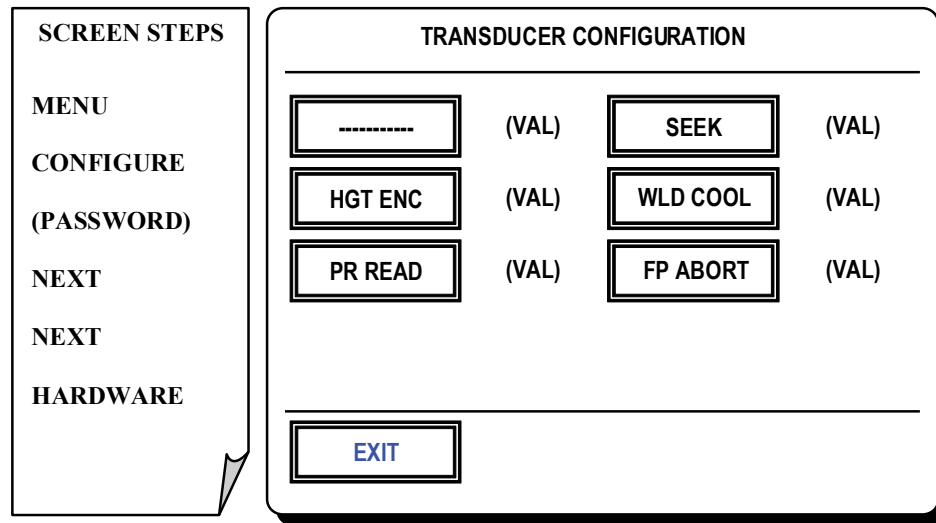

Transducer Configuration Screen

This screen allows control of information feedback devices on the actuator.

Press one of the following options for this screen:

HEIGHT ENCODER*

To toggle height encoder on/off

*Not available on Ultrasplice 40 & ST 40 actuators.

PRESSURE READING

To toggle pressure reading transducer on/off

SEEK

To toggle on/off seek function. This pulses ultrasonic energy to the stack prior to each weld in order to allow the system to tune to stack frequency.

WLD COOL

Enables the setting of a predetermined amount of time the cooling air will stay on after a weld.

FP ABORT

When enabled, foot pedal must be maintained until sonic starts or the weld cycle will be aborted.

EXIT

To return to System Configuration. See [5.28 System Configuration Screen \(Next, Next\)](#).

5.30 Sequence Error Screen

Figure 5.29 Sequence Error screen

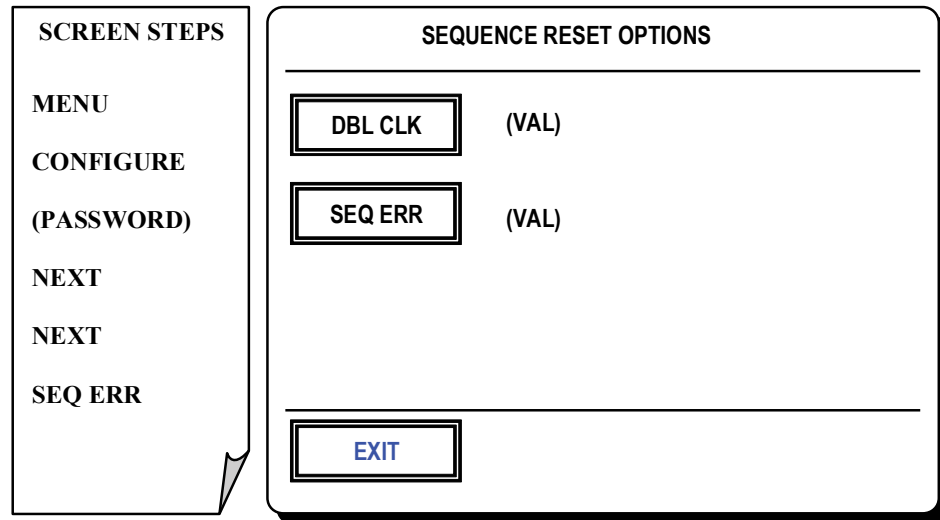

Sequence Error Screen

When a weld error occurs while running in Sequence mode, options are available for when the system is reset. This screen allows for setting these options.

The double click functions are applicable only when the controller is equipped with a remote reset button.

Press one of the following options for this screen (Display will toggle between options):

DOUBLE CLICK (To Next)

To move to the next step in the sequence.

DOUBLE CLICK (Not Allowed)

Turns Double Click option off.

DOUBLE CLICK (Restart)

Restart – to restart sequence from step 1.

SEQUENCE ERROR

To toggle between sequence options which apply after a weld error is cleared.

Restart: To restart the sequence from step 1.

Reweld: To reweld the same step in the sequence.

EXIT

To return to System Configuration. See [5.28 System Configuration Screen \(Next, Next\)](#).

5.31 Gateway Feature

Figure 5.30 Enabling the Gateway feature

The screenshot shows a terminal window with two main sections. On the left, a vertical list of menu steps is shown: SCREEN STEPS, MENU, CONFIGURE (PASSWORD), NEXT, NEXT, and GATEWAY. On the right, the GATEWAY RECORD OPTIONS screen is displayed, featuring three toggle options: DATA OFF, PRESETS OFF, and SYS CONF OFF. An EXIT button is located at the bottom of the options screen.

SCREEN STEPS	GATEWAY RECORD OPTIONS
MENU	<input type="checkbox"/> DATA OFF
CONFIGURE (PASSWORD)	<input type="checkbox"/> PRESETS OFF
NEXT	<input type="checkbox"/> SYS CONF OFF
NEXT	
GATEWAY	<input type="button" value="EXIT"/>

Enable the data type that you want to send to the Gateway:

DATA

Enable Weld Data to be sent to the Gateway.

PRESETS

Enable Preset information to be sent to the Gateway.

SYS CONF

Enable System Configuration information to be sent to the Gateway.

5.32 Diagnostic Screen

Figure 5.31 Diagnostic screen

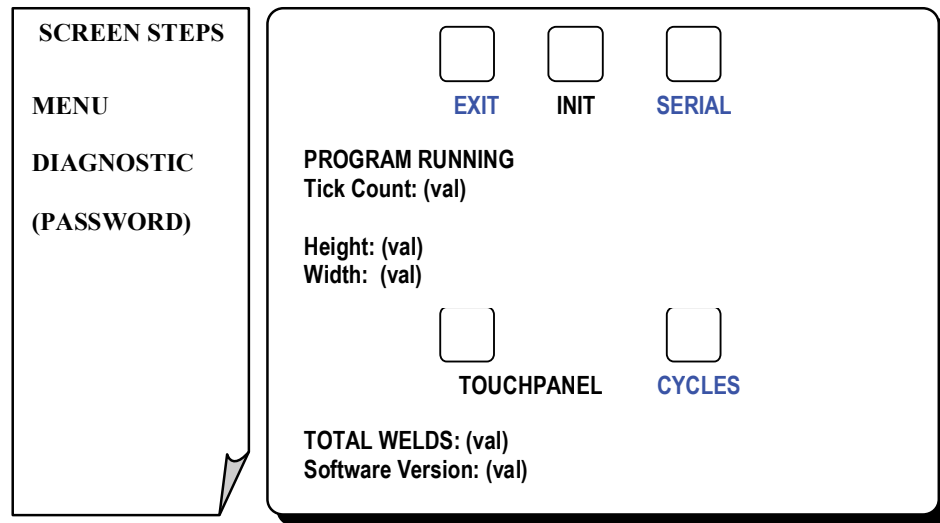

Diagnostic Screen

This screen allows access to operating system settings and information.

Press one of the following options for this screen:

INITIALIZE

To reinitialize the controller for software upgrades or in the unlikely event of a system failure. An option of partial or full initialization will be presented. A partial initialization will save all presets and sequences stored in the controller library.

NOTICE	
	<p>A full initialization will not save all presets and sequences stored in the controller library.</p>

SERIAL

To set baud rate and test serial communications. See [5.33 Serial Port Diagnostic Screen](#).

TOUCH PANEL

To go through a series of steps which recalibrate the touch panel. This is a factory set calibration that should not need adjustment.

CYCLES

To set options for automatic actuator cycling used for testing. See [5.34 Cycles Screen](#).

EXIT

To return to Run Mode. See [5.2 Run Screen](#).

5.33 Serial Port Diagnostic Screen

Figure 5.32 Serial Port Diagnostic screen

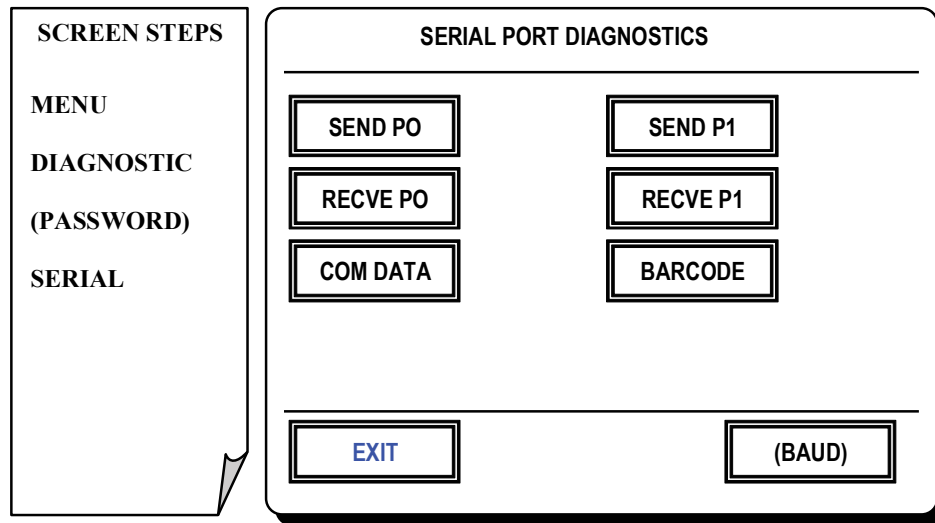

Serial Port Diagnostics Screen

This screen is to setup test and move data between two controllers or a controller and a PC. The button functions are described below. For precise instructions on how to save/transfer preset and sequence information see [5.37 Saving/Transferring Preset and Sequence Information](#).

Press one of the following options for this screen:

SEND PO

To send 10,000 "U" characters to Port 0 as test transmission

RECEIVE PO

Allows message typed on PC (hyperterminal) to be displayed on touchscreen.

COM DATA

Allows sending of stored Preset or Sequence information to Port 0.

SEND P1

To send 10,000 "U" characters to Port 1 as test transmission.

RECEIVE P1

Allows message typed on PC (hyperterminal) to be displayed on touchscreen.

BARCODE

To initialize Port 1 to receive barcode data.

BAUD

To set baud rate value for Port 0. (Port 1 baud is fixed at 9600).

EXIT

To return to Diagnostics. See [5.32 Diagnostic Screen](#).

5.34 Cycles Screen

Figure 5.33 Cycles screen

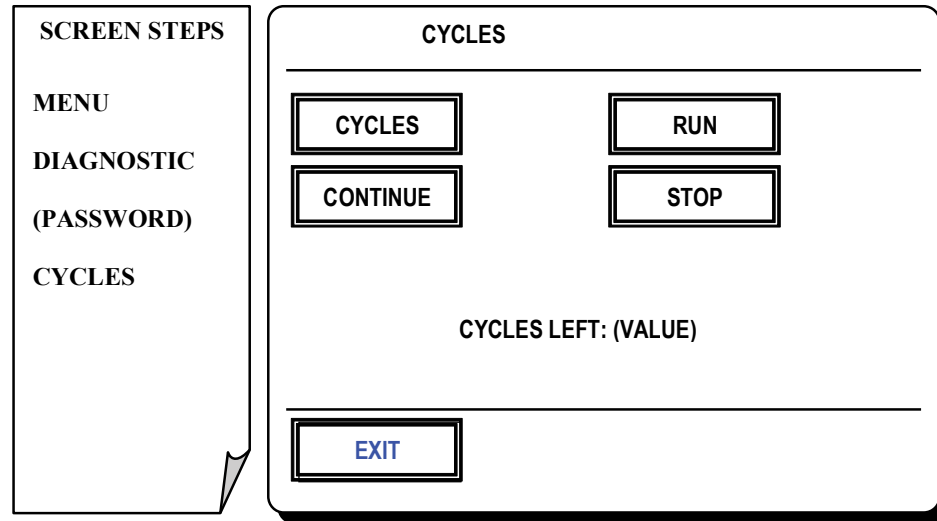

Cycles Screen

This screen allows automatic cycling of the weld actuator for a designated number of cycles. This feature is used for test purposes.

Press one of the following options for this screen:

CYCLES

To set the number of cycles to be completed. See [5.35 Typical Keypad Entry Screen](#).

CONTINUE

To continue the actuator cycling after initiating a stop command without resetting the counter.

RUN

To start actuator cycling.

STOP

To stop actuator cycling

EXIT

To return to Diagnostics. See [5.32 Diagnostic Screen](#).

5.35 Typical Keypad Entry Screen

Figure 5.34 Typical Keypad Entry screen

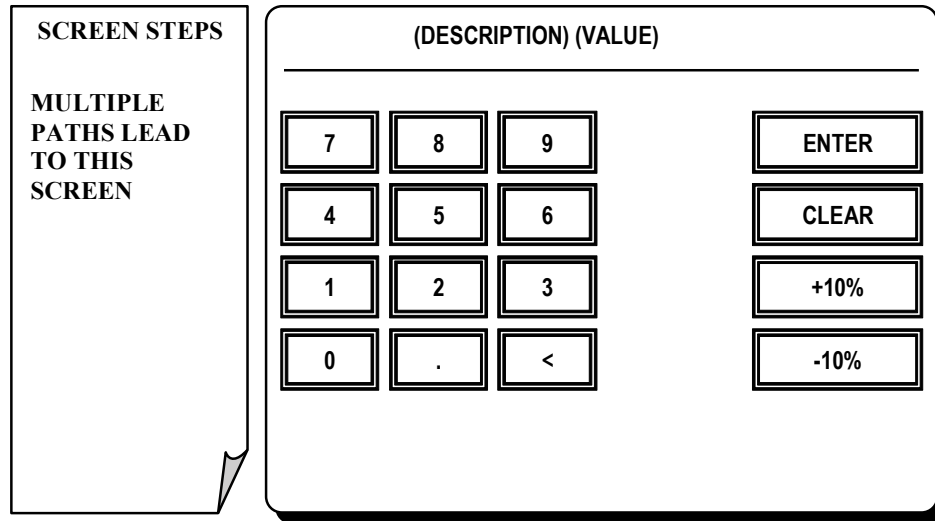

Typical Keypad Entry Screen

A number of touchscreen menu paths lead to a numerical entry keypad screen similar to that shown above. Generally the current variable and its value are displayed at the top of the screen.

Note that some screens do not contain the 10% keys.

Press one of the following options for this screen:

NUMERIC KEYPAD

To enter a new value.

+10% or -10%.

To increment the current setting by plus or minus 10 percent.

CLEAR

To undo the value you entered.

CLEAR then ENTER

To return to settings and leave the previous value unchanged.

ENTER

To save the new value and return to previous screen.

5.36 Advanced Function Switch Select

Once you connect external controls to the power supply, you can set the following Advanced

Functions using the Switch Select block:

- **Seek:** Provides options for controlling, monitoring, and storing operating frequency
- **Amplitude Control:** Allows for varying amplitude (50% - 100%) via external controls or keeping the amplitude fixed
- **Select Start:** Provides four starting ranges. Select start allows the power supply to ramp amplitude to accommodate different converter and load requirements
- **Memory:** Stores horn frequency at end of each weld

See [Figure 5.35 Advanced Functions Dip Switch](#) for switch location. Refer to [Table 5.1 Advanced Function Switch Select Table](#) for switch settings.

Table 5.1 Advanced Function Switch Select Table

Function	Options	Set Toggles...
Seek	Seek on power up - Checks horn frequency upon power up and stores it in memory.	1 - Closed = OFF 1 - Open = ON (Default)
	Auto Seek - Checks horn frequency once each minute, timed from the last activation of ultrasonics.	2 - Closed = OFF 2 - Open = ON
	Auto Seek Duration - Indicates the length of time the Auto Seek function is active.	3 - Closed = 100 ms 3 - Open = 500 ms
	Store at End of Weld - Updates horn frequency memory at the end of each weld.	4 - Closed = OFF 4 - Open = ON
Amplitude Control	Variable - Front panel adjustment of amplitude (50% to 100%) NOTICE Pin 6 must be Open or Amplitude Control will not work.	6 - Closed = Fixed at 100% 6 - Open = Variable (Default)
Start	Short - Sets ramp time to 10 ms.	7 - Closed 8 - Closed
	Medium - Sets ramp time to 35 ms.	7 - Open 8 - Closed
	Standard - Sets ramp time to 80 ms.	7 - Closed 8 - Open (Default)
	Long - Sets ramp time to 105 ms.	7 - Open 8 - Open

Figure 5.35 Advanced Functions Dip Switch

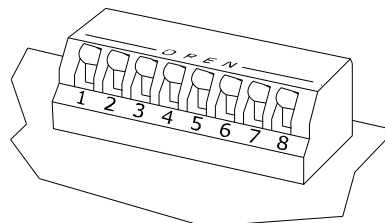

5.37 Saving/Transferring Preset and Sequence Information

Equipment required:

- Standard IBM PC Null Modem cable
- A computer running Windows®* HyperTerminal and a standard RS232 serial port. Other computers may be configured to work but will require additional instructions
- A Branson Touchscreen Controller version 5.03.00 or later. It must be configured and ready to run

*Windows is a registered trademark of Microsoft Corporation.

Download Procedure:

- Connect the PC to the touchscreen controller (connection P105) with the Null Modem cable. Note the PC COM port because it will be required for setting HyperTerminal. Do not start the controller at this time
- From the PC, start HyperTerminal (Usually in the Accessories program menu folder)
- Setup a HyperTerminal connection (File, New Connection). Use the default settings with the following changes:

Table 5.2 HyperTerminal Connection

Set Phone Number	Direct to Com 1 (or Com 2 as available)
------------------	---

In Configure set:

Table 5.3 RS232 Serial Port Configuration

Bits per second	19200 (Default for TouchScreen)
Data bits	8
Parity	None
Stop bits	1
Flow control	None
In Settings Set Emulation	VT52

- Save and connect with the new connection
- Turn on touchscreen controller. HyperTerminal view window should show:

UUIA1

:020000030900F2

:02000000C740f7

:0100000100FE

This is the touchscreen's sign on to an attached serial port. It is always sent when the control starts to tell any waiting device that the COM port is active. If you do not see this sign on or the characters are unusual check the settings. The baud rate may have been changed or if there is no display check the Null Modem cable and COM port assignment.

- From the touchscreen controller go to the Serial Port Diagnostics Screen. (Menu> Diagnostic > Password> Serial)
- Check the BAUD rate at the lower right corner of the screen. It must match the Bits per second used in HyperTerminal

- From the PC HyperTerminal go to Transfer, Capture Text
- It is recommended that the data be stored on a floppy disk in the A: drive. A file name a:\tsdata.txt or similar can be used. Use a .txt extension
- From the touchscreen controller press COM DATA. When the next screen appears press PRESETS or SEQUENCE to upload the data to the PC HyperTerminal
- When all data has been sent to the PC go back to Transfer, Capture Text and Stop. This will close the file with data stored

Upload Procedure:

The captured text file contains all the information required to return the data back to any waiting touchscreen controller. Assuming the HyperTerminal setup was saved, load that setup to start the system. If you have not saved the setup you can use the above steps to setup a new HyperTerminal session.

NOTICE	
	<p>Leave the controller at the RUN screen. From the PC, use the Send Text File (instead of Capture Text) to upload the file to the controller.</p>

Controller to Controller

The PC is required only to store the data. If desired, two touchscreen controllers can be attached via the Null Modem cable and the data sent directly from one controller to another. The BAUD rate must be identical, there is no other setup.

5.38 Safety Circuit Alarms

The Safety Control System within the Controller constantly monitors the system's safety related components for correct operation. When this system detects a fault condition, operation is interrupted and the system immediately goes to a safe state. A beeper is used to signal a safety system alarm.

Use the following procedure to troubleshoot safety circuit alarms:

1. Verify that the 9-pin footswitch cable is properly connected to the back of the Controller.
2. Power down and then power up the Controller to reset the system.
3. If the alarm persists, call Branson Support.

Chapter 6: Maintenance

6.1	Preventive Maintenance	84
6.2	Parts Replacement	85
6.3	Parts List	86

6.1 Preventive Maintenance

The following preventive measures help assure long term operation of your Branson equipment.

WARNING	General Warning
	<ul style="list-style-type: none"> • All system components must be disconnected from the main electrical supply • Remove the plug from the main electrical supply and secure it from being re-inserted accidentally • Use LOTO (Lock Out Tag Out) lockable plug cover over line cord plug during any maintenance • Disconnect the air hose from the main air supply • Before you begin to disassemble any parts of the controller, ensure that it is turned off, and the main power is disconnected. Wait at least 5 minutes to allow capacitors to discharge • High voltage is present in the power supply. Do not operate with the cover removed. High line voltages exist in the ultrasonic power supply module. Common points are tied to circuit reference, not chassis ground. Therefore, use only non-grounded, battery-powered multimeters when testing these modules. Using other types of test equipment can present a shock hazard

6.1.1 Periodically Clean the Equipment

Air is continuously drawn into the Branson Touchscreen Controller. Periodically disconnect the unit from power, remove the cover and vacuum out any accumulated dust and debris. Remove material adhering to the fan blades and motor, transistors, heat sinks, transformers, circuit boards, cooling intake vents, and exhaust ports. Filters can be added to the Touchscreen Controller cooling fans for dusty environments. External covers may be cleaned with a damp sponge or cloth using a solution of mild soap and water. Do not allow cleaning solution to enter the unit. To prevent rust in areas of high humidity, exposed steel surfaces, such as handles, hardware, and the main column may require a very light film of oil, such as WD-40®*.



*WD-40 is a registered trademark of WD-40 Manufacturing Company Corporation.

NOTICE	
	<p>When it is necessary to clean the touch screen, wipe gently with a soft cloth dampened with a mild detergent or a window glass commercial cleaner. Give a final wipe to the entire screen with the soft damp cloth. Under no circumstances should you use solvents or ammonia to clean the screen.</p>

6.1.2 Routine Component Replacement

The lifetime of certain parts is based on the number of cycles the unit has completed, or on hours of operation, e.g., at 20,000 hours, cooling fans should be replaced.

6.2 Parts Replacement

WARNING	General Warning
	<p>If a particular module has failed, it should be replaced or repaired at an Branson Depot Facility.</p>
CAUTION	High Voltage Hazard
	<p>The Branson Touchscreen Controller contains components that can be degraded or damaged by electrostatic discharge. Always use a Grounded Wriststrap and use a grounded work area when handling or servicing the Touchscreen Controller.</p>

The Touchscreen Controller is designed for a long service life. In the event the system malfunctions, many of the internal components (Modules) are replaceable as a unit.

Power Supply Cover

The cover is held in place with seven screws, three on each side of the case and one on the rear. Lift the rear of the cover up to remove it. The cover must be in place when the system is operating due to fan-forced ventilation design.

Circuit Boards and Modules

Replaceable modules are shown in [Figure 6.1 Touchscreen Controller - Top view with cover removed](#). Be sure to note ribbon cable and connector orientation prior to removing components for maintenance or replacement. The cooling fans use identical wiring harnesses, with one tying back the 'extra' lead length. Make note of any wiring paths if you are removing a module, before you disassemble. In some cases, there are several possible paths, but one preferred location. Be especially careful with harnesses and wires that go between the two portions of the case, as they can be pinched by the metal case if miss-routed.

6.3 Parts List

This section provides the list of replacement parts.

Table 6.1 Suggested spares

Item	Description	Part Number
1	Power Supply Module	100-244-043R (3300w) 159-244-069R (4000w)
2	Line Filter Module	100-242-1199R (100-242-1230R for 4KW units only)
3	DC Power Module	200-132-294R
4	Cooling Fans	100-126-015R
5	Touch Screen	1020969
6	LCD Display	200-220-040
7	Front Panel Board	100-242-1077R
8	Power Switch	1032510
9	Machine Controller Board	102-242-968
10	CPU Board	102-242-1272R
11	Motor Control Board (Splicer)	Call Branson
12	Ground Stud	200-098-870 203-144-089 200-073-231 200-114-170
13	Pneumatic Kit	See Special Info Instruction Set

Figure 6.1 Touchscreen Controller - Top view with cover removed

