



**EMERSON**<sup>™</sup>

Original Instructions  
DCM01246 - REV. 06

# MWX100, VGX Metal Welding System

# Product Manual

**Branson Ultrasonics Corp.**  
120 Park Ridge Road  
Brookfield, CT 06804  
(203) 796-0400  
<http://www.bransonultrasonics.com>

**BRANSON**

## Introduction

This is the product manual for your BRANSON Metal Welding ultrasonic welding system.

Several combined Instruction Sets form the contents of this manual. This section contains information which relates most uniquely to you as the customer, your particular system and application. It also documents other Instruction Sets used in the manual. The figure below illustrates how the manual is organized.

Branson Metal Welding Product Manual

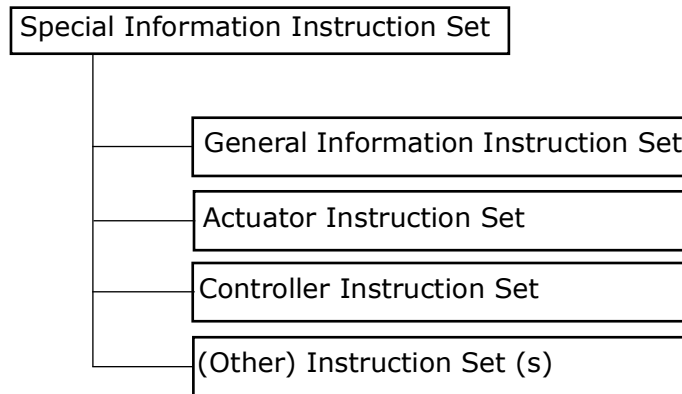



## Using this manual

It is highly recommended that you read and understand the contents of this manual prior to operating your Branson Metal Welding system. Each Instruction Set has a table of contents and is intended to logically group information in a manner which the user will find convenient.

## Classification of Hazards

The safety indications in this manual are divided into different classes. The figure below shows the assignment of symbols (pictograms) and signal words to the specific hazards and its potential consequence.

<b>DANGER</b>	
	A potentially dangerous situation that could cause injury to persons and serious damage to equipment.

<b>CAUTION</b>	
	A situation that may cause damage to the equipment.

<b>NOTICE</b>	
	Useful information, an application hint or other important or useful information.

## File Attachments

**Table 1.1** File Attachments

Description	File
Assembly Drawing	159-134-341

REVISIONS

ZONE	REV	DESCRIPTION	DATE	ECN/ECO	DRAWN	APPR.
---	1	UPDATED ITEM 28, DELETE BALLOONS 98 & 97. ADDED BALLOON 102. ADDED NOTE 3 ON PAGE 2	9/29/09	0-2153	---	DAS
---	2	UPDATED BALLOONS 44, 78, 79, 80, 82. DELETED BALLOON 81 ADDED BALLOONS 103, 104, & 105.	10/28/09	0-2159	---	DAS
---	3	UPDATED BACK LABELS POSITION.	1/7/10	0-2163	ERS	MGD
---	4	REDRAWN IN SOLID EDGE.	7/30/10	18547	WIPRO	D.SULIK
9B	05	UPDATED BEZEL BALLOON 84 AND LABEL BALLOON 89 SHEET 4	11/16/11	19105	JVL	ERS
---	06	ADDED WARNING LABEL 100-065-613 BALLOON 106 (page 4)	12/21/11	19151	JVL	MD
---	07	REMOVED ITEM #54	02/24/12	19207	CRS	JJF
B7(SH3)	08	ADDED DETAIL A FOR LABEL 100-065-1162	09/03/12	19565	CRS	ERS
C6(SHT3)	09	LABEL "CE" REMOVED	6/20/13	20104	JVL	ERS
B3 (SH1), A10 (SH4)	10	ADDED CALLOUT ON BALLOON 87, AND ADDED NOTE 1	05/05/15	21151	DHM	AAAH
---	11	ADD 'SEE NOTE 5' TO BALLOON 102; MOVE SH1 NOTE 1 TO SH2 AS NOTE 4, CHANGE SH4 'SEE NOTE 1' TO 'SEE NOTE 4' IN BALLOON 87; ADD NOTE 5 IN SH2; ADD 'USE LOCTITE 545' TO BALLOON 35,36;	6/09/15	21263	FZHAO	ERS
G7 (SH2)	12	ADDED NOTE 6	04/13/16	21675	VADV	VADV
D3, D6, G7 (SH2), B6 (SH4)	13	REPLACED BALLOON 31, 32 & 33 WITH 203-897 BALLOON 107; REPLACED 200-298-295 WITH 203-693 SAME BALLOON 34; REPLACED 200-098-954 WITH 200-098-844 SAME BALLOON 75.	07/05/17	22166	VADV	MGD
A10 (SH4)	14	REPLACED SEE NOTE 4 TO SEE NOTE 3.	8/10/17	22191	VADV	VADV
---	15	UPDATED PER IMPACT ANALYSIS.	9/19/17	22210	AAMG	VADV
---	16	UPDATED PER IMPACT ANALYSIS.	9/25/17	22221	AAMG	VADV
G7, G8-G9 (SH3)	17	ADDED BALLOON 96 (HOSE 200-110-078 QTY. CHANGED FROM 0.10417 FT. TO 1.1875 FT.)	03/01/18	101019	VADV	VADV
---	18	UPDATED PER IMPACT ANALYSIS.	2/6/20	102291	OZG	HTR
---	19	ADDED P/N 200-298-005 QTY 2 BALLOON 108 AND 1017376 QTY 1 BALLOON 109.	4/14/20	102516	OZG	VADV
B3, D6	20	CHANGED P/N 200-298-287 WITH 100-298-315 SAME QTY & BALLOON.	4/20/21	103115	OZG	VADV
C9, C7 (SH3); G4, D2 (SH4)	21	REPLACED ITEM 200-298-285 FOR 100-298-347 (ITEM 44)	4/3/24	105195	JCN	JVL
F6, G6 (SHT4)	22	ADDED ITEM 110	6/25/24	105260	JCN	JFV

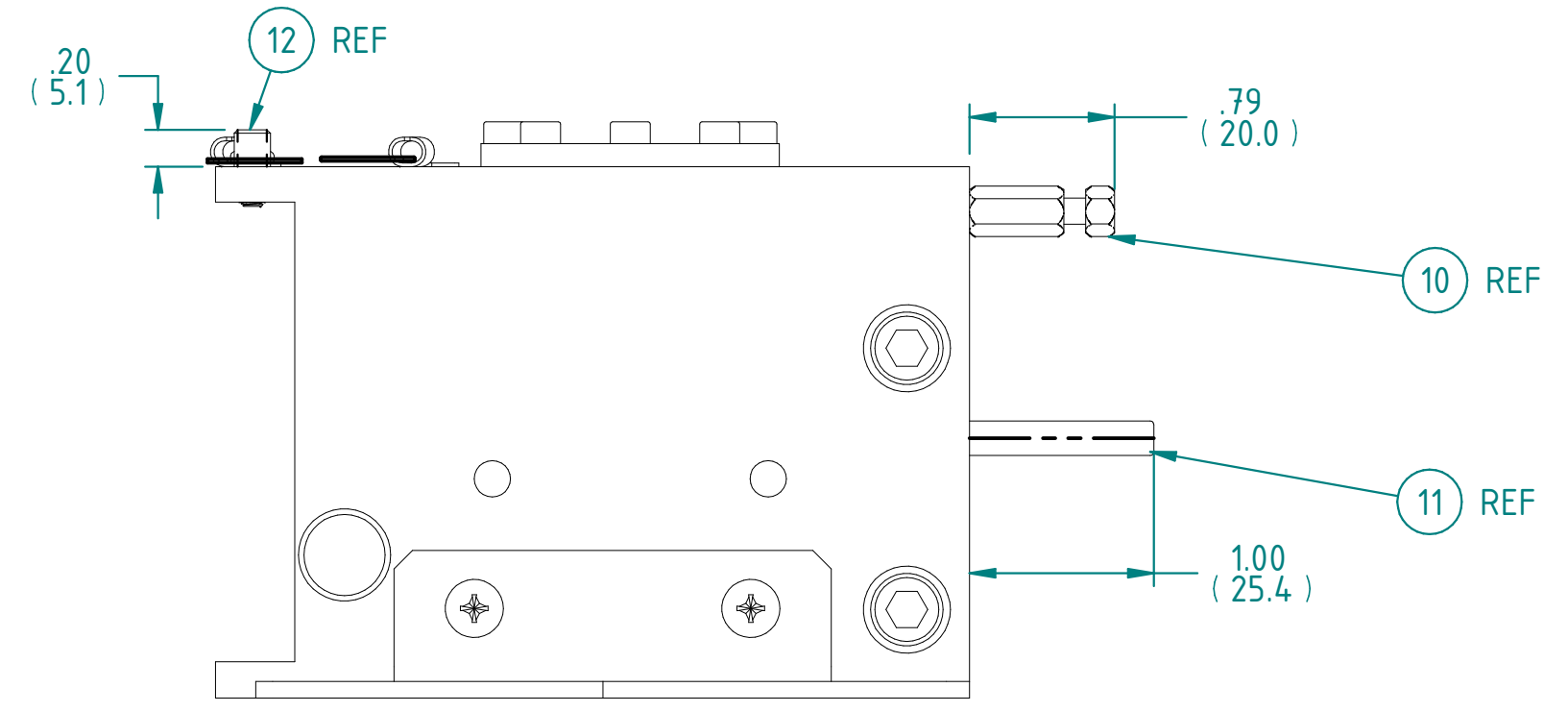
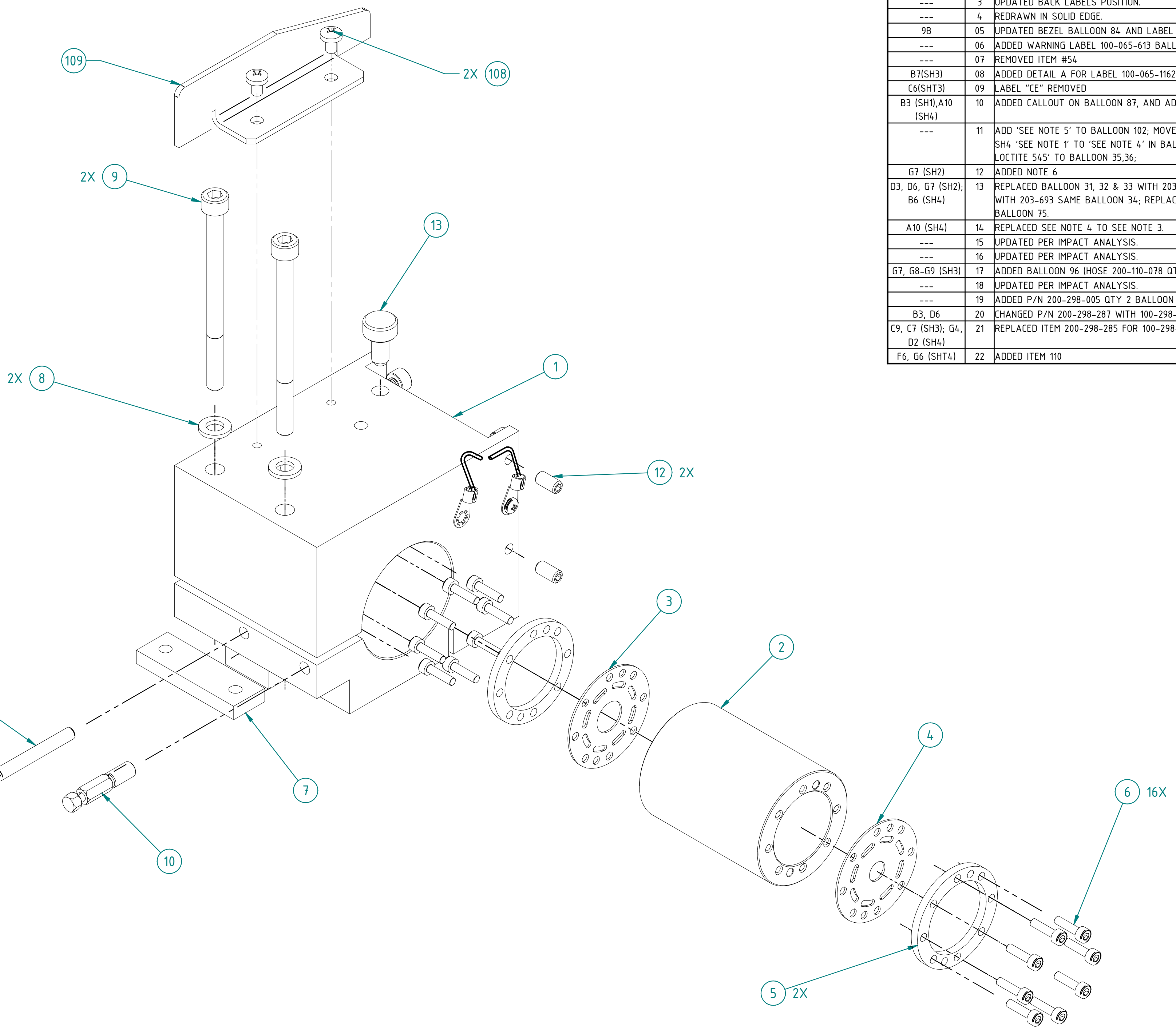
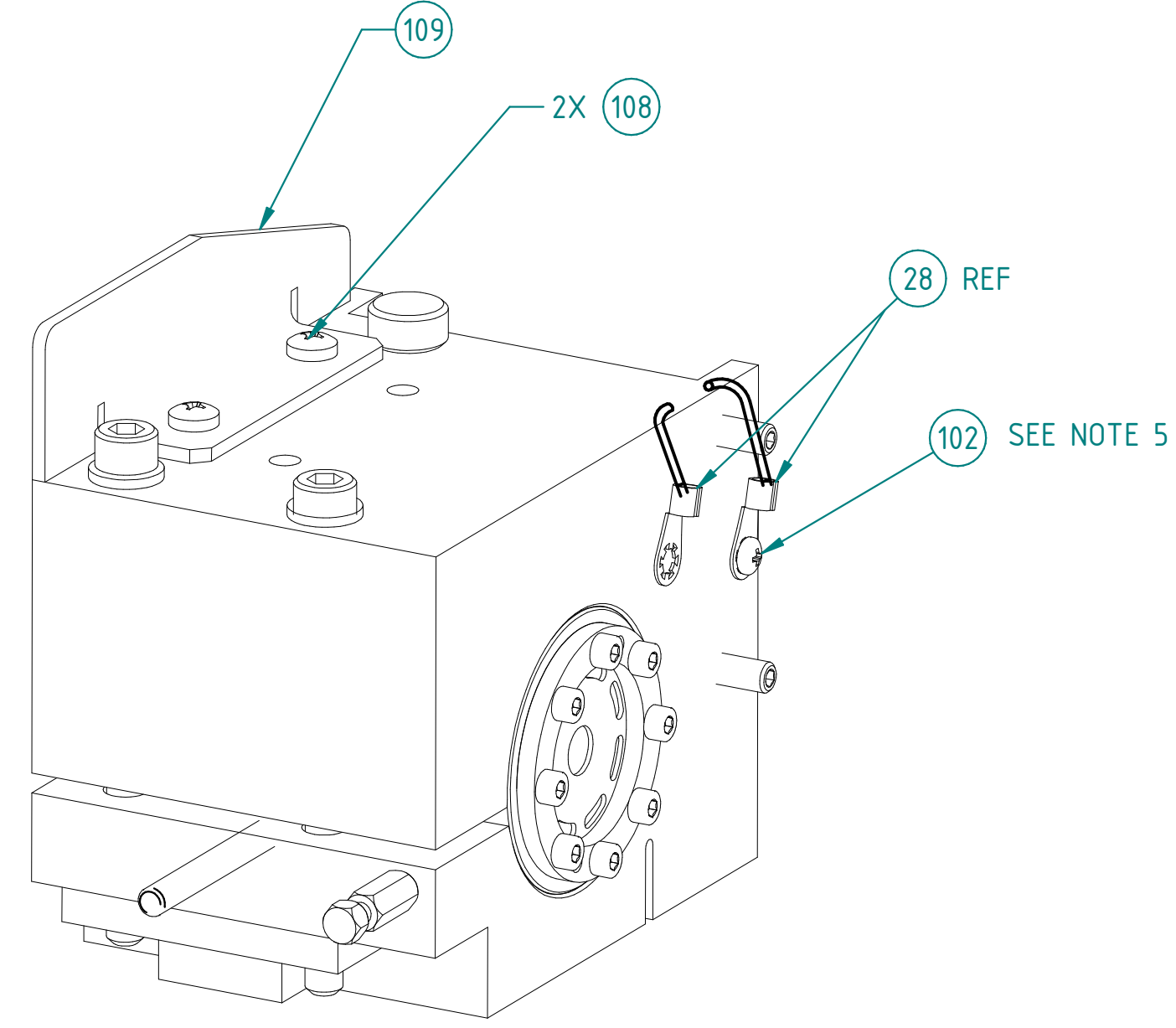

<p>UNLESS OTHERWISE SPECIFIED: DIMENSIONS ARE IN INCHES AND TOLERANCES ARE: 2 PLACE DECIMALS ±.005 3 PLACE DECIMALS ±.0005 4 PLACE DECIMALS ±.00005 ANGLES ±1° FRACTIONS 1/32 SURFACE FINISH</p> <p>GD &amp; T Standard ASME Y 14.5</p> <p>SECONDARY DIMENSIONS ARE PROVIDED FOR REFERENCE ONLY.</p> <p>3RD ANGLE PROJECTION</p>	<p>This PROPRIETARY Document is property of Branson Ultrasonics Corp., Brookfield, CT. It is confidential in nature, non-transferable, and issued with the clear understanding that it is not traced or copied without permission and is returnable upon demand.</p> <p>Article or material must comply with requirements stipulated by RoHS in its current version.</p>	MATERIAL: N/A		<p><b>BRANSON</b></p>	
		Material Spec. N/A		<p>TITLE ACTR MXW 100 SPOT WELD</p>	
		FINISH: N/A		<p>DRAWN ERS 7/09/09</p> <p>CHECKED DAS 7/09/09</p> <p>APPROVED DAS 7/09/09</p>	<p>AGENCY PART NO</p> <p>IPC CLASSIFICATION 3 Important</p> <p>IP CLASSIFICATION NO</p> <p>WEIGHT 35.155 lbm</p>
		Finish Spec. N/A		<p>SCALE: 1:1</p> <p>SHEET 1 OF 4</p>	<p>REV 22</p>

REVISIONS					
ZONE	REV	DESCRIPTION	DATE	ECN/ECO	DRAWN/APPR.
---	---	SEE SHEET 1	---	---	---

- NOTES:
- ALIGNMENT OF ITEMS #14, 15 AND 23 CRITICAL.
  - ALIGN ITEM #21 TO DOWEL PINS #25.
  - THE HOSE 104-109 USED IN THE ASSEMBLY MUST HAVE 11 SEGMENTS.
  - UNLESS OTHERWISE SPECIFIED APPLY LOCTITE 222 TO ALL THREADS ON ASSEMBY, EXCEPT FOR BALLOON 102.
  - APPLY RTV DOW-CORNING 3145, RTV ASI388, DOW CORNING 738 OR EQUIVALENT, ON J2, J4, J6, AFTER SETTING UP THE ACTUATOR.
  - THE DIMENSION OF 0.813in FOR SCREW 203-897 WILL BE FACTORY SET PRIOR TO SHIPMENT.

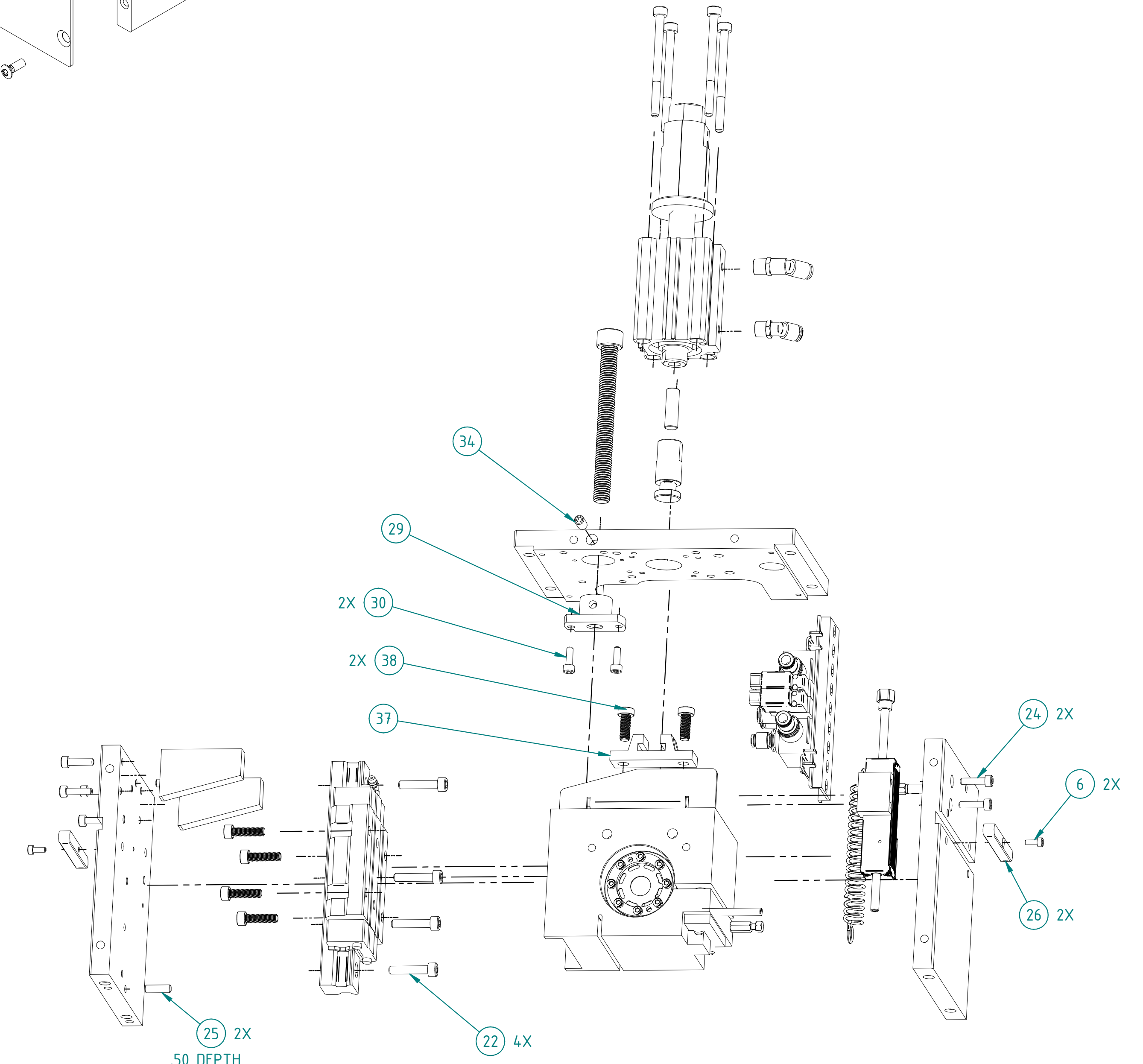
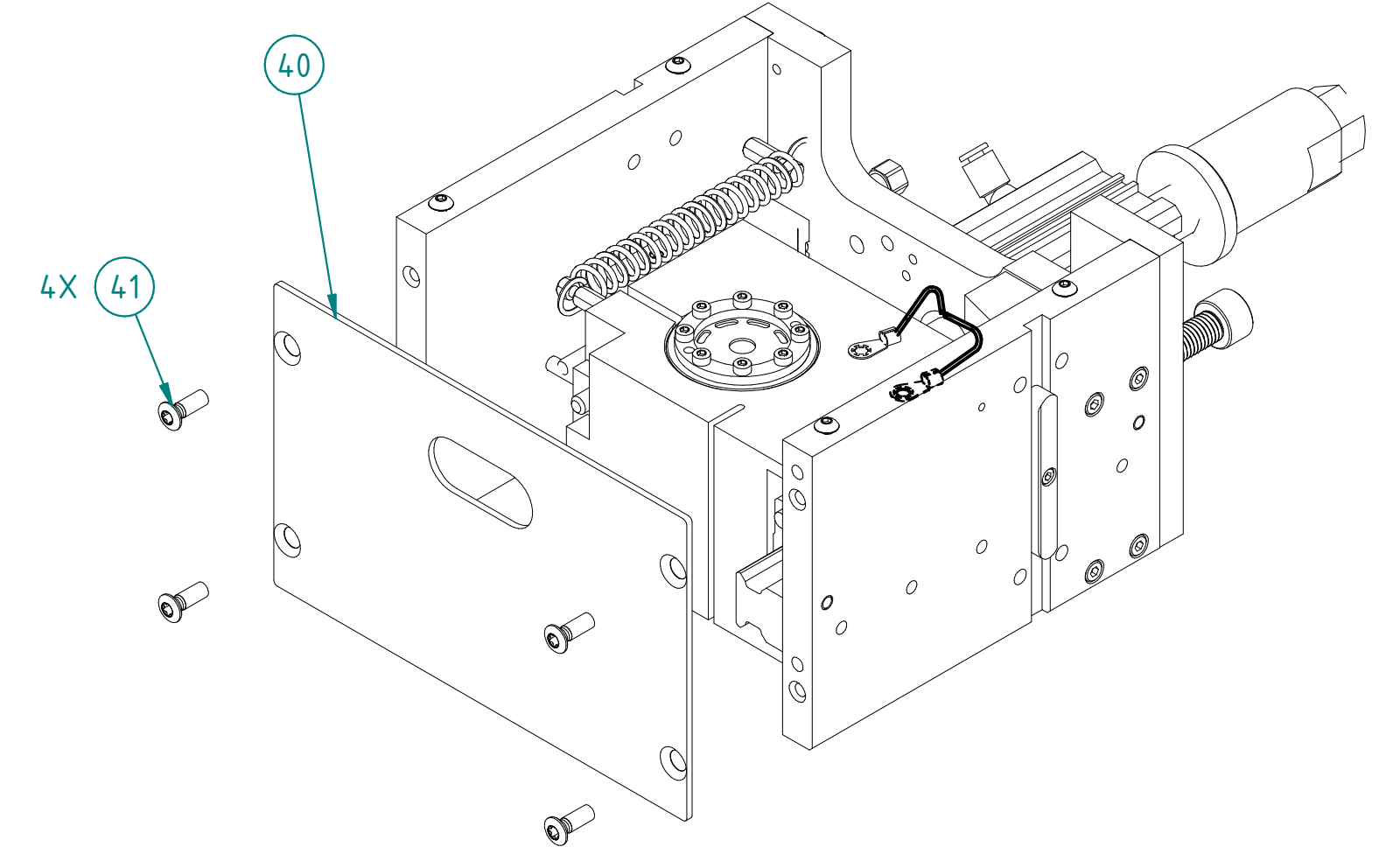
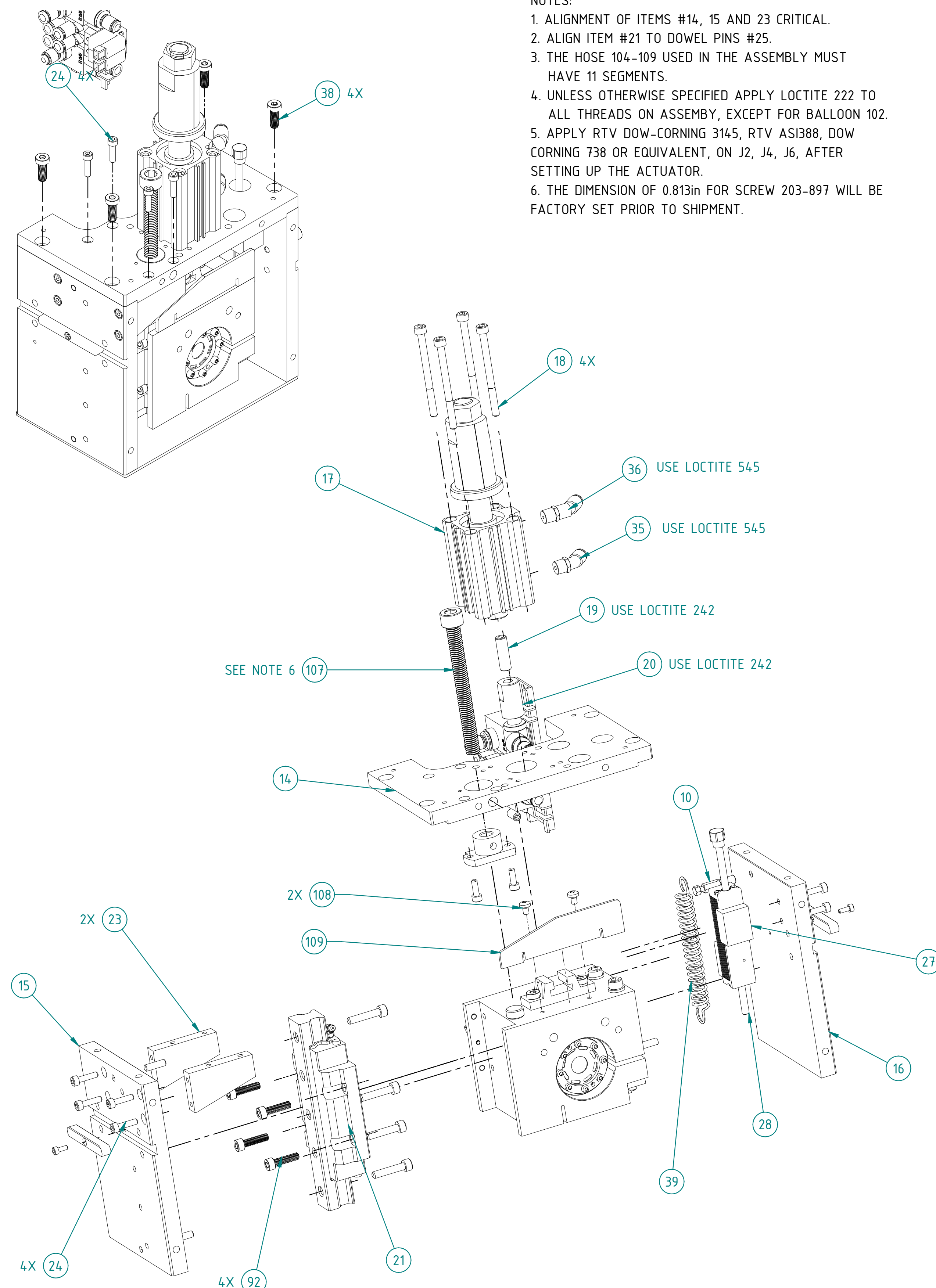

<small>UNLESS OTHERWISE SPECIFIED DIMENSIONS ARE IN INCHES AND TOLERANCES ARE:          2 PLACE DECIMALS ±.015          3 PLACE DECIMALS ±.005          4 PLACE DECIMALS ±.0005          ANGLES ±1° FRACTIONS 1/32 SURFACE FINISH: ▽</small> <b>GD &amp; T Standard ASME Y 14.5</b> <small>SECONDARY DIMENSIONS ARE PROVIDED FOR REFERENCE ONLY</small>	<small>This PROPRIETARY Document is property of Branson Ultrasonics Corp., Brookfield, CT. It is confidential in nature, non-transferable, and issued with the clear understanding that it is not traced or copied without permission and is returnable upon demand.</small> <small>Article or material must comply with requirements stipulated by RoHS in its current version.</small>	MATERIAL: N/A  Material Spec. N/A  FINISH: N/A  Finish Spec. N/A			<b>BRANSON</b>	
			TITLE <b>ACTR MWX 100 SPOT WELD</b>		AGENCY PART NO	BUC CLASSIFICATION 3 Important
<small>3RD ANGLE PROJECTION</small> 			DRAWN ERS 7/09/09	CHECKED DAS 7/09/09	APPROVED DAS 7/09/09	SCALE: 1:2 SHEET 2 OF 4
			NAME ERS	DATE 7/09/09	WEIGHT 35.155 lbm	REV <b>22</b>
			D		159-134-341	22

REVISIONS					
ZONE	REV	DESCRIPTION	DATE	ECN/ECO	DRAWN/APPR.
---	---	SEE SHEET 1	---	---	---

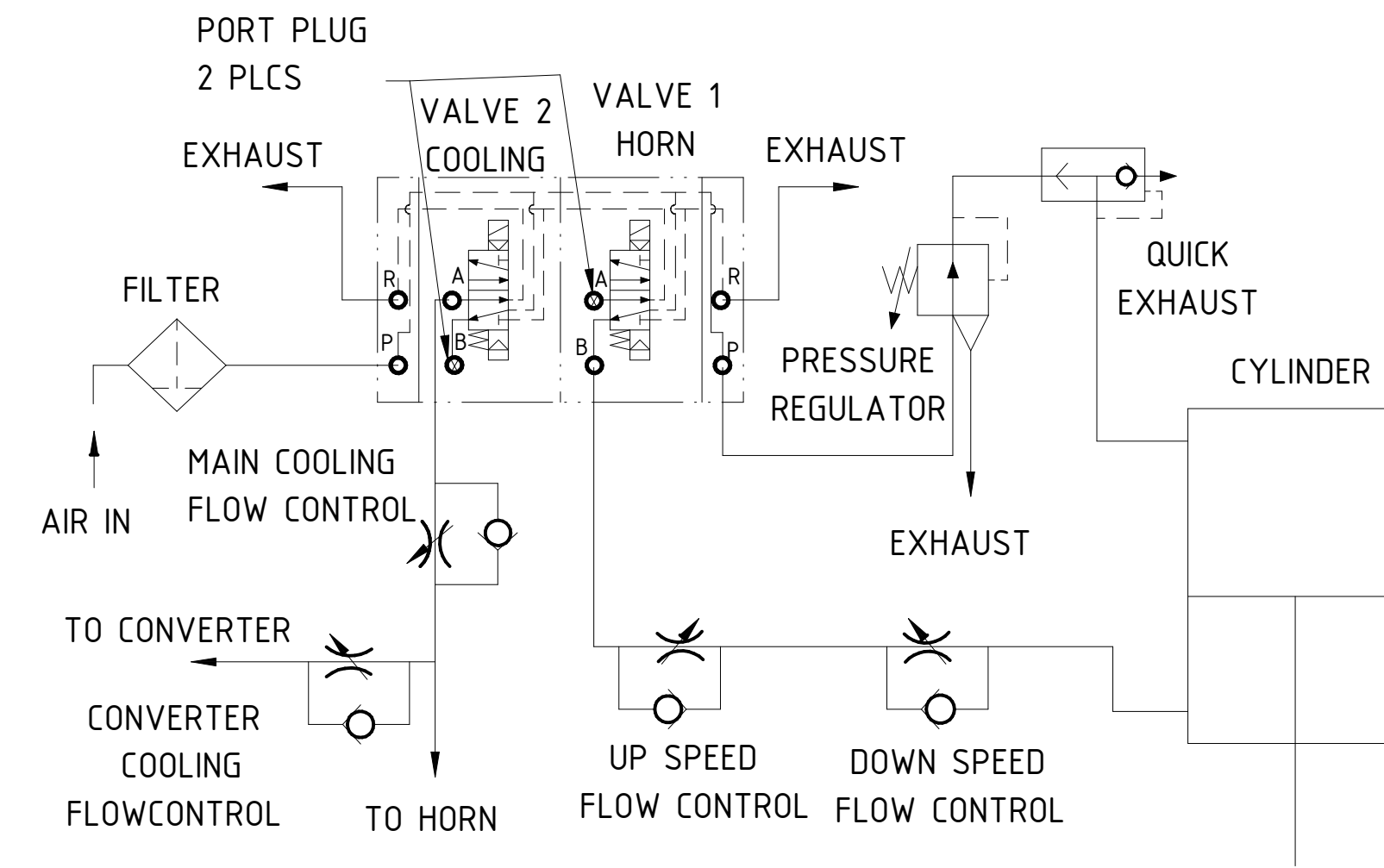
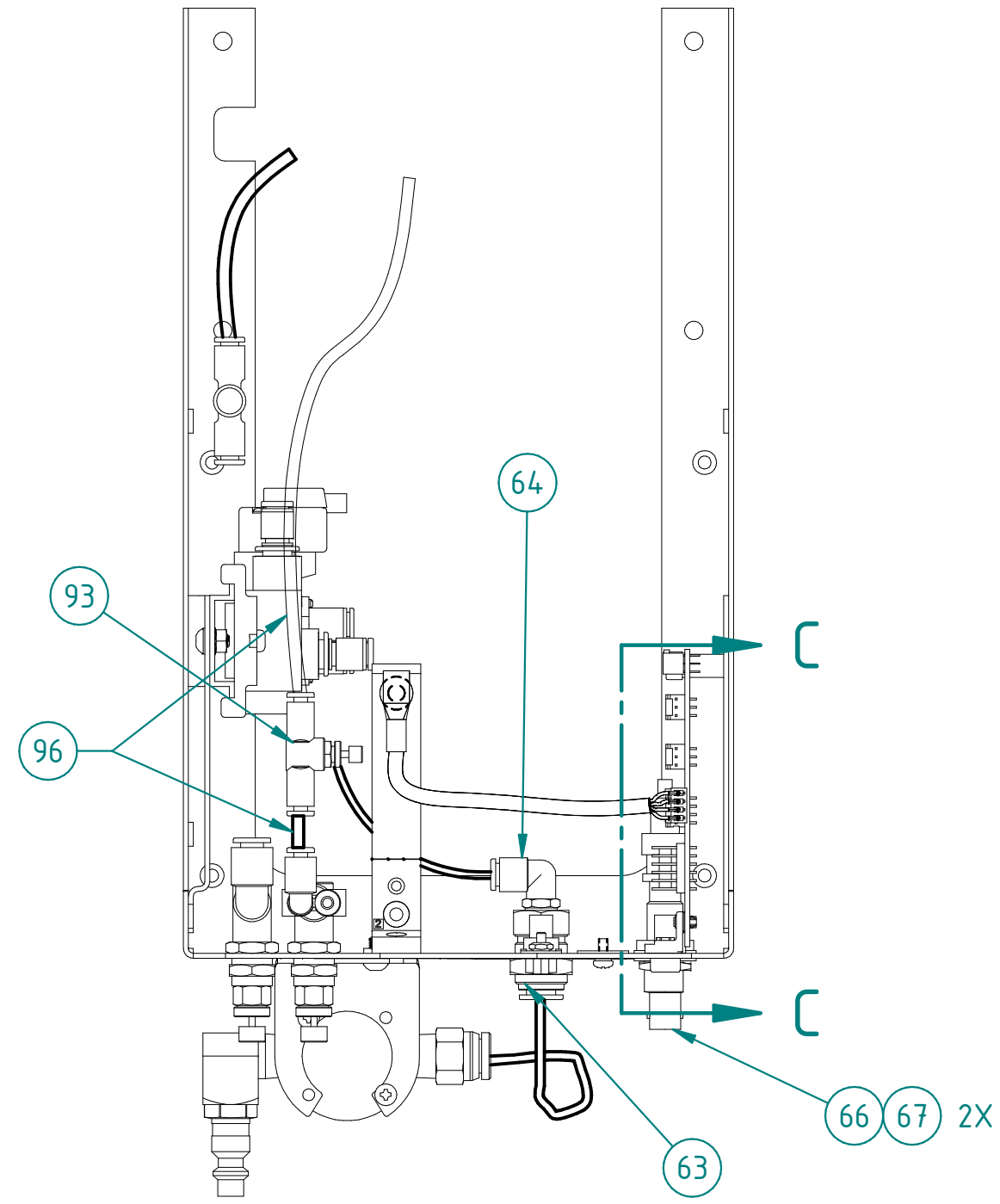
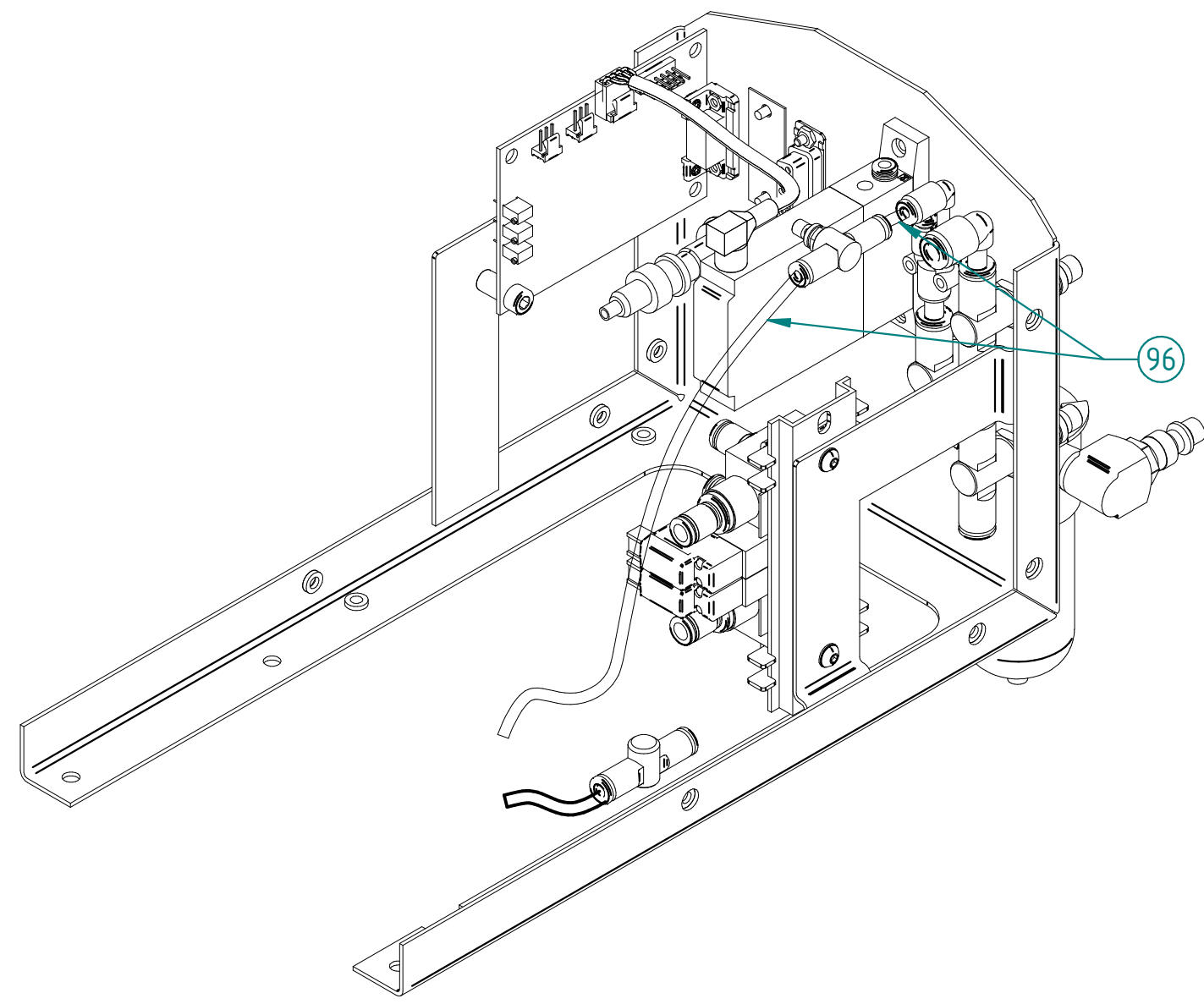

PNEUMATIC DIAGRAM

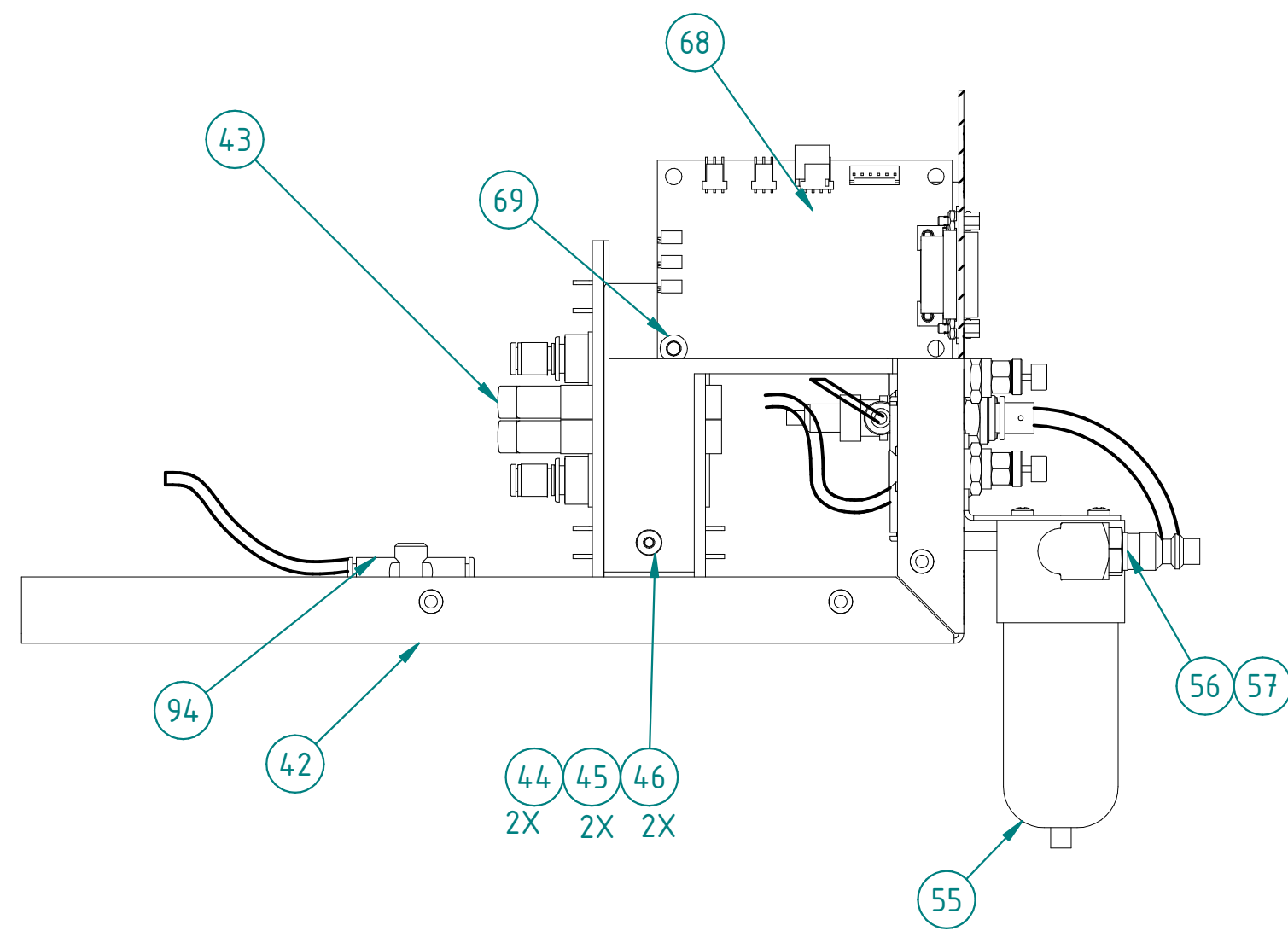

SECTION C-C

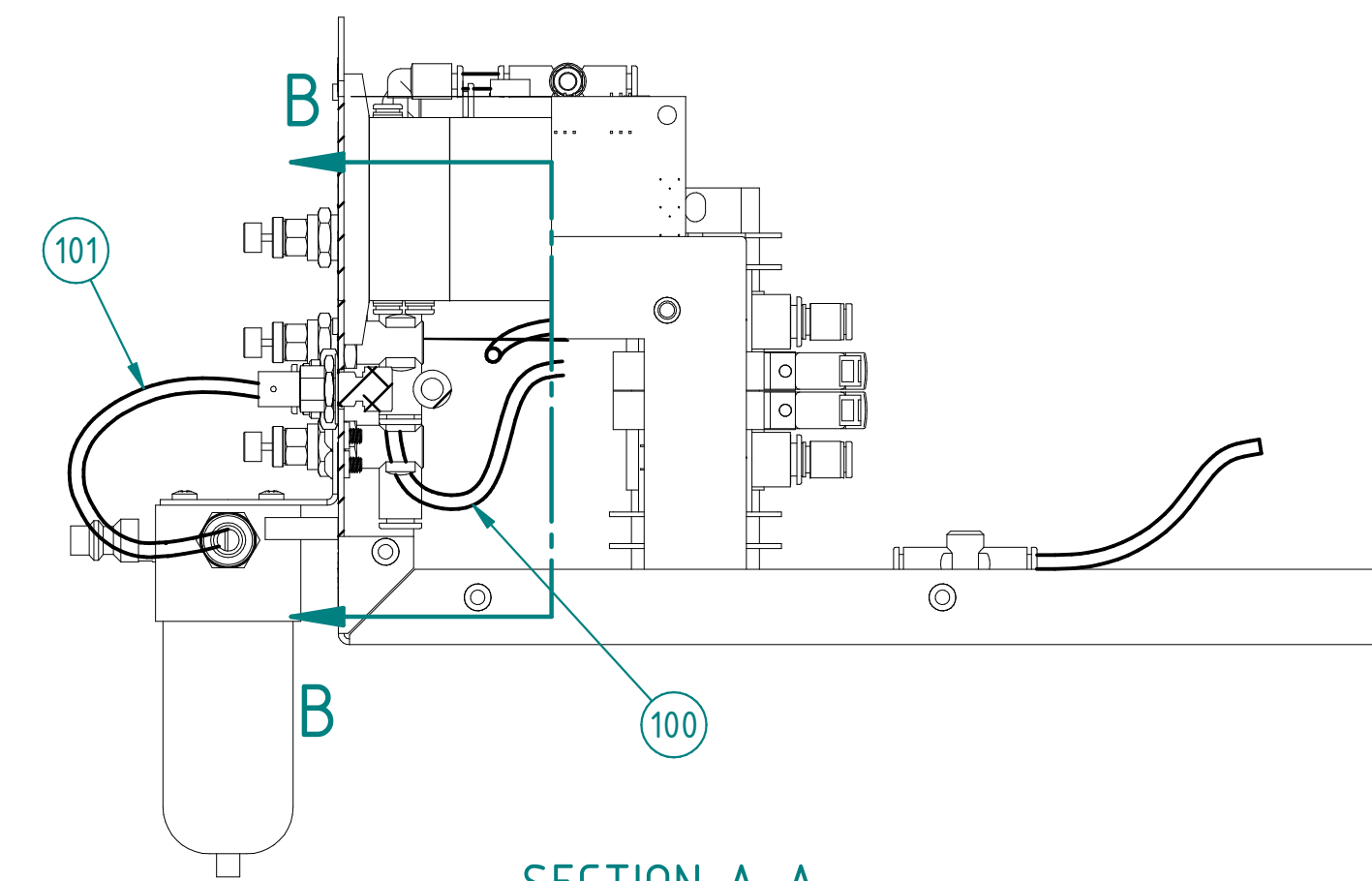
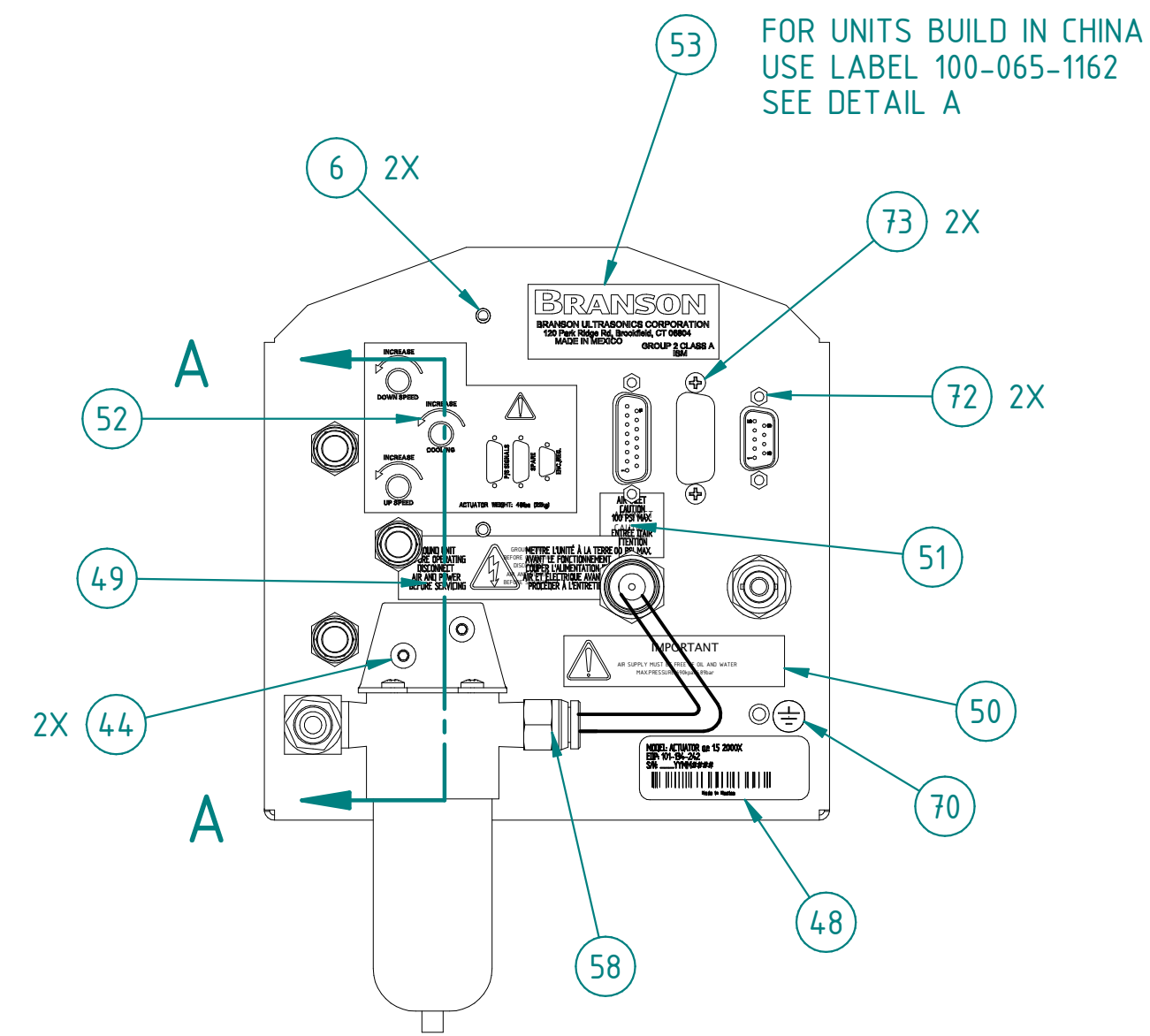

SECTION A-A

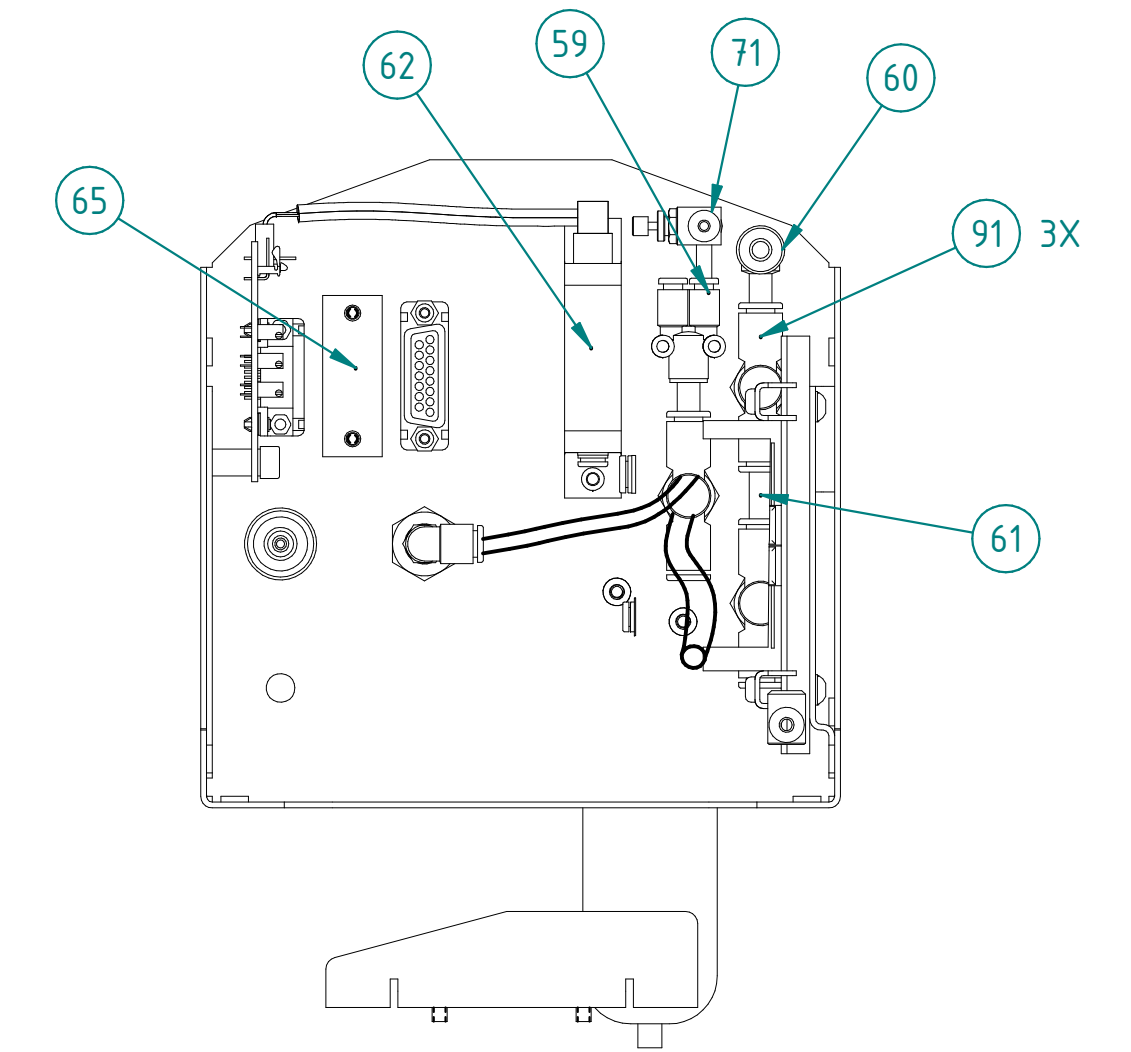

SECTION B-B

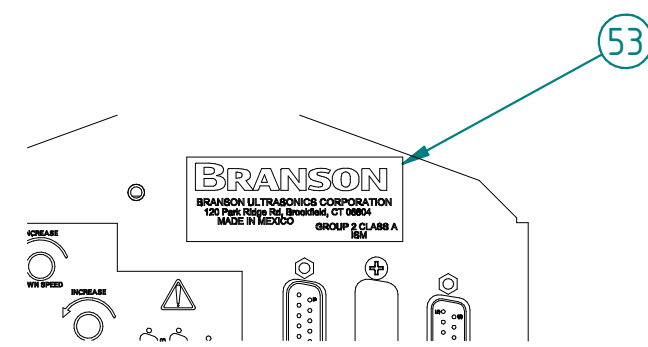

DETAIL A

<small>UNLESS OTHERWISE SPECIFIED DIMENSIONS ARE IN INCHES AND TOLERANCES ARE: 2 PLACE DECIMALS ±0.05 3 PLACE DECIMALS ±0.005 4 PLACE DECIMALS ±0.0005 ANGLES 1/16 FRACTIONS 1/32 SURFACE FINISH</small> <b>GD &amp; T Standard ASME Y 14.5</b> <small>SECONDARY DIMENSIONS ARE PROVIDED FOR REFERENCE ONLY</small>	<small>3RD ANGLE PROJECTION</small> 	<small>This PROPRIETARY Document is property of Branson Ultrasonics Corp., Brookfield, CT. It is confidential in nature, non-transferable, and issued with the clear understanding that it is not traced or copied without permission and is returnable upon demand.</small>  <small>Article or material must comply with requirements stipulated by RoHS in its current version.</small>	MATERIAL: N/A  Material Spec. N/A  FINISH: N/A  Finish Spec. N/A			<b>BRANSON</b>	
				<small>TITLE</small> <b>ACTR MWX 100 SPOT WELD</b>		<small>AGENCY PART</small> NO	<small>3 Important</small> NO
<small>SCALE: 1:1</small>				<small>DRAWN</small> ERS	<small>DATE</small> 7/09/09	<small>CHECKED</small> DAS	<small>DATE</small> 7/09/09
<small>SHEET 3 OF 4</small>				<small>APPROVED</small> DAS	<small>DATE</small> 7/09/09	<small>SIZE DWG NO</small> <b>159-134-341</b>	

REVISIONS					
ZONE	REV	DESCRIPTION	DATE	ECN/ECO	DRAWN/APPR.
---	---	SEE SHEET 1	---	---	---

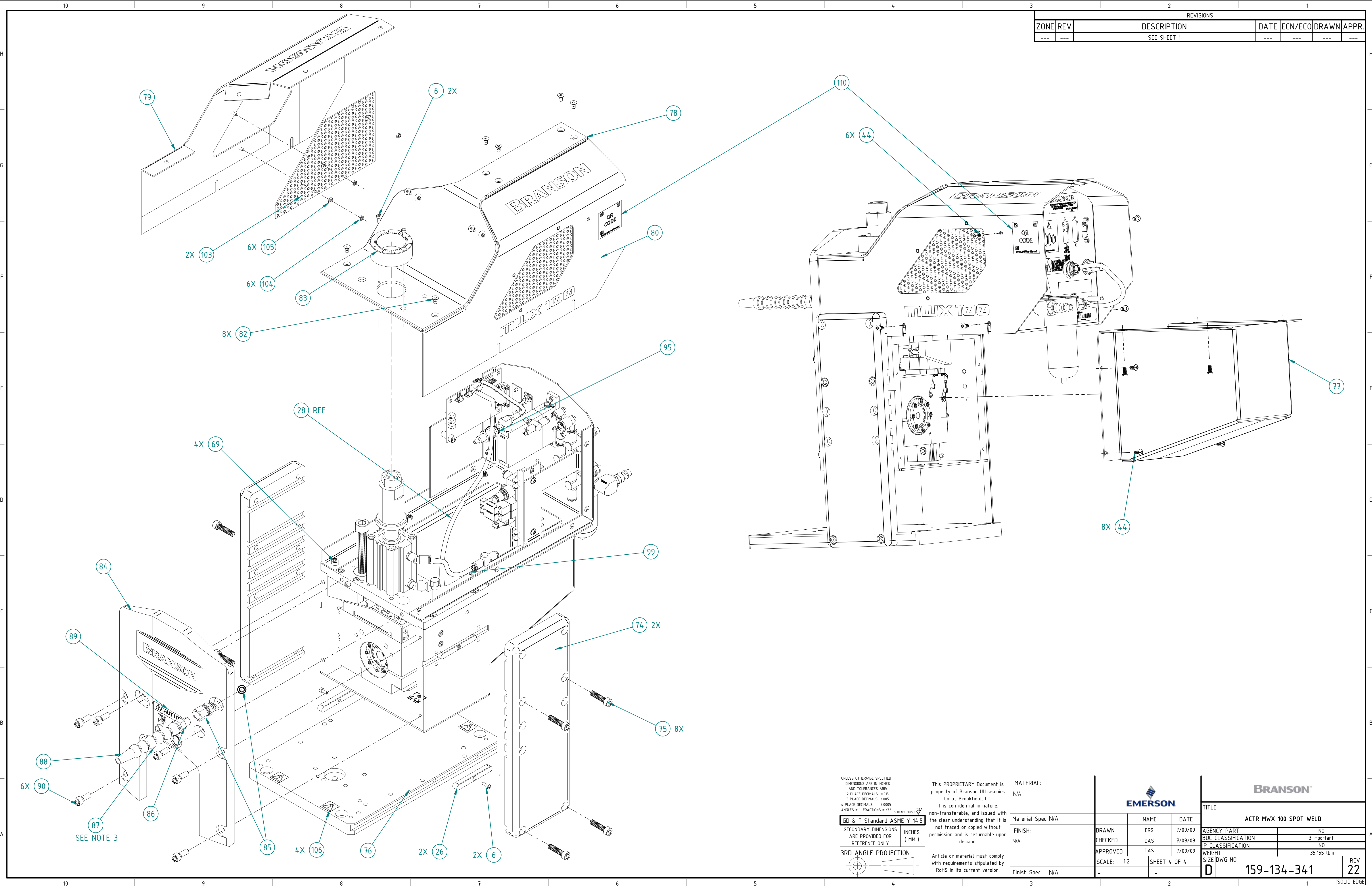

UNLESS OTHERWISE SPECIFIED:  
 DIMENSIONS ARE IN INCHES  
 AND TOLERANCES ARE:  
 2 PLACE DECIMALS ±0.05  
 3 PLACE DECIMALS ±0.005  
 4 PLACE DECIMALS ±0.0005  
 ANGLES ±1° FRACTIONS 1/32 SURFACE FINISH  
 GD & T Standard ASME Y 14.5  
 SECONDARY DIMENSIONS  
 ARE PROVIDED FOR  
 REFERENCE ONLY.

3RD ANGLE PROJECTION

This PROPRIETARY Document is property of Branson Ultrasonics Corp., Brookfield, CT. It is confidential in nature, non-transferable, and issued with the clear understanding that it is not traced or copied without permission and is returnable upon demand.

Article or material must comply with requirements stipulated by RoHS in its current version.

MATERIAL:  
 N/A

Material Spec. N/A

FINISH:  
 N/A

Finish Spec. N/A

EMERSON		
NAME	DATE	
ERS	7/09/09	
DAS	7/09/09	
DAS	7/09/09	
SCALE: 1:2	SHEET 4 OF 4	

BRANSON	
TITLE	
ACTR MUX 100 SPOT WELD	
AGENCY PART	NO
BUCL CLASSIFICATION	3 Important
IP CLASSIFICATION	NO
WEIGHT	35.155 lbm
SIZE/DWG NO	D
159-134-341	REV 22



**EMERSON**<sup>™</sup>

Original Instructions  
DCM00003 - REV. 07

# MWX100 / Ultrasplice Systems

## Instruction Manual

**Branson Ultrasonics Corp.**  
120 Park Ridge Road  
Brookfield, CT 06804  
(203) 796-0400  
<http://www.bransonultrasonics.com>

**BRANSON**

## **Introduction**

This Instruction Set includes common information which relates to Branson products. It will help you in setting up your system and to understand the fundamentals of the ultrasonic metal welding process.

## **Thank You**

Thank you, and congratulations on selecting Branson MWX100/ ULTRASPLICE Systems for your welding production. This system has been developed to produce the highest quality welds at the lowest cost per weld.

If you should experience difficulty or have any recommendations for improvement, please do not hesitate to contact us.

Please be advised that the MWX100/ ULTRASPLICE machine is protected under the United States and International patents listed below. This operator's manual is also protected by copyright and may not be copied without prior written permission by Branson.

## **Trademarks**

MWX100 and ULTRASPLICE are registered trademarks of Branson Ultrasonics Corp.

## **Copyright**

MWX100 Computer Software and the MWX100 Manual are copyrighted 1994, 1995, 1996, 1997 by Branson Ultrasonics Corp.



---

# Table of Contents

---

**Chapter 1: Safety and Support**

1.1	Intended Use . . . . .	2
1.2	Safety, Personal . . . . .	3
1.3	Maintenance Safety . . . . .	4
1.4	Safety, System . . . . .	5
1.5	Contacting Branson . . . . .	6
1.6	Warranty . . . . .	8

**Chapter 2: Introduction**

2.1	Ultrasonic Theory . . . . .	10
2.2	Terminology . . . . .	16

**Chapter 3: Shipping and Handling**

3.1	Unpacking, Handling & Installation . . . . .	22
-----	--	----

**Chapter 4: Troubleshooting**

4.1	Troubleshooting . . . . .	26
4.2	Weld Overload . . . . .	27
4.3	Low Air Pressure . . . . .	28
4.4	Ready Check . . . . .	29
4.5	Troubleshooting Guide . . . . .	30

**Chapter 5: Maintenance**

5.1	Periodic Maintenance . . . . .	34
-----	--------------------------------	----



---

# List of Figures

---

## Chapter 1: Safety and Support

### Chapter 2: Introduction

Figure 2.1	Transforming Electrical Energy into high frequency mechanical vibration . . . . .	10
Figure 2.2	High frequency vibration Welding . . . . .	10
Figure 2.3	Weld 'power graph' (weld footprint). . . . .	12
Figure 2.4	Pressure, Power, and Time relationship . . . . .	12
Figure 2.5	Weld Time . . . . .	13
Figure 2.6	Amplitude. . . . .	13
Figure 2.7	Power, Time, and Energy relationship . . . . .	14
Figure 2.8	Resonant Frequency . . . . .	14

### Chapter 3: Shipping and Handling

### Chapter 4: Troubleshooting

### Chapter 5: Maintenance



---

# List of Tables

---

**Chapter 1: Safety and Support**

**Chapter 2: Introduction**

**Chapter 3: Shipping and Handling**

**Chapter 4: Troubleshooting**

Table 4.1 Troubleshooting Guide . . . . . 30

**Chapter 5: Maintenance**



---

# Chapter 1: Safety and Support

---

<b>1.1</b>	<b>Intended Use</b>	<b>2</b>
<b>1.2</b>	<b>Safety, Personal</b>	<b>3</b>
<b>1.3</b>	<b>Maintenance Safety</b>	<b>4</b>
<b>1.4</b>	<b>Safety, System</b>	<b>5</b>
<b>1.5</b>	<b>Contacting Branson</b>	<b>6</b>
<b>1.6</b>	<b>Warranty</b>	<b>8</b>

## 1.1 Intended Use

This equipment is for the joining of metal parts using ultrasonic energy. A complete system includes an actuator, controller and tooling (which delivers mechanical energy to the work pieces). Some systems also include special fixturing and machine automation. Branson systems may only be utilized to weld soft, ductile, metal parts together with Branson-supplied weld tooling (such as horns, tips, anvils, and converters) unless an explicit, written, contrary agreement between the ordering party and Branson has been consummated.

## **1.2 Safety, Personal**

### **1.2.1 Safety Devices**

The removal, bridging or disabling of safety devices is not condoned for production operation. Individual safety devices mentioned below may only be disabled if super-ordinate safety devices are employed in their place.

### **1.2.2 Emergency Stops**

In case of danger, hit the red, emergency stop which is found on the red, top portion of the foot pedal. The actuator, power supply and related fixturing are returned to the "Home" position. If dual anti-tie start buttons are used, there must be a red emergency stop associated in line. Free access to the emergency stop button must be maintained.

### **1.2.3 Controller Cover**

The power supply is equipped with a top cover which should only be removed for maintenance and installation purposes.

### **1.2.4 Safety Guidelines**

For operating safety, please observe the following precautions:

- Plug the power supply into a grounded electrical supply to avoid electrical shock
- Ensure that no one is in contact with system moving parts when operating
- Keep hands away from the horn tip as high force and ultrasonic vibration can cause injury to hands and fingers
- Do not test ultrasonics when the converter is removed from the actuator. Without the converter there is the danger of damage or shock
- Before adjusting or repairing the ultrasonic stack or power supply, disconnect the line power
- Any unauthorized modification of the units control circuitry or wiring may cause a malfunction, which could result in injury to operating personnel
- Do not operate the equipment until repairs and adjustments have been made and the equipment is in good working order

## 1.3 Maintenance Safety

Safety devices, especially covers, guards and ground cables should only be removed when it is absolutely essential for the completion of maintenance work. If safety devices were removed prior to starting maintenance work, be sure to re-install those devices after finishing the maintenance work. The following installation and maintenance operations must be performed prior to any disassembly of equipment:

- All system components must be disconnected from the main electrical supply
- Remove the plug from the main electrical supply and secure it from being re-inserted accidentally
- All system components must be disconnected from the main air supply
- Disconnect the air hose from the main air supply and release system air pressure via the pressure regulator

## **1.4 Safety, System**

### **1.4.1 System Protection Monitoring (SPM)**

The SPM (System Protection Monitoring) stops ultrasonics when the power supply has been overloaded or when inappropriate or defective horns are used.

### **1.4.2 Thermal Switch**

A thermal switch is contained within the power supply to automatically disconnect power to the machine if the unit gets too hot. This will occur if the exhaust fans from the generator are inadvertently blocked or clogged.

### **1.4.3 Daily Functional Safety Checks**

- Check the machine tip and anvil for any signs of grinding, cracking, or galling that could be the result of misalignment or tooling contact. Replace tooling that has excessive wear
- Check for any loose material or debris in the welding cavity, cleaning it out
- Check all parameter settings on the controller to ensure they are properly set for the weld to be made
- Drain water and contaminants from the airline filters as necessary

## 1.5 Contacting Branson

### 1.5.1 Spare Parts & Replacement Tooling

Spare parts or replacement tooling for the ultrasonic welding system may be ordered directly from Branson. A spare tooling specification sheet is included in the Special Information Instruction Set. Additional part listings are contained in the Actuator and Touchscreen Controller Instruction Set sections of this manual.

Branson will work with you and recommend components you need and should carry in inventory based upon your manufacturing philosophy and or production needs. We will quote price, delivery and can coordinate special arrangements such as expedited service or blanket orders.

When Ordering Spare or Replacement Parts, have the purchasing agent Fax the order to us with the following information provided:

- Purchase Order Number,
- Branson Part Number, Quantity, and Date Required,
- Ship To Information, (including "Ship to the Attention of")
- Bill To Information
- Shipping Instructions, (such as air freight, truck, etc.)
- Special Instructions, (such as "Hold at Pick-Up Counter and Call" -- Be sure to provide a name and a phone number)

### 1.5.2 Questions or Problems

If you have any questions or are experiencing a problem, call the local Branson field sales and/or service representative. He or she will be familiar with your equipment and application and, in most cases, will be able to help you. He or she may have the replacement part you need, in stock, that will return your system to operation in the shortest possible time.

If necessary, the representative will contact Branson for additional service and, in some cases, will put you into contact with the appropriate personnel. If the local representative is unavailable, please call us directly.

#### **Before you call, take the following steps:**

- Have this manual with you
- Know how your system has been set up and equipped, including your MBOS version
- Be able to describe the situation or problem
- Have a list of steps that you have already taken
- Have a list of spare parts in your inventory
- Have the name and phone number of the Local Branson Representative

## 1.5.3 Returning Equipment

In order to properly and efficiently handle an equipment return to Branson, the following procedure must be followed. Contact your Local Sales Manager or Branson Customer Service for assistance. Proper handling and identification of your equipment will expedite servicing and/or return.

Call Branson and Receive a Return Authorization Number (RA#) from Branson Customer Service.

- Properly package the equipment to prevent damage
- Clearly mark the RA# on the outside of the package
- Include a copy of the completed Return Authorization Form inside the package
- Return general repairs by any convenient method. Send priority repairs via Air Freight
- Prepay the transportation charges, (FOB Brookfield, CT)

Complete the following in the Return Authorization Form:

- Customer Information Section
- Description of Problem
- Equipment Information

## 1.5.4 New Applications

Branson is always eager to work with you on a new ultrasonic application. Whether it be a manual workstation, a semi or fully automated system, Branson has the personnel and technical competence to support your requirements. Branson's application laboratory, product and automation engineering, customer service and manufacturing capabilities are second to none. Branson is the world leader in ultrasonic metal welding and our business philosophy is practiced to assure customer success.

Application assistance is always available. For initial application review, contact your Local Sales Manager who can indicate initial feasibility and assist you in completing an Ultrasonic Weld Evaluation Request For. Please complete one (1) request form for each application.

Please fill out the Ultrasonic Evaluation Request Form, complete the customer and application information section and forward it to Branson along with enough component material to produce 24 assemblies, (if this is not practical please advise). A feasibility evaluation will be performed and samples returned, for review, along with a system quotation/ proposal. Be sure to include drawings of the completed assembly and include the electrical, mechanical, and production requirements. Complete the form as completely as possible. The Branson Sales Representative can assist you.

## 1.6 Warranty

For warranty information please reference the warranty section of Terms and Conditions found at: [www.emerson.com/branson-terms-conditions](http://www.emerson.com/branson-terms-conditions).

---

## **Chapter 2: Introduction**

---

<b>2.1</b>	<b>Ultrasonic Theory</b> .....	<b>10</b>
<b>2.2</b>	<b>Terminology</b> .....	<b>16</b>

## 2.1 Ultrasonic Theory

### What Is An Ultrasonic Weld?

Ultrasonic welding joins metal parts by applying the energy of high frequency vibrations onto the interface area between the parts to be welded.

### How Does It Work?

Electrical Energy is transformed into high frequency mechanical vibration. This mechanical vibration is transferred to a welding tip through an acoustically tuned horn ([Figure 2.1](#)). The parts are "scrubbed" together under pressure at 20,000 or 40,000 cycles per second. This high frequency vibration, applied under force, disperses surface films and oxides, creating a clean, controlled, diffusion weld ([Figure 2.2](#)). As the atoms are combined between the parts to be welded, a true, metallurgical bond is produced.

**Figure 2.1** Transforming Electrical Energy into high frequency mechanical vibration

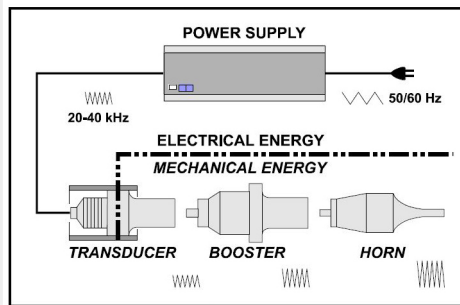

**Figure 2.2** High frequency vibration Welding

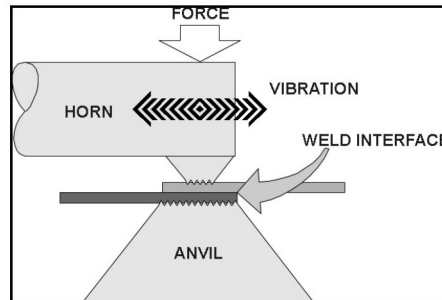

### Benefits of Ultrasonic Welding

Ultrasonic metal welding exhibits unique welding properties that include:

- Excellent electrical, mechanical, and thermal connections between similar and dissimilar metals
- Low heat build up during the ultrasonic process (no annealing of materials)
- Compensation for normal surface variations of the material
- Ability to clean surface oxides and contaminants prior to welding
- Ability to weld large areas using minimal energy
- Ability to weld thin materials to thick materials
- Low cost per weld

### How Is An Ultrasonic Weld Made?

Although the theoretical process of producing an ultrasonic weld is uncomplicated, the interactions of the various weld parameters are important and should be understood.

When producing an ultrasonic weld, there are three primary variables that interact; they are:

**Time:** The duration of applied ultrasonic vibration

**Amplitude:** The longitudinal displacement of the vibration

**Force:** The compressive force applied perpendicular (normal) to the direction of vibration.

Power required to initiate and maintain vibration (motion) during the weld cycle can be defined as:

$$P = F \times A$$

Where:

- P = Power (watts)
- F = Force \* (psi)
- A = Amplitude (microns)

NOTICE	
	<p>Force is determined by multiplying:            Force = (Surface Area of the Cylinder) X (Air Pressure) X (Mechanical Advantage)</p>

Energy is calculated as:

$$E = P \times T$$

Where:

- E = Energy (joules)
- P = Power (watts)
- T = Time (seconds)

Thus the complete 'Weld To Energy' process would be defined as:

$$E = ( F \times A ) \times T$$

A well designed ultrasonic metal welding system will compensate for normal variations in the surface conditions of the metals by delivering the specified energy value. This is achieved by allowing Time (T) to adjust to suit the condition of the materials and deliver the desired energy.

### **Welding To Energy - Why?**

Most metal welding applications are produced by 'Welding To Energy' in order to compensate for the various surface oxides and contaminants associated with the metals being joined. In a few applications 'Welding To Time' or 'Welding To Height' will yield better results. Since the majority of all metal welds are produced using energy as the controlling factor we will confine our discussion to that condition.

Welding to energy is necessary because of the non-metallic oxides that form on the metal's surface as well as other contaminants such as grease and dirt. To producing quality welds reliably it is necessary that the surfaces to be joined are clean. The high frequency scrubbing action, combined with pressure, cleans the weld interface at the beginning of the weld process.

The following graph ([Figure 2.3](#)) illustrates a weld produced. The weld 'power graph' is sometimes referred to a weld 'footprint'. It can be used to visualize the weld cycle and assists in parameter optimization. Graphs from consecutive welds will vary slightly as the system dynamically adjusts time to accommodate varying surface conditions. The weld power data is gathered by sampling the power used in 5 millisecond intervals.

## Power

The converter/ booster/ horn, (stack assembly), requires minimal electrical power to initiate and maintain motion (vibration) at a 'no-load' condition. As the mechanical load increases, the power required to maintain the mechanical vibration also increases. The maximum power required during a weld cycle is 'Peak Power'.

**Figure 2.3** Weld 'power graph' (weld footprint)

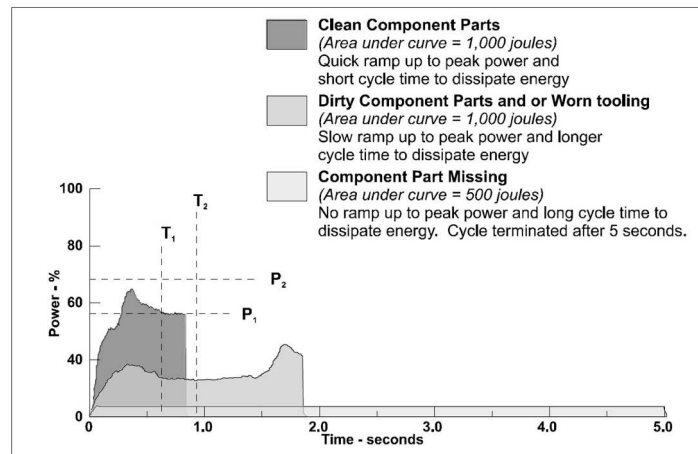

By increasing Pressure and maintaining all other parameters, the mechanical load or force on the weld joint increases, therefore, the amount of Power required to maintain the vibration of the stack increases. Subsequently, because of the increased Power Level, less time is required to deliver the same amount of Energy. This relationship is illustrated in the following diagram ([Figure 2.4](#)):

**Figure 2.4** Pressure, Power, and Time relationship

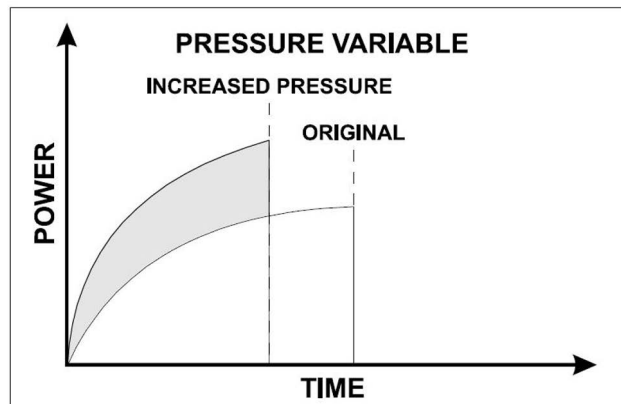

The difference in the appearance of each of the above weld graphs is the result of increased Power loading. Based upon an increase in Pressure, additional Power is required to maintain the motion of vibration. Thus, the same amount of energy is delivered in less time. This approach is typically used to raise the loading of the power supply during a weld cycle to the desired level as determined by the application.

## Time

The time required to deliver the necessary energy is defined as the Weld Time. For most welds, the time required will be less than one second. If more energy is required and all other weld parameters are maintained, the weld time will increase ([Figure 2.5](#)).

**Figure 2.5** Weld Time

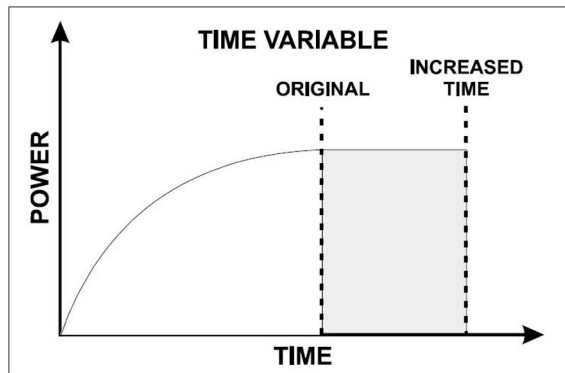

## Amplitude

An ultrasonic tool is a resonant acoustical device. The term Amplitude is used to describe the amount of longitudinal expansion and contraction that the tooling endures as it vibrates ([Figure 2.6](#)). The amplitude correlates to the scrubbing action at the weld interface. This scrubbing action combined with pressure is what advances the weld by a diffusing or mixing of the base materials.

**Figure 2.6** Amplitude

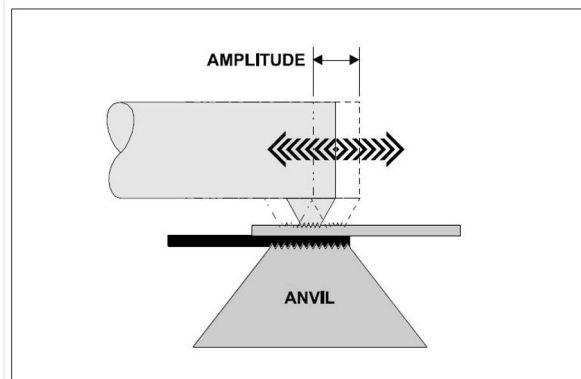

As previously mentioned, the converter/ booster/ horn, (stack assembly), requires minimal electrical power to initiate and maintain vibration in a 'no-load' condition. As the amplitude increases, the power required to maintain the increased velocity of vibration also increases.

Subsequently, because of the increased Power less time is required deliver the same amount of Energy. This relationship is illustrated in the power diagram ([Figure 2.7](#)):

**Figure 2.7** Power, Time, and Energy relationship

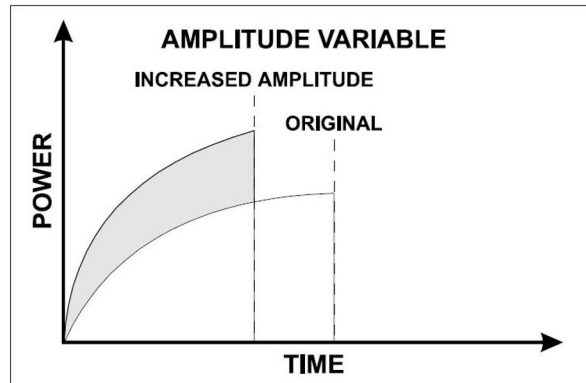

## Resonant Frequency

The ultrasonic tooling acts as a spring having node points and anti-node points. The mechanical energy used to vibrate the tool is created by the converter. As the vibrations are propagated through the acoustical tool, a harmonic resonance is established consisting of nodes and anti-nodes. This action results in a resonant wave being transferred through the tooling ([Figure 2.8](#)). The efficiency of the resonant wave transfer depends on the natural resonant frequency of the horn and is determined by two factors:

- The speed of sound through the material
- The geometric shape of the object

**Figure 2.8** Resonant Frequency

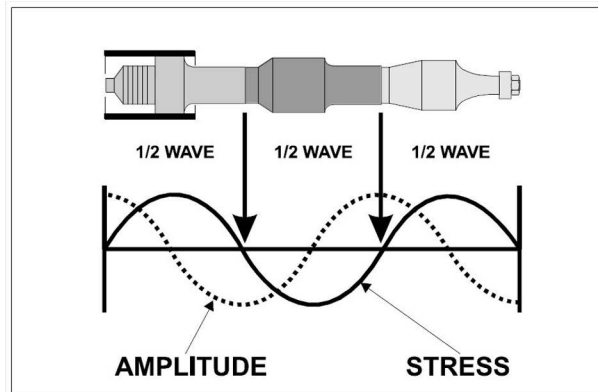

**Avoiding An Overload Condition:** It is possible to increase the Amplitude and or the Pressure to a point where the power available is not adequate to initiate or maintain vibration under the given mechanical load. At this point, the power supply will stall resulting in an Overload condition. Electronic circuits in the system will protect the power supply if this condition exists.

**Welding To Time:** In specific applications, 'Welding To Time' may be desired. As previously mentioned, there are three primary variables that interact; they are:

- **TIME:** The duration of applied ultrasonic vibration
- **AMPLITUDE:** The longitudinal displacement of the vibration
- **FORCE:** The compressive force applied perpendicular (normal) to the direction of vibration

Generally, welding for a specific time will produce acceptable results when:

- The equipment is installed on an automated production line and each station must complete its process within a certain time limit
- Very small low energy welds on clean components are being made

**Welding Temperature:** Ultrasonic welding produces a localized temperature rise from the combined effects of elastic hysteresis, interfacial slip and plastic deformation. The weld interfaces reach approximately 1/3 the temperatures needed to melt the metals. Since the temperature does not reach the melting point of the material, the physical properties of the welded material are preserved. As the ultrasonic welding process is an exothermic reaction, as welding time increases so does weld temperature.

## 2.2 Terminology

**Actuator:** A mechanical device which houses the converter/booster/horn (stack) assembly in a rigid mounting and is utilized to move the stack up or down. This allows for precise control of welding pressure for efficient while delivering mechanical vibrations from the ultrasonic stack to the work piece(s).

**After Burst:** A short duration (burst) of ultrasonic energy that begins after completion of the AFTER BURST DELAY. (Also See: AFTER BURST DELAY & AFTER BURST DURATION).

**After Burst Delay:** The amount of time, in seconds, between the completion of the ultrasonic welding cycle and the start of the AFTER BURST. (Also See: AFTER BURST & AFTER BURST DURATION).

**After Burst Duration:** The amount of time, in seconds, that AFTER BURST energy is delivered. (Also See: AFTER BURST & AFTER BURST DELAY).

**Amplitude:** Amplitude is the peak-to-peak displacement of mechanical motion as measured at the face of the horn tip. Amplitude is measured in thousandths of an inch or in microns. (i.e. A standard 40 kHz converter produces approximately .0004" or 10 microns of amplitude), Inches x 25,400 = microns. -- With 'Advanced Power Supply' this is adjustable depending on system frequency and application tooling.

**Anti-Node:** The anti-node is the area of the horn and booster that exhibits maximum longitudinal displacement and where the internal dynamic forces are equal to zero. This area is at the face and back surface on half-wave technology.

**Anvil:** A device specially designed to grip the lower component and hold it stationary against the energy of vibration(s) which allows a weld to be created.

**Baud Rate:** A communications measure describing the speed at which signals are transmitted serially (the number of signal events per second).

**BBRAM:** Nonvolatile random access memory (battery back-up random access memory). Equipped with long life built in batteries, this memory area preserves weld parameters and menu settings when the system is powered off. (also known as BBR).

**Booster:** The central component of an ultrasonic stack assembly. A device which transfers mechanical energy from the converter to the ultrasonic horn. The booster will, depending on design, increase, decrease, or maintain the specific energy (amplitude) as received from the converter.

**Calibration:** The process of adjusting a device to a known position for purposes of inspection and/or monitoring position, direction, speed, and/or velocity.

**Clock:** An electronic circuit that generates timing pulses to synchronize the operations of various other circuits in a device(s).

**Communications:** Transmission of information between points of origin and reception without alteration of the sequence and or structure of that information content.

**Consumable Spare Tooling:** The tooling portion of the ultrasonic system that wears and requires replacement due to production use. This includes but is not limited to ultrasonic horns, replaceable tips, anvil, and positioning mask. A Spare Tooling Specification Sheet is included within the Operation Manual to document the spare tooling for a specific metal welding application.

**Continuous Sonics Mode:** A system setting in which the power supply will deliver ultrasonic electrical energy until the start signal is terminated.

**Controller:** The portion of the welding system that provides specific settings & instruction(s) to the overall welding system.

**Converter:** A device which utilizes a lead-zirconate-titanate electrorestrictive element to change high frequency electrical energy into high frequency mechanical energy.

**Counter:** A programmable device used to monitor system cycles and alert personnel when specific conditions are met.

**Data:** Any representation(s) of instructions, characters, information, or analog quantities to which meaning may be assigned.

**Default:** A chosen system setting or parameter in which the system does not require external data input. In some cases the default value will be changed based upon equipment use.

**Dynamic Spring:** An, adjustable, energy storage mechanism (shock absorber) which allows for stack follow through upon engagement of application tooling with the work pieces to be welded.

**Energy:** Energy is the area beneath the ultrasonic power curve and is calculated in joules, (Watts X Seconds = Joules). When the ultrasonic welding system is setup in the "Weld In Energy" mode the system will deliver the amount of energy as programmed. **NOTE:** The maximum (default) time allowed for delivering ultrasonic energy is five (5) seconds.

**Energy Mode:** A welding method in which the ultrasonic power supply is active until the required amount of energy is delivered (See ENERGY).

**Fixture:** A device for positioning and or holding a component for assembly.

**Force:** The amount of mechanical pressure that is used to deliver, (bring down) the mechanical actuator. This programmed force is also called TRIGGER FORCE and is used to engage the knurl pattern into the component part(s) prior to the initiation of ultrasonic energy.

**Frequency:** The number of complete oscillations per second expressed in Hertz (Hz) or kilohertz (1 kilohertz = 1000 Hz). Typically 20 kHz or 40 kHz.

**Gain:** The ratio of the amplitude of motion produced by the converter and delivered by the horn is called the gain. It is determined by the difference in mass on either side of the nodal point.

**Hand Shaking:** The procedure (signal exchange) when a connection is established between two electronic devices. A common example is the signal exchange between a terminal and a MODEM. These signals (hardware and software) are used to control the flow of data (start/stop) between devices.

**Height:** A display value, in millimeters (mm), as registered by a linear encoder upon completion of an ultrasonic welding cycle. -- Programmable, in millimeters, with Upper Control Limit & Lower Control Limit.

**Height Encoder:** A device utilized to monitor position, direction, speed, and/or velocity.

**Horn:** An acoustically designed metal tool that delivers mechanical energy from the converter/ booster into the work piece. Most applications utilize half wave technology, (40 kHz = 2.2" ±, 20 kHz = 5.5" ±).

**Hold Time:** The amount of time after delivery of ultrasonic energy until the stack tooling begins to retract from the component material(s).

**Joint:** The welded surfaces.

**Linear Height Encoder:** (See: Height Encoder).

**Loading Meter:** A meter which indicates the power drawn from the ultrasonic power supply.

**Maintenance Counter:** A programmable device used to alert production personnel of the need to review / inspect application tooling and/or the ultrasonic system for preventive maintenance purposes. The device increments one (1) count for each system cycle. (See: Counters).

**Mode:** The method of operating the system (also see WELDING MODE).

**Node:** The node is the area of the horn, (and booster), that exhibits no longitudinal displacement and where the internal dynamic forces are at the maximum. This area is in the center location on half-wave technology.

**Parameter(s):** Programmable units used to control and or monitor the ultrasonic process. -- Include but not limited to ENERGY, FORCE, PRESSURE, AMPLITUDE.

**Parts Counter:** A programmable device used to monitor system cycles and alert personnel when specific conditions are met. (See: Counters).

**Peak Power:** Peak power is the maximum amount of power in watts that was required to keep the ultrasonic stack in motion during the weld cycle.

**Power:** Power, measured in watts, is a function of pressure and amplitude. The amount of power, (watts) required to keep the ultrasonic stack in motion is monitored and used to develop a power curve. This power curve is used to calculate the amount of energy delivered/ dissipated, (Watts = Joules / Time). The power as displayed on the control box is peak power.

**Power Supply (Ultrasonic):** An electronic device that converts 50/60 cycle electrical current into 40 kHz, (40,000) or 20 kHz, (20,000) cycles per second high frequency electrical energy.

**Power Supply Overload (Ultrasonic):** The point or limit at which the amount of power in watts, required to keep the ultrasonic stack in motion, exceeds the available power from the power supply. The system will go into an overload condition in order to prevent system damage.

**Preheight:** A pre-sonic inspection display, in millimeters (mm), as registered by a linear encoder prior to initiation of the ultrasonic welding cycle. -- Programmable, in millimeters, with Upper Control Limit & Lower Control Limit.

**Presets:** System memory available for storage and retrieval of welding parameters.

**Pressure:** The amount of mechanical pressure supplied to the ultrasonic stack assembly while delivering ultrasonic energy to the components.

**Quality Widows & Limits:** Programmable values used by the system to compare actual process data. Actual process data must be within limits or an alarm condition will exist.

**Setup Mode:** The condition the control box must be in prior to adjusting parameters, quality windows, and/or any others settings except those contained within the Command Mode.

**Squeeze Time:** The amount of time after the ultrasonic tooling engages the component(s) and before delivery of ultrasonic energy. -- Adjustable from 0 - 0.5 seconds

**Stress:** Stress is the amount of dynamic force per cross sectional area.

**Time:** Time is the duration of the ultrasonic, mechanical, activity. Time is a component used to calculate the amount of ultrasonic energy delivered during a weld cycle, (Time = Joules / Watts).

**Tip:** Device specially designed to grip the upper component, to be welded, and to direct the ultrasonic energy into the work piece, (Also: Horn Tip & Replaceable Horn Tip).

**Tip Nut:** Device specially designed to securely clamp a replaceable tip onto the horn.

**Trigger Force:** (See: Force).

**Tuning:** Adjusting to optimize power supply performance according to resonance frequency, especially with regard to the horn and converter.

**Velocity:** The rate of motion at a specific time [velocity = distance / time] (also referred to as speed).

**Weld Mode:**

- **Weld In Energy:** System delivers ultrasonic energy until a predetermined amount of energy, in joules is dissipated. The system determines energy by calculating the area beneath the power curve --  $\text{Watts} \times \text{Time} = \text{Joules}$  (1 watt per second = 1 joule).
- **Weld In Height:** System delivers ultrasonic energy until the ultrasonic tooling reaches a predetermined position.
- **Weld In Time:** System delivers ultrasonic energy for a predetermined amount of time.
- **Welding Parameters:** (See: Parameters).



---

## **Chapter 3: Shipping and Handling**

---

**3.1 Unpacking, Handling & Installation . . . . . 22**

## 3.1 Unpacking, Handling & Installation

Unpack the Actuator and Touchscreen Controller. Remove the top cover of the power supply and check if any components became loose during shipment.

### 3.1.1 If damage has occurred

Notify the shipping company immediately. Retain packaging materials for inspection and possible re-use.

### 3.1.2 System Location

Locate the Touchscreen Controller in an area away from radiators or heating vents. Allow sufficient clearance in back of the controller to access the connectors. Observe the following:

- Do not block the exhaust or air intake areas. Proper air circulation is necessary to maintain a safe operating temperature
- Only operate the controller within an ambient temperature range of 41°F to 122°F (5°C to 50°C)
- Verify that neither dust nor dirt are allowed to restrict the flow of air exhaust or air intake. Clean the air ports as necessary

If the temperature of the power supply exceeds the recommended operating range, a thermal switch will stop ultrasonics and the power supply will display an Overload alarm. Ultrasonics will remain off until the power supply cools to a safe operating temperature and the RESET button is pressed.

If the environment is excessively dirty or oily, contact Branson for assistance. Special Touchscreen Controller enclosures, filters (i.e. filter/separator/regulator), and other equipment are available.

### 3.1.3 System Assembly

Connect the actuator system per the Hookup diagram contained in the Special Information Instruction Set. Verify that connections are complete and correct before proceeding. Plug the Controller into a proper power source. See the Touchscreen Controller Instruction Set for power specifications, plugs and receptacles used.

To prevent the possibility of an electrical shock, always plug the power supply into a grounded power source. Be sure the power switch is in the Off position before making any electrical connections.

Connect the system to a clean (5 micron air filter with 0.5 micron mist separator), dry, 80 psig (5.5 bar) minimum air supply. See the Actuator Instruction Set for information on the set up of application tooling and the use of this equipment for ultrasonic welding.

### 3.1.4 Crash Gap Adjustment

In most applications, adjustment of the gap between the ultrasonic Horn Tip and the Anvil is factory set to prevent these surfaces from contacting each other when no parts to be welded are present and the foot pedal is depressed. A poorly adjusted crash gap can cause serious damage to the tooling. See the Actuator Instruction Set for proper setup instructions.

### 3.1.5 Operating the System

With all proper connections made and with tooling properly set up, welding may be performed. In most instances it is likely that Branson has developed weld settings for your application and stored them as presets in the controller prior to shipping. See the Touchscreen Controller Instruction Set for information on retrieving presets. For other

weld parameter information pertaining to your system, see the parameter preset page included in the Special Information Instruction Set.



---

## **Chapter 4: Troubleshooting**

---

<b>4.1</b>	<b>Troubleshooting</b> .....	<b>26</b>
<b>4.2</b>	<b>Weld Overload</b> .....	<b>27</b>
<b>4.3</b>	<b>Low Air Pressure</b> .....	<b>28</b>
<b>4.4</b>	<b>Ready Check</b> .....	<b>29</b>
<b>4.5</b>	<b>Troubleshooting Guide</b> .....	<b>30</b>

## 4.1 Troubleshooting

This section shows how to fix some of the possible errors and problems which may occur in normal use of the MWX100/ Ultrasplice system.

## 4.2 Weld Overload

Weld overloads are premature shut downs of the power supply. Overloads signify excessive loads and must be corrected if continued reliability of the equipment is to be maintained. Hardware internal to the supply are controlling this function and it can not be defeated.

The control system analyzes the end of weld characteristics to check for overloads. If the system determines an overload an alarm occurs. The control halts action until the system is reset.

Some of the possible causes for overloads are:

- The tool clearances are too small, horn and anvil touch during welding
- Excessive air pressure with low amplitude
- Defective Stack assembly
- Defective Power Transistors in power supply

## 4.3 Low Air Pressure

The control system and its components were designed to run with a clean air supply of from 90 to 120 psi. The control system monitors the air pressure from the low air pressure switch (optional). The low pressure threshold is set from the controller. An alarm occurs when incoming line pressure the drops below the set pressure.

## **4.4 Ready Check**

The system undergoes a Ready Check operation at every startup, the end of every weld, and at the exit of Setup mode. This procedure checks the height encoder position. If an incorrect height value is returned, an alarm occurs.

Some of the possible causes of a Ready Check alarm are:

- The horn is stuck in the closed position
- Maintenance has moved the height encoder to an out of limit condition
- Defective encoder or electronics
- Encoder not plugged in to its connector

## 4.5 Troubleshooting Guide

**Table 4.1** Troubleshooting Guide

Problem	Solution
System will not turn on.	Power cable plugged in. Power turned on at the outlet. Check internal fuses on the Controller Line Board.
Plant fuse fails or circuit breaker trips when plugging the unit into an electrical outlet.	Inspect power cord, replace if shorted. Check line filter, replace if failed.
Plant fuse fails or circuit breaker trips during weld cycle.	Check current rating of the plant fuse or the circuit breaker, replace if failed.
Line fuse fails.	Check fuse current rating, replace if incompatible. Check fan motor, replace if failed.
Horn will not move down or up.	System not connected to air supply. Air not turned on.
Get Emergency Stop when system is turned on.	Check Emergency Stop Switch. All cables properly connected. Press red switch on foot pedal. (if system is equipped with one)
No Sonics when test button is pressed.	RF Cable connected. Check RF cable for broken wire. Ribbon cable in power supply between SPM and programmer unplugged.
No sonics during weld cycle.	Check all cable connections. Check start cable for broken wires. Check inside power supply for loose start cable from rear of unit to programmer board. Check thermo switch in power supply.

**Table 4.1** Troubleshooting Guide

Problem	Solution
Overloads when welding.	Stack not tuned properly. Tooling not set up properly. Crash gap not set properly. Tip nut cracked, replace if needed. Check weld parameters. Check stack interfaces for fretting. Check for loose or failed horn or booster, tighten or replace as necessary.
When touching the system you get a slight electrical shock.	Inspect power cord, replace if needed. Inspect system ground, repair if needed.
Tooling heats up after machine runs a while.	Cooling air is not turned on or is not on long enough. Cooling air is not directed at tooling.
Low weld strength.	Check weld parameters. Check tooling gaps. Check knurl on tooling. If worn replace tooling. Increase Energy. Check the Down stop adjustment. Check for part contamination. Ensure all hardware is tight.
Excessive welding.	Reset parameters. Reset amplitude. Reset pressure. Measure and re-calibrate amplitude display.
Time limit error or peak power error displayed after weld cycle.	Reset limits. Check tip, rotate or replace if worn. Check anvil for wear, rotate or replace if worn. Check air pressure setting. Check up stop for proper adjustment. Process settings have to be opened up due to part variance or limits should be adjusted according to the part/wire being run. Check anvil clamp for proper torque.

**Table 4.1** Troubleshooting Guide

Problem	Solution
Squealing sound during welding or when test key is depressed.	Check plate screws and tighten or replace. Check cover plate screws and tighten. Reset gaps. Re-square horn/tip and reset gaps. Reset horn tip and gap.
Weld heights are inconsistent.	Re-calibrate encoders with 1mm gauge. Ensure the connector for the encoder is tightly plugged into the actuator card.
Horn is stuck in down position.	Check air pressure. Ensure air lines are installed properly. Check for kinks in air lines.
Air leaking from machine.	Ensure all air line connections are tight. Check for cracked or broken air lines.
Unusual sound during weld cycle.	Check tooling gap. Check converter. Check stack assembly.
Squealing sound from power supply when unit is turned on.	Check cooling fans in rear of unit.
Maintenance counter alarm.	Reset maintenance counter.
Actuator arm moves sluggish.	Check air lines for contamination. <b>NOTE:</b> Air must be filtered to 5 microns and be oil and water free. Check solenoid valve, replace if needed. Check air regulator.
System has READY CHECK message.	The horn is stuck in the closed position. Maintenance has moved the height encoder to an out of limit condition. Defective encoder or electronics. Encoder not plugged into the actuator card.
Time, height and energy inconsistent.	Switch to energy mode & open height window. Make some sample welds. Check the time and the height of the welds for consistency. If the time or weld thickness varies greatly, check the air regulator.

---

# **Chapter 5: Maintenance**

---

**5.1 Periodic Maintenance . . . . . 34**

## 5.1 Periodic Maintenance

In order to maintain optimum operating conditions, it is important to perform various maintenance and equipment inspections at periodic intervals. Please observe the following recommendations.

### Daily

- Drain water and contaminants from the airline filters, if required

### Every Tool Rotation

- Inspect the clamping surfaces of the Tip, the Tip Nut and the Horn for fretting
- Vacuum and clean out any copper residue or dirt in the actuator

### After 40k-50k Cycles Maximum (subject to change based on weld application):

- Vacuum and clean inside of power supply
- Calibrate pressure regulator
- Clean and torque the stack interface
- Calibrate amplitude

### 5.1.1 FSR Assembly

Air Filter/Separator/Regulator (Optional Branson Part #207-020) should be serviced after 1 year or when a pressure drop of 15 psi is reached.

- Disconnect the air supply
- Remove and clean out filter bowl with a clean rag
- Replace the white filter element and re-assemble
- Remove and clean out separator bowl with a clean rag
- Replace brass-colored filter element and reassemble
- Reconnect air supply

**Do not use solvent to clean filter bowls.**

CAUTION	
	Clean the air filter bowl with a mild household soap only. The bowl is made from a polycarbonate material, which can rupture if exposed to synthetic lubricating oils solvents or harsh chemicals. The bowl is rated for a maximum line pressure of 140 psig (1043 kPa) and a maximum temperature of 120°F (49°C).



**EMERSON**<sup>™</sup>

Original Instructions  
DCM00056 - REV. 03



# MWX100 Actuator

# Instruction Manual

**Branson Ultrasonics Corp.**  
120 Park Ridge Road  
Brookfield, CT 06804  
(203) 796-0400  
<http://www.bransonultrasonics.com>

**BRANSON**



---

# Table of Contents

---

**Chapter 1: MWX100 Actuator**

1.1	Mechanical Actuator System . . . . .	2
1.2	Ultrasonic Stack Assembly . . . . .	3
1.3	Controls and Adjustments . . . . .	6
1.4	Tool Gap Requirements. . . . .	9
1.5	Ultrasonic Stack Disassembly . . . . .	12
1.6	Height Calibration . . . . .	16
1.7	Slide Maintenance . . . . .	18
1.8	Lubrication Schedule . . . . .	19
1.9	Recommended Spare Component Lists . . . . .	20
1.10	Ultraweld 40 Tool Kit . . . . .	21
1.11	File Attachments . . . . .	22



---

## List of Figures

---

### Chapter 1: MWX100 Actuator

Figure 1.1	MWX100 Actuator . . . . .	2
Figure 1.2	Ultrasonic Stack Assembly . . . . .	3
Figure 1.3	Solid Horn, and Replaceable Tip Horn . . . . .	4
Figure 1.4	Actuator Slide Mechanism . . . . .	5
Figure 1.5	Speed Controls and Cooling Knob Location . . . . .	6
Figure 1.6	Up/Down Stop Locations . . . . .	8
Figure 1.7	Tool Gap . . . . .	9
Figure 1.8	Knurl Pattern Imprint Evaluations . . . . .	10
Figure 1.9	Cleaning object mating surface direction . . . . .	13
Figure 1.10	Exploded Ultrasonic Stack Assembly . . . . .	14
Figure 1.11	Tool Cleaning . . . . .	15
Figure 1.12	Height Calibration . . . . .	16



---

## List of Tables

---

**Chapter 1: MWX100 Actuator**

Table 1.1	Equipment Specifications . . . . .	2
Table 1.2	Ultrasonic Stack Assembly Parts . . . . .	14
Table 1.3	Primary Spare Items . . . . .	20
Table 1.4	Secondary Spare Items (Optional Items) . . . . .	20
Table 1.5	Tool Kit (R3A00A68) . . . . .	21
Table 1.6	File Attachments . . . . .	22



---

# Chapter 1: MWX100 Actuator

---

<b>1.1</b>	<b>Mechanical Actuator System</b>	<b>2</b>
<b>1.2</b>	<b>Ultrasonic Stack Assembly</b>	<b>3</b>
<b>1.3</b>	<b>Controls and Adjustments</b>	<b>6</b>
<b>1.4</b>	<b>Tool Gap Requirements</b>	<b>9</b>
<b>1.5</b>	<b>Ultrasonic Stack Disassembly</b>	<b>12</b>
<b>1.6</b>	<b>Height Calibration</b>	<b>16</b>
<b>1.7</b>	<b>Slide Maintenance</b>	<b>18</b>
<b>1.8</b>	<b>Lubrication Schedule</b>	<b>19</b>
<b>1.9</b>	<b>Recommended Spare Component Lists</b>	<b>20</b>
<b>1.10</b>	<b>Ultraweld 40 Tool Kit</b>	<b>21</b>

## 1.1 Mechanical Actuator System

The MWX100 system is comprised of a power supply and control box, ultrasonic stack assembly, application tooling, and mechanical actuator. The mechanical actuator is the system that rigidly holds and moves the converter, booster, and horn assembly known as the ultrasonic stack. A pneumatic cylinder drives the actuator to apply a precise pressure to the parts to be welded during the weld cycle.

**Figure 1.1** MWX100 Actuator

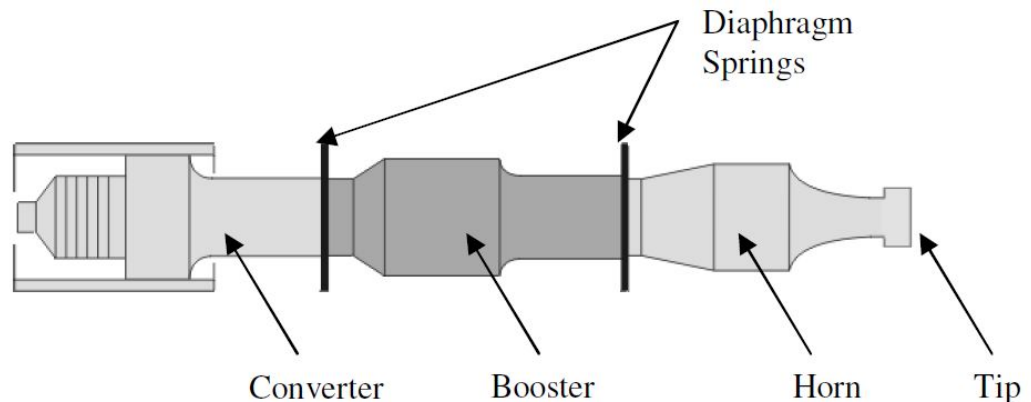

**Table 1.1** Equipment Specifications

Specifications	
Length	18.4in (467mm)
Height	14.7in (373mm)
Width	8.5in (216mm)
Stroke	0.98in (25mm)
Weight	49 lbs (22kg)

## 1.2 Ultrasonic Stack Assembly

**Figure 1.2** Ultrasonic Stack Assembly



### 1.2.1 Converter

The 40 kHz electrical energy from the power supply is applied to the transducer element or converter, which transforms the high frequency electric current into high frequency mechanical vibrations at the same frequency. The heart of the converter is a leadzirconate-titanate electrostrictive element that, when subjected to an alternating voltage expands and contracts. The converter's efficiency of changing electrical energy to mechanical vibrations exceeds ninety-five percent.

### 1.2.2 Booster

A booster couples the converter to the horn and helps determine the amplitude of vibration produced at the face of the horn. The booster is a resonant half-wave metal device made of titanium or aluminum and is designed to resonate at the same frequency as the converter with which it is to be used.

A booster has two functions:

1. A rigid mounting for the converter/booster/horn stack
2. An amplitude-of-vibration increaser or decreaser as ultrasonic energy is transmitted from the converter through the booster to the horn. The ratio of input to output amplitude is called the gain.

### 1.2.3 Horn

The horn is a half-wave length resonant metal device that transfers the ultrasonic vibrations from the booster to the weld tip. The horn is made of steel (titanium for replaceable tip tooling) and is designed to resonate at 40 kHz. The acoustical efficiency of the steel and titanium helps to maintain constant amplitude throughout the operating temperature of the welder. Since the horn is a vital part of the ultrasonic assembly system, it should not be altered without proper training and advice from Branson Metal Welding. Depending upon the particular application at hand, the horn may be either a solid horn as shown in [Figure 1.3 2a](#), or a Horn with a replaceable tip that can be rotated or replaced as shown in [Figure 1.3 2b](#).

**Figure 1.3** Solid Horn, and Replaceable Tip Horn

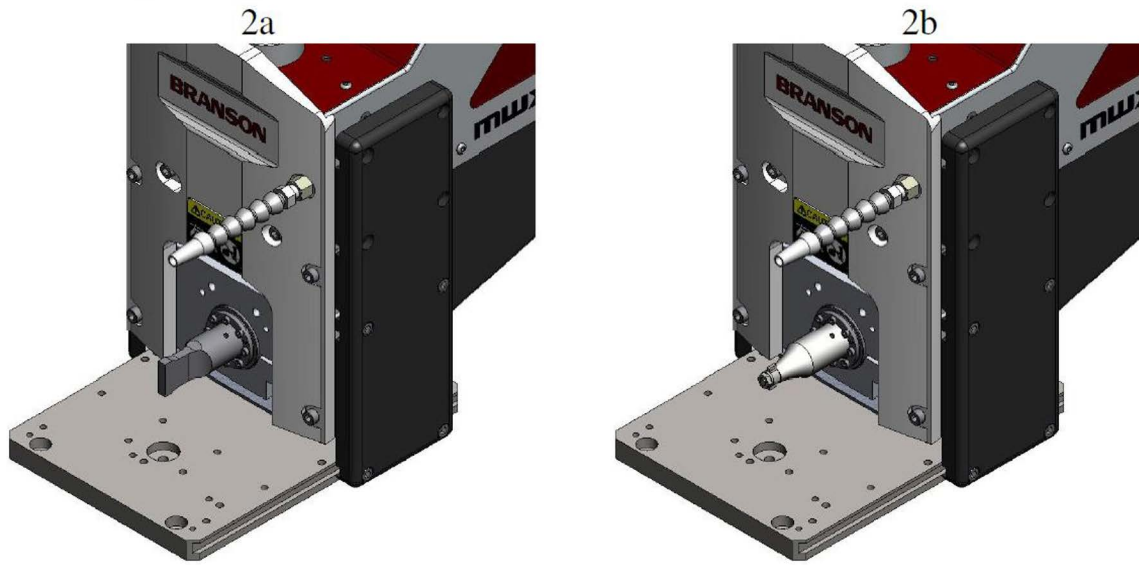

## 1.2.4 Welding Tip (Replaceable Tip Tooling)

The welding tip is designed to grip the upper component of the part to be welded, and to couple the ultrasonic vibrations through that element into the bonding area. Welding tips are fabricated from high-speed tool steel and heat-treated to precise specifications to provide maximum life. The tip is coated to further enhance tool life and to provide corrosion resistance. The patented tip design offers multiple weld surfaces by indexing the tip on the horn to a new weld area.

## 1.2.5 Tip Nut (Replaceable Tip Tooling)

The tip nut is made of titanium and is designed to securely clamp the tip onto the horn. The horn-welding tip-tip nut assembly is an efficient system for transmitting ultrasonic vibration to the parts to be welded and offers an interchangeable tool at a low cost.

## 1.2.6 Polar Shell & Ultrasonic Stack

The converter-booster-horn assembly, or ultrasonic stack, is supported in a steel Polar Shell by means of two diaphragm springs. The diaphragm springs are mounted at either end of the booster and are securely bolted to the Polar Shell. The diaphragm shaped springs are made from titanium and are acoustically tuned at the 40 kHz operating frequency. This system permits efficient transmission of ultrasonic vibration along the axis of the ultrasonic stack while providing rigid mounting.

## 1.2.7 Anvil

The anvil is made of high-grade tool steel and coated for maximum wear and corrosion resistance. The patented tool design allows it to be rotated to present multiple weld surfaces.

## 1.2.8 Actuator

The ultrasonic stack is mounted into a steel polar block and securely clamped in place. The polar block is mounted to a crossed roller recirculating bearing which provides precise vertical travel of the stack assembly, while providing excellent rigidity to resist any loss of ultrasonic energy in the horizontal direction of sonic vibrations. See [Figure 1.4](#).

## 1.2.9 Application Tooling

Application tooling is designed and manufactured to position and weld component materials to meet customer specifications. Application tooling typically consists of a horn / tip / tip nut, anvil, anvil clamp, anvil holder, and tool support. See [Figure 1.4](#).

**Figure 1.4** Actuator Slide Mechanism

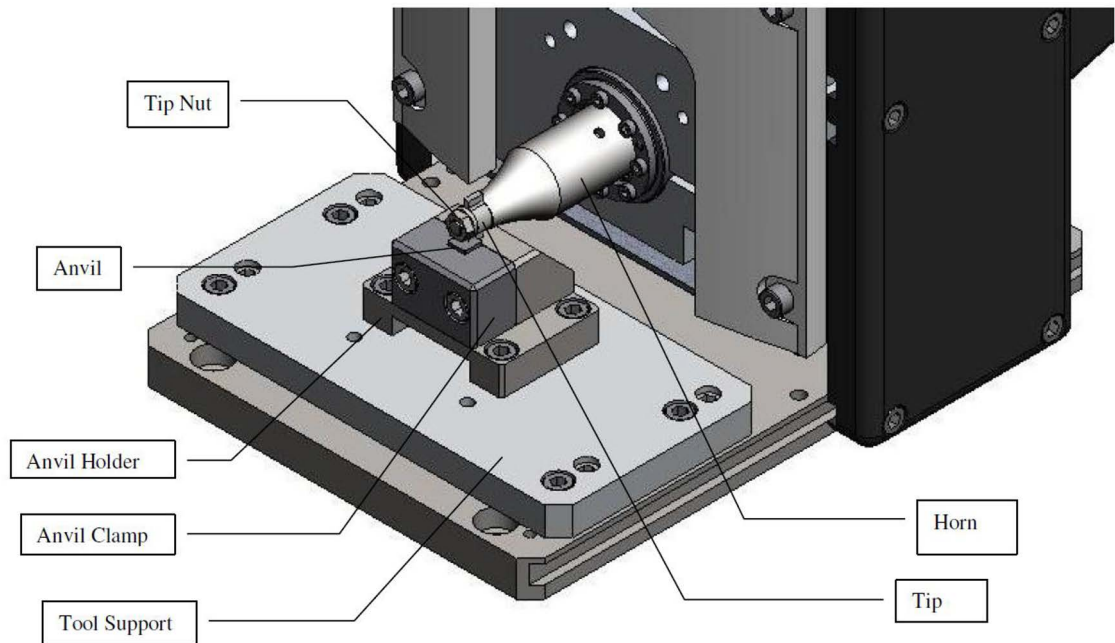

## 1.3 Controls and Adjustments

### 1.3.1 Speed Up

The Speed Up knob, located on the rear of the actuator, controls the upward speed of the ultrasonic stack. This is useful for raising the stack quickly for other mechanism actions and for quick part removal.

To DECREASE the upward speed, turn the indicated knob clockwise.

To INCREASE the upward speed, turn the indicated knob counter-clockwise.

### 1.3.2 Speed Down

The Speed Down knob, located on the side of the actuator, controls the downward speed of the ultrasonic stack. This is useful to prevent damaging the parts to be welded, increasing/decreasing cycle times to get better weld results.

To DECREASE the downward speed, turn the indicated knob clockwise.

To INCREASE the downward speed, turn the indicated knob counter-clockwise.

### 1.3.3 Cooling Air

NOTICE	
	<p>Do not turn cooling air off completely using the cooling air adjustment knob. Doing so may damage the converter.</p>

Cooling air is designed to keep the weld area and the converter cooled to a reasonable temperature during welding.

To INCREASE cooling airflow rate, turn the cooling air control knob counter-clockwise.

To DECREASE cooling airflow rate, turn the cooling air control knob clockwise.

**Figure 1.5** Speed Controls and Cooling Knob Location

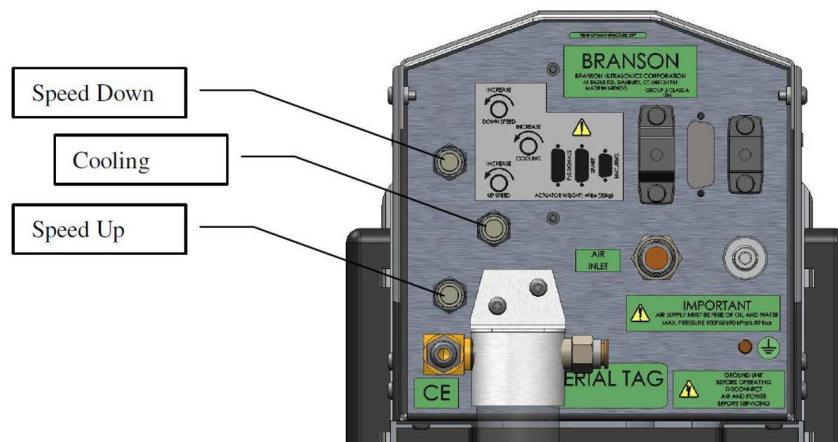

### 1.3.4 Adjustment of the Down Stop

NOTICE	
	See <a href="#">Figure 1.6</a> for location.

The down stop is used as a safety to prevent contact between the Horn and Anvil if the welder is cycled without the part(s) to be welded. Unless otherwise specified, a 0.004" (0.10 mm) gap between the Horn and Anvil is recommended.

**To adjust the down stop:**

1. Loosen the M10 Hex Nut on top of the weld cylinder.
2. Turn the Down Stop Knob counter-clockwise to increase the maximum downward travel end position.
3. Turn the Down Stop Knob clockwise to decrease the maximum downward travel end position.
4. Tighten the M10 Hex Nut when the desired down travel location is achieved.

### 1.3.5 Adjustment of the Up Stop

NOTICE	
	See <a href="#">Figure 1.6</a> for location.

The up stop is used to limit the upward travel of the Horn. Two examples for the use of the up stop are limiting the upward travel to quicken cycle times and for easier loading and unloading of components.

**To adjust the up stop:**

1. Loosen the M6 set screw (accessed through the front plate) so that the up stop screw moves smoothly.
2. Using a long wrench or T-handle, turn the M10 Set Screw counter-clockwise to increase the maximum upward travel end position.
3. Using a long wrench or T-handle, turn the M10 Set Screw clockwise to decrease the maximum upward travel end position.
4. Tighten the M6 set screw when the desired upward travel location is achieved.

**Figure 1.6** Up/Down Stop Locations

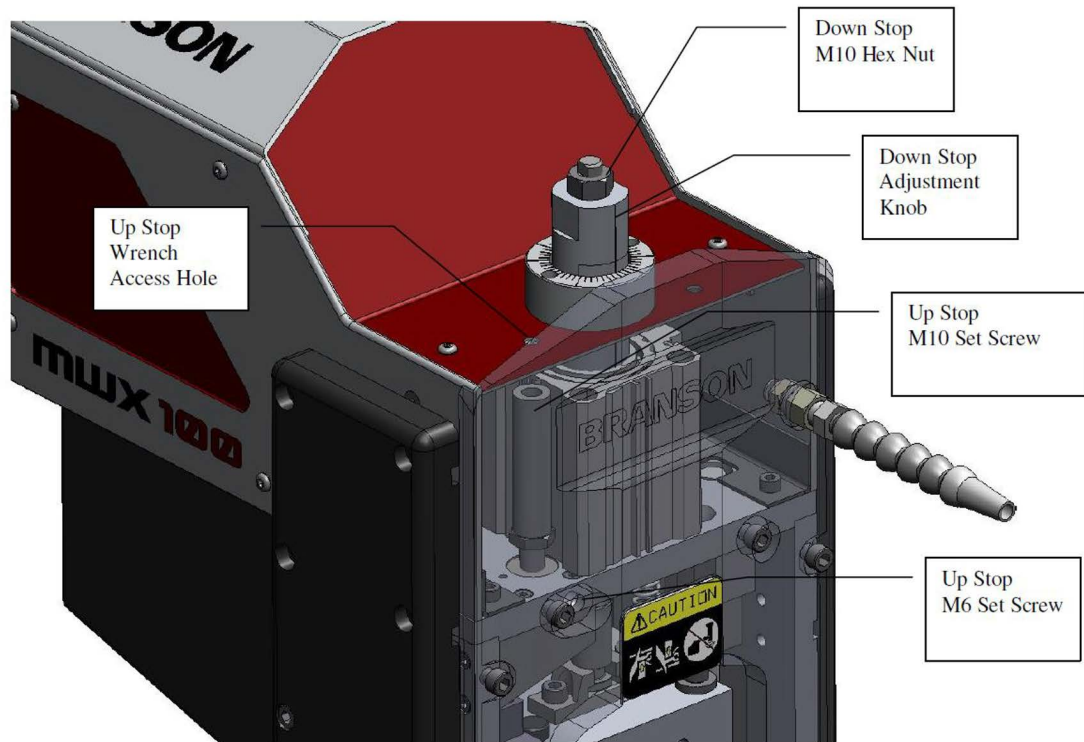

## 1.4 Tool Gap Requirements

Tooling includes the Horn (or Horn Tip), Anvil and all surfaces that contact the weld nugget during processing. The tooling should be inspected to confirm a gap as per the application tooling set up sheet. If the tooling is in contact during the application of ultrasonic energy, severe damage may result to the tooling and power supply.

NOTICE	
	<p>This test should be checked whenever the tooling is changed. Also perform this test whenever you suspect tool contact.</p>

Most tooling that contacts the weld nugget is designed with several weld surfaces. When one surface is worn and no longer useful, an alternate surface may be used resulting in extended tool life.

To set the Tool Gap set the air regulator at the same pressure as the weld pressure. Ensure that there are no work pieces between the Horn and Anvil. Press the SETUP button on the power supply, then press the HORN button, which will cause the Horn to descend to its stop. Measure this crash gap as per the application tooling setup sheet.

Press the HORN button again to raise the Horn and adjust the down stop screw located on the top of the actuator.

**Figure 1.7** Tool Gap

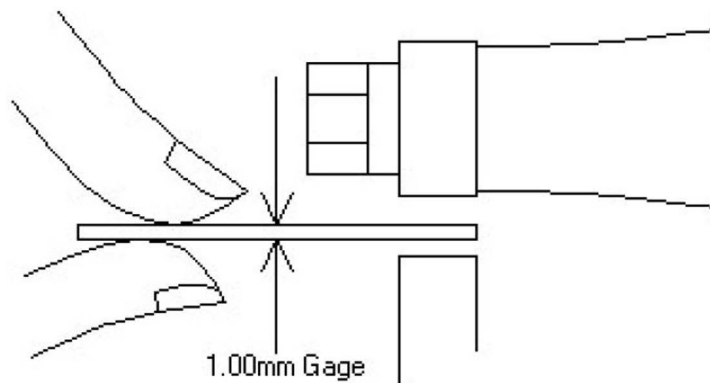

The Branson Metal Welding MWX100 is capable of accurate height measurements and can adjust for weld pressure and crash gap settings. All tool setups especially crash gap must be complete before this procedure.

### 1.4.1 Knurl Pattern Imprint Evaluation

The imprint that the tooling creates on the interface is a result in the aligning the welding tip to the anvil. If the weld appears heavy to a certain side, readjustment of the tooling will be required to get even weld results across the weld surface. Typically, using carbon paper will give the best results. [Figure 1.8](#) shows what typical imprints will look like and the corrective action to be taken.

**Figure 1.8** Knurl Pattern Imprint Evaluations

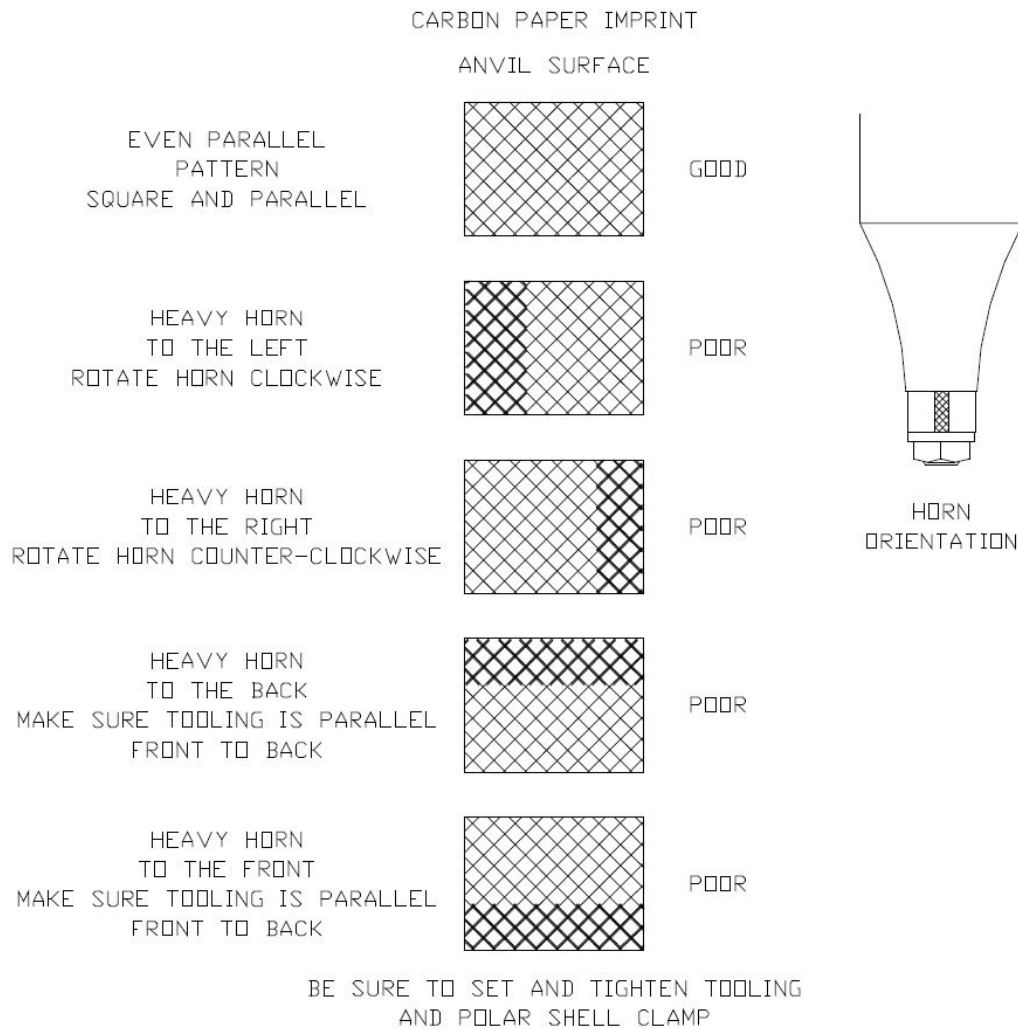

## 1.4.2 Torque Check

Proper tightness of tooling is critical to assure efficient transmission of ultrasonic energy into the weld nugget. Please check the tightness of the following areas during a tool change or whenever looseness is suspected.

Horn to Booster 150 IN-LBS (16.9 N-M)

Converter to Booster 150 IN-LBS (16.9 N-M)

Tip Nut (if used) 100 IN-LBS (11.3 N-M) (Unless otherwise specified)

## 1.4.3 Check Welder Performance

Ensure that nothing is touching the tip on all four sides. With the tooling disengaged and unloaded, press the "TEST" button on the power supply for no longer than one second. If there is a loud squealing noise, the problem may be in the following areas:

1. The Tip may not be secured properly.
2. The Horn may not be secured properly.
3. Tooling may be in contact with each other.

#### 1.4.4 Establishing Weld Parameters

With the tooling properly set up and with the ultrasonic stack tuned, welding may be performed. Optimize the weld settings in the following manner:

NOTICE	
	Weld parameters may already be established. Refer to Parameter Preset Information located in the Special Information Section.

1. Set weld energy and pressure for initial weld trials to minimum values: 50 joules and 15 PSIG for air pressure as a starting point.
2. Place the parts to be welded securely into the fixture.
3. Cycle the welder by actuating the foot switch or the start switches.
4. Inspect the welded joint.
5. Increase/decrease the values for energy and air pressure as necessary to reach an acceptable level of welding.

## 1.5 Ultrasonic Stack Disassembly

NOTICE	
	See <a href="#">Figure 1.10</a> for item listings.

The transmission of ultrasonic energy along the stack requires a tight and clean interface between the Converter, Booster, Diaphragm Springs and Horn.

Please remove the stack and check the interfaces after 40k - 50k cycles or whenever a problem is suspected. The procedure is as follows:

1. Be sure that the power supply is off to prevent any possible electrical shock from the high voltage contact on the converter.
2. Disconnect the cable at the rear of the Converter (Item 8).
3. Remove the Tip Nut and Tip (applicable to replaceable tip horns only). Check the Tip and Nut to be sure that the clamp surfaces are clean and smooth. Follow the instructions in [Figure 1.11](#).

NOTICE	
	Clean only the clamp surface, not the knurl area.

4. Using the torque wrench and the Torque Wrench Adapter, remove the Horn (Item 6) from the Stack Assembly.
5. Remove the eight M3 SHCS's (Item 9), the Clamp Ring (Item 1) and the Front Diaphragm Spring (Item 2).
6. Remove the eight M3 SHCS's (Item 9) from the back end of the Polar Shell (Item 4).
7. The Converter (Item 8), Clamp Ring (Item 1), Rear Diaphragm Spring (Item 3) and Booster (Item 7) can now be slipped out of the Polar Shell (Item 4) towards the rear of the actuator.
8. With two spanner wrenches carefully separate the Booster from the Converter. Check and clean the mating surfaces of these components with an oilstone or 600-grit paper as shown below.
  - a. Place 600 grit emery on a hard, flat surface. Place component on emery with the mating side you wish to clean face down.
  - b. Do not press down. Using only the weight of the converter, booster, or horn as downward pressure, drag the component across the emery in a single, straight, long stroke (see [Figure 1.9](#)).

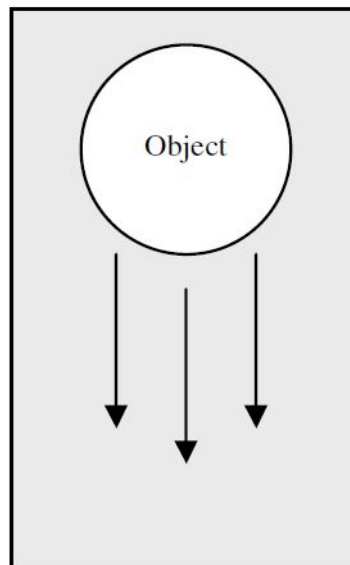
**Figure 1.9** Cleaning object mating surface direction

- c. Turn the component 90 degrees and repeat step 2. Repeat this procedure until all mating surfaces are clean.
9. Clean and then polish away any roughness on the Diaphragm Spring.
10. Assemble the stack per the steps in the next section.

### 1.5.1 Ultrasonic Stack Assembly

NOTICE	
	See <a href="#">Figure 1.10</a> for item listings.

1. Clean Horn, Converter, Booster and diaphragm surfaces with solvent to remove all contaminants and previously used paste.
2. Apply an even, light coat of Molykote G-n paste (about equal in size to half a paper match head) to the mating surfaces of the Converter, Booster and Horn. Do NOT apply paste to threaded opening or to stud threads or to diaphragm. Do NOT use silicone grease.
3. Place the Rear Diaphragm Spring (Item 3 – 0.316" f center hole) and Clamp Ring (Item 1) onto the studded end of the Booster (Item 7). Then thread the Booster into the Converter. Be careful to center the Diaphragm Spring on the Booster and then torque Booster and Converter to 150 IN.-LBS (16.9 N-m) using two spanner wrenches. Do not clamp on the Converter.
4. Slide the Booster/Converter subassembly in through the rear of the Polar Shell. Assemble the eight M3 SHCS's to fasten in an alternating pattern the Clamp Ring to the rear of the Polar Shell.
5. Place a Clamp Ring and the Front Diaphragm Spring (Item 2 – 0.500" f center hole) onto the studded end of the Horn (Item 6). Then thread the Horn into the Booster. Assemble the eight M3 SHCS's to fasten in an alternating pattern the Clamp Ring to the front of the Polar Shell. Be careful to center the Diaphragm Spring on the Horn and then torque Booster and Horn to 150 IN.-LBS (16.9 N-m).

- Replace the Tip and loosely thread on the Tip Nut. (applicable to replaceable Tip Horns only) The Tip (or Horn blade) will have to be made square and parallel to the Anvil prior to welding.

<b>NOTICE</b>	
	<p>Do not operate ultrasonics while the tip is loose.</p> <p>Do not operate ultrasonics without connecting the converter lead wire and ground.</p>

**Figure 1.10** Exploded Ultrasonic Stack Assembly

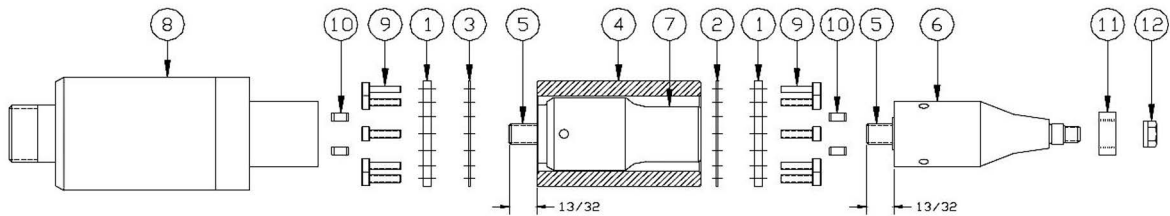

**Table 1.2** Ultrasonic Stack Assembly Parts

Item	Description	Item	Description
1	Clamp Ring	2	Diaphragm Spring, front
3	Diaphragm Spring, rear	4	Polar Shell
5	M8 Stud	6	Horn
7	Booster	8	Converter - 4TR
9	Socket Head Cap Screw	10	Dowel Pin
11	Tip	12	Tip Nut

After prolonged use, burrs may form on the clamping surfaces of the tooling. These burrs may be removed from the tip and tip nut by polishing with 600 grit emery paper placed on a flat surface. With light pressure, polish the clamp faces in a figure 8 pattern.

The burrs on the horn clamping surface must be removed by machining back the horn clamp surface. The least amount of material should be removed, but in no case should more than .020" be removed. The undercut at this clamping surface must also be recut.

**Figure 1.11** Tool Cleaning

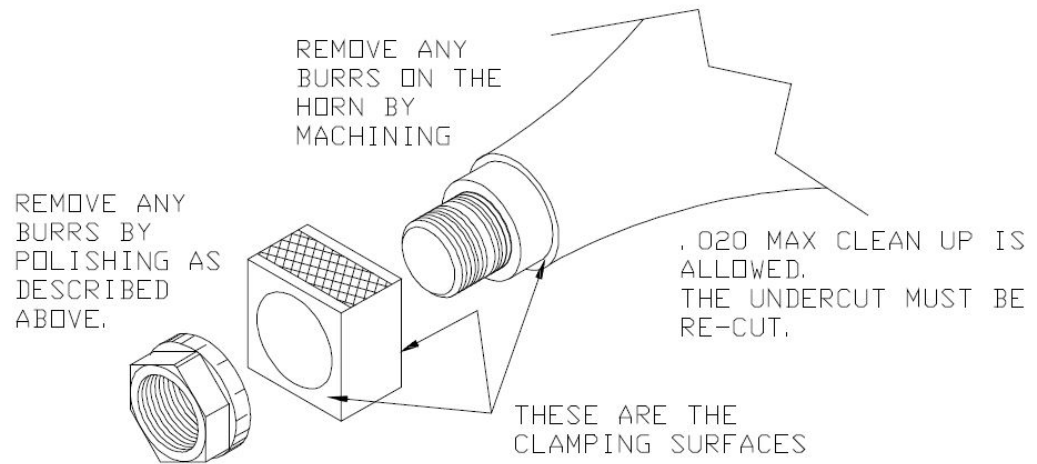

## 1.6 Height Calibration

Figure 1.12 Height Calibration

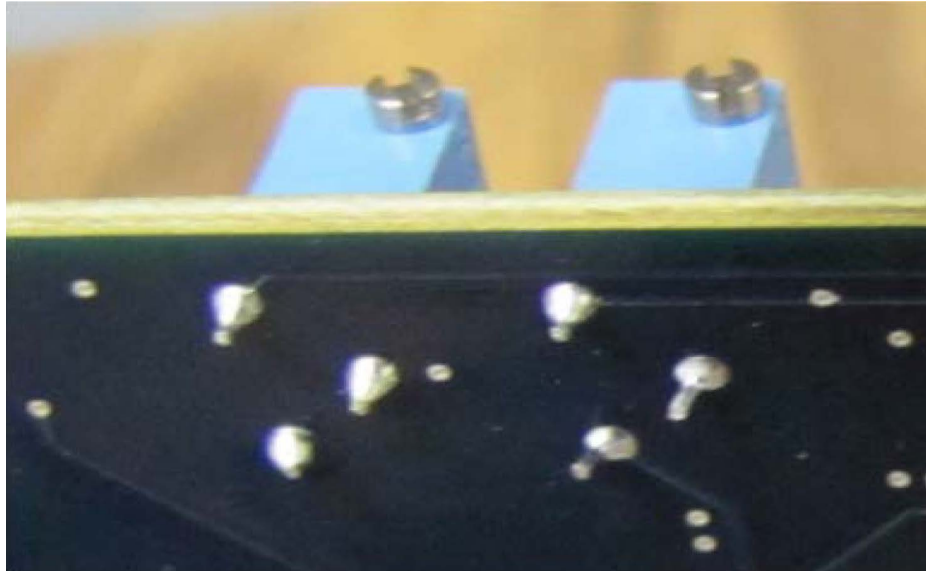

Go to the Height Calibration screen:

### Adjust the Pots

1. Bring the horn down by pushing "Horn" button.  
The voltage on the display should be around 2-5mV.  
If it is not, adjust the 'Zero pot' until you get the right voltage

NOTICE	
	<ol style="list-style-type: none"><li>a) On 632 board, the Zero pot is R-22.</li><li>b) On 981 board, the Zero Pot is R-57</li></ol>

2. Bring the Horn up by pressing the "Horn" button.  
Turn the Span pot to achieve the maximum voltage.  
Then turn the voltage down until you see the voltage on the screen fluctuating [you can come down by 2-3mV from the maximum attained voltage]

NOTICE	
	<ol style="list-style-type: none"><li>a) On 632 board, the Span pot is R-40</li><li>b) On 981 board, the Span Pot is R-59</li><li>c) Stop turning the pot immediately, as soon as you reach the maximum voltage.</li></ol>

## **1.6.1 Calibration**

1. Put 1mm shim and press "Calibrate" button. The horn comes down 8 times on the 1mm shim. You should get "Calibration Step 1 done" message.
2. Put 6mm shim and press "Calibrate" button. The horn comes down 8 times on the 6mm shim. And "Calibration has done" message should be displayed.

If the message is displayed as "Unsuccessful Calibration", repeat all the above steps again.

## **1.6.2 Adjust**

1. Disconnect the ultrasonics RF cable on the actuator.
2. Get into the setup screen and weld on 1mm shim in time mode [time=0.2sec].
3. Adjust the first reading in the adjust screen.

## 1.7 Slide Maintenance

### 1.7.1 Lubrication

The purpose of lubrication for the linear motion rolling guides is to prevent direct metal-to-metal contact of the raceways and rolling elements, thereby reducing friction, wear, and heat generation. When an adequate grease film is formed between the raceways and rolling elements at the rolling contact area, the contact stresses due to weld loading can be moderated.

A quality lithium-soap base grease containing extreme pressure additives (Alvania EP Grease 2 (SHELL)) is pre-packed in the recirculation crossed roller slide. However, the quality of any grease will gradually deteriorate over time. Periodic re-lubrication is essential. The re-lubrication interval varies depending on the operating conditions of the rolling guides. A six-month interval is generally recommended. If the machine operates at a high cycle rate (i.e. 42 cycles/min = 100,000 cycles a week, 40 hrs/wk) and/or short strokes, re-lubrication every three months is recommended. A grease nipple is provided at the slide unit for re-lubrication.

#### **Access to the grease fitting is achieved in two ways depending on revision of actuator:**

1. Remove the black cover plate on the side of the actuator. Once removed, there is an access point in the steel housing to insert the grease nozzle onto the fitting.
2. Remove the front plate of the actuator. Once removed the grease fitting is located in the upper left corner of the actuator. Insert the grease nozzle to apply the grease.

New grease must be supplied through the grease fitting until the old grease is discharged. After the grease is replenished, cycling the actuator will cause the excess grease to be discharged from the inside of the rolling guide. Discharged grease must then be removed before starting regular operation. Generally, immediately after grease is replenished, frictional resistance tends to increase. If cycling the actuator is performed for 10 to 20 cycles after excess grease is discharged, frictional resistance becomes small and stable.

## 1.8 Lubrication Schedule

Actual lubrication interval is under the influence of each application and environment.

NOTICE	
	<p>When re-mounting the slide block to the rail for any reason, care must be taken to avoid dislodging rollers from the tracks within the slide block.</p>

Branson Metal Welding recommends the following schedule as an initial plan to follow:

1. After 1 month of normal operation:
  - a. Inspect interior of actuator for possible grease discharge.
  - b. Re-lubricate slide with specified grease until slide reservoir is full (minimum of 0.6 CC).
  - c. Allow full travel of the slide unit inside the actuator.
  - d. Cycle the slide 10-20 to re-circulate the grease.
2. After 3 months of normal operation:
  - a. Inspect interior of actuator for possible grease discharge.
  - b. Re-lubricate slide with specified grease until slide reservoir is full (minimum of 0.6 CC).
  - c. Allow full travel of the slide unit inside the actuator.
  - d. Cycle the slide 10-20 to re-circulate the grease.
3. After 6 months of normal operation:
  - a. Remove slide assembly from actuator.
  - b. Inspect the slide block and rail for damage or unusual wear.
  - c. Re-lubricate slide with specified grease until slide reservoir is full (minimum of 0.6 CC).
  - d. If slide is damaged or wear is apparent, contact BRANSON Metal Welding Customer Service.
  - e. Using a setup rail (BRANSON Metal Welding #105-355); slide the block the full length of the rail 5-10 times manually to re-circulate the rollers through the grease reservoir.
  - f. Re-assemble the slide assembly within the actuator.

If, after the 1st and 2nd inspections, the slide grease is abnormally low, has discoloration, or there is dust/dirt in the slide block, more frequent inspections will be required.

**Lubrication used:** Alvania EP Grease 2 (Shell) – Extreme Pressure Grease

**Grease fitting on slide:** IKO #B-M4 (BRANSON Metal Welding #209-336)

**Supply Nozzle:** IKO #A-8120V (BRANSON Metal Welding #209-337)

## 1.9 Recommended Spare Component Lists

### 1.9.1 Primary Spare Items

Items that are highly recommended to have readily available to prevent extended equipment down time and/or setup time.

**Table 1.3** Primary Spare Items

Part Number	Part Description	Additional Information
102-242-632R	PC Board	
100-246-1450	Linear Encoder	25mm Stroke
100-095-168	Spring, Front Diaphragm	
100-095-169	Spring, Rear Diaphragm	

### 1.9.2 Secondary Spare Items

Secondary Spare Items (optional items) are items that are recommended to have readily available to prevent extended equipment down time and/or setup time when maintenance is required.

**Table 1.4** Secondary Spare Items (Optional Items)

Part Number	Part Description	Additional Information
100-143-171	Valve Assembly	
100-246-1445	Electronic Pressure Regulator	
200-095-167	Spring, Extension	
100-034-088	Cylinder	
100-003-087	Slide Rail and Block	

## 1.10 Ultraweld 40 Tool Kit

**Table 1.5** Tool Kit (R3A00A68)

Part Number	Part Name	Qty	Comments
106-089A	SPANNER WRENCH, MODIFIED	1	
201-118-024	SPANNER WRENCH	1	
211-099	MOLYKOTE (GN PASTE) (TUBE)	1	
211-142	11/32" X 1/4" DRIVE SOCKET (FOR 40kHz TIP NUT)	1	
211-205	600 GRIT EMERY (SHEET)	1	
211-206	4-3/8" x 11" METAL FINISHING PAD	1	
211-250	3/8" TO 1/4" DRIVE SOCKET ADAPTER	1	
211-636	CANVAS BAG	1	
211-658	METRIC ALLEN HEX WRENCH SET (1.5mm-5mm)	1	
M1A50A42	0.0010" SHIM	4	
M1A50A45	1MM SPACER	1	
X3A50325	6MM SPACER	1	
211-079	Dial Indicator (use with Magnetic Base)	N/A	Optional Item Purchase Separately
211-127	3/8" Torque Wrench - 40kHz	N/A	Optional Item Purchase Separately
211-245	Magnetic Base (use with Dial Indicator)	N/A	Optional Item Purchase Separately

## 1.11 File Attachments

**Table 1.6** File Attachments

Description	Files
Assembly Drawing (Manufacturing & Commercial)	159-134-341
Footswitch	M1A00137
Cable, Automation Interface	J1A00230
Analog Data Cable	101-266R
Touchscreen Control Cable	101-640
Tool Kit	R3A00A68

REVISIONS					
ZONE	REV	DESCRIPTION	DATE	ECN/ECO	APPR.

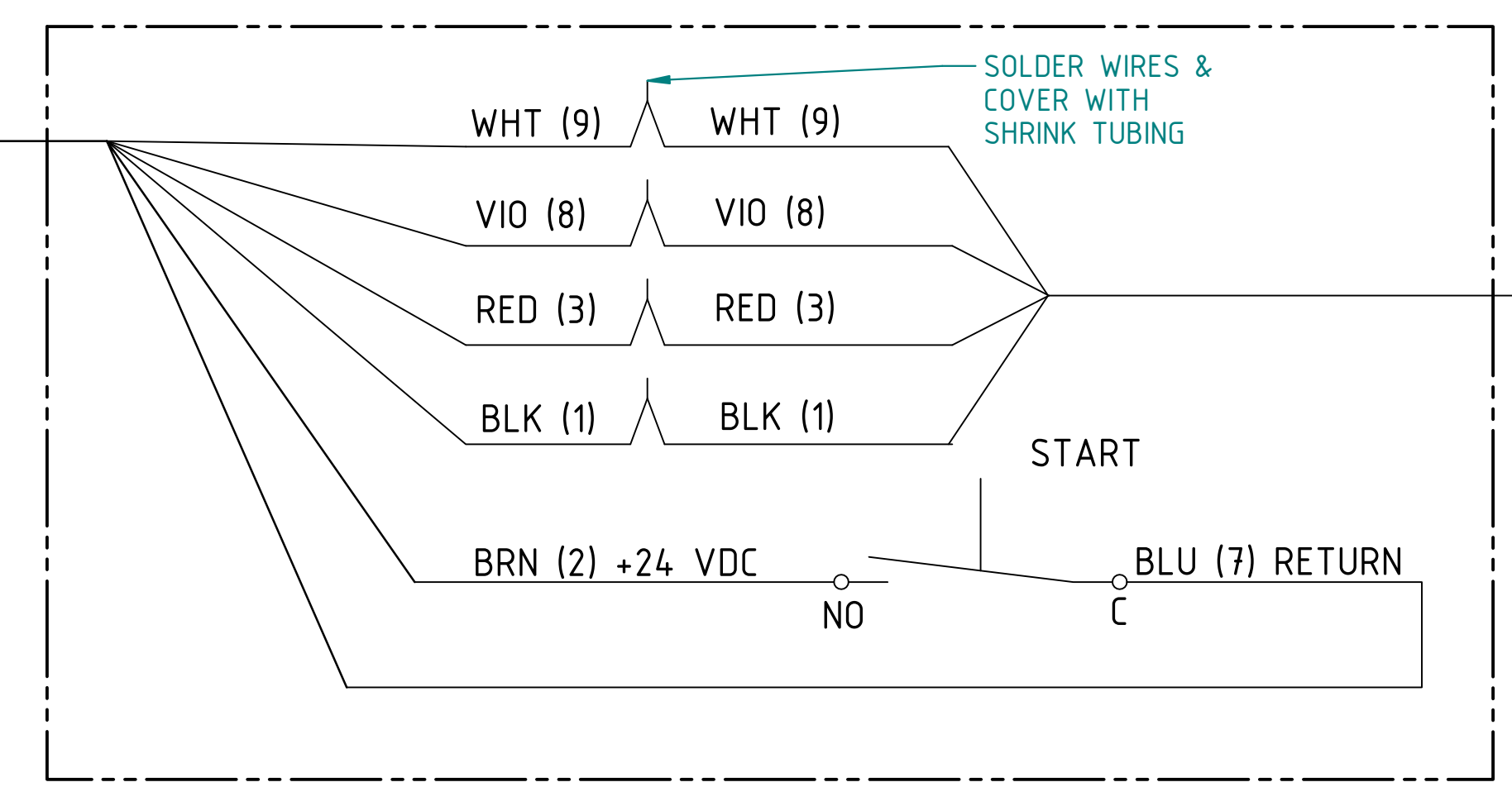
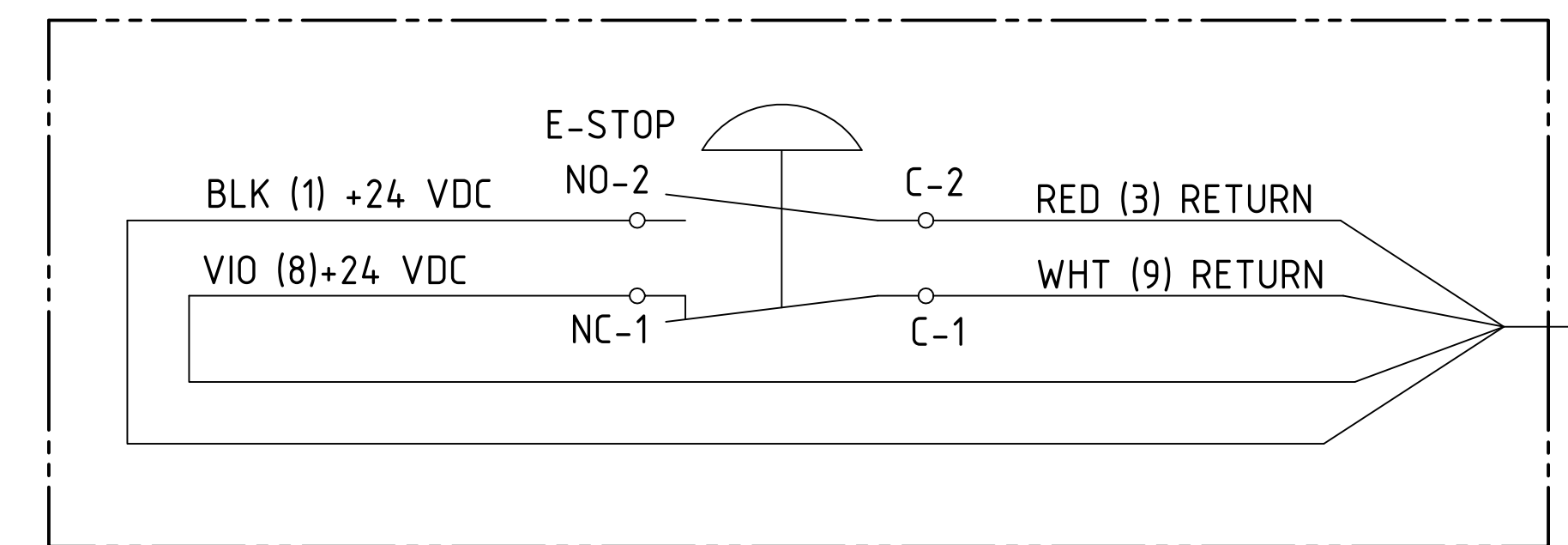
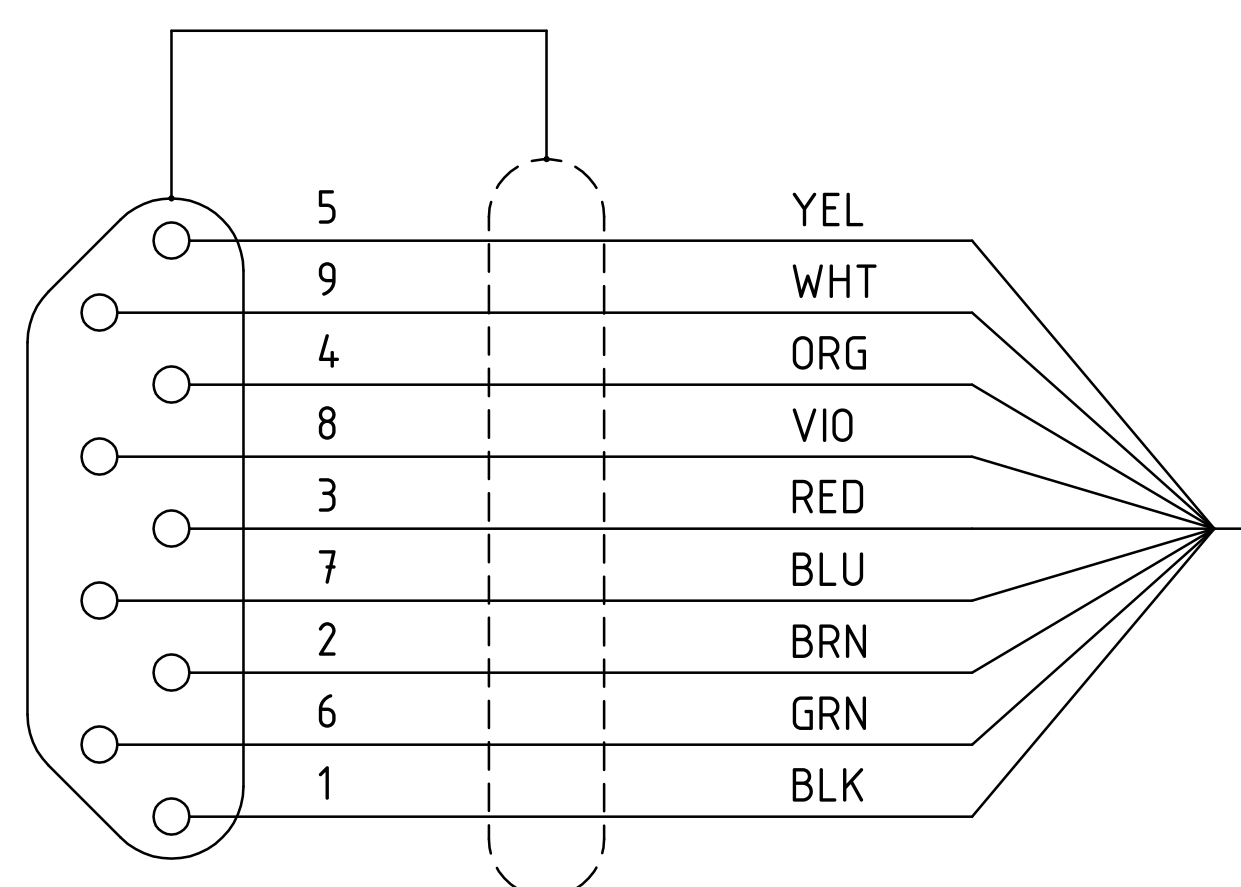
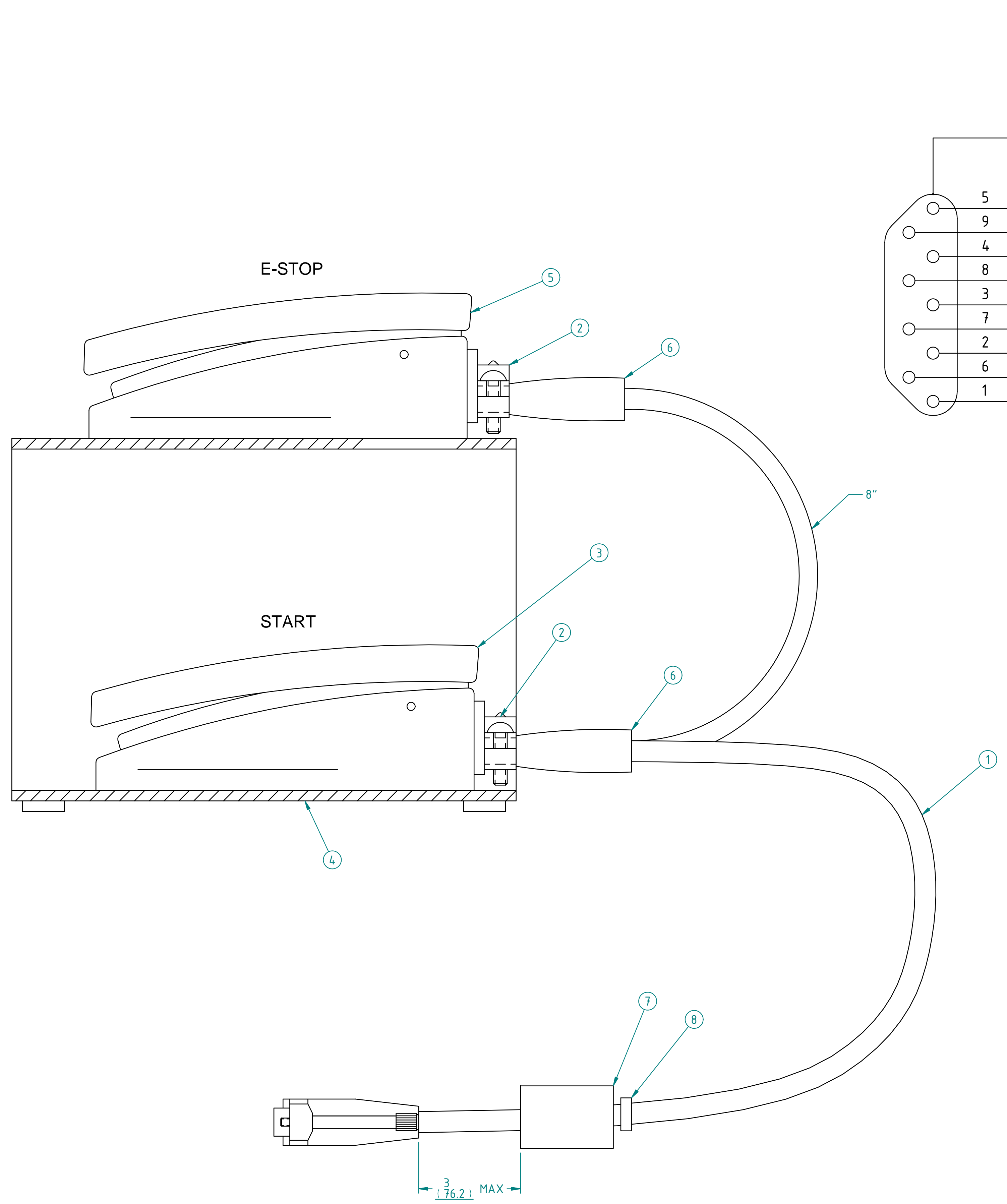

PARTS LIST				
ITEM	PART NUMBER	DESCRIPTION	QTY	REMARKS
1	101-216-8R	CABLE,8',9 PIN,J-00-013	1	
2	101-022R	BUSHING AMPHENOL 9779-513-8	2	
3	102-029	FOOTSWITCH LINEMASTER 632-S	1	
4	102-030	GUARD, LINEMASTER 522B14	1	
5	102-338	FOOTSWITCH LINEMASTER 634-DA	1	PAINT OUTSIDE SAFETY RED
6	101-023	BOOT,RUBBER,AMP#112,977951312	2	
7	200-031-036	CORE FERRITE W/CASE	1	
8	200-111-001	TYRAP 23M SMALL	1	

<small>UNLESS OTHERWISE SPECIFIED DIMENSIONS ARE IN INCHES AND TOLERANCES ARE: 2 PLACE DECIMALS ±.015 3 PLACE DECIMALS ±.005 ANGLES ±1° FRACTIONS ±1/32 SURFACE FINISH</small>	<small>This PROPRIETARY Document is property of Branson Ultrasonics Corp., Danbury, CT. It is confidential in nature, non-transferable, and issued with the clear understanding that it is not traced or copied without permission and is returnable upon demand.</small>	MATERIAL:					
		Material Spec.			NAME	DATE	
		FINISH:			DRAWN	dsulik	7/26/12
		3RD ANGLE PROJECTION			CHECKED	mdavis	7/26/12
SECONDARY DIMENSIONS ARE PROVIDED FOR REFERENCE ONLY	INCHES (MM)	APPROVED	dsulik	7/26/12			
		SCALE: 1:1	SHEET 1 OF 1	SIZE DWG NO			
		Finish Spec.		D			
				M1A00137			
				REV 00			

3 (76.2) MAX

SOLID EDGE

REVISIONS						
ZONE	ECN	REV	DESCRIPTION	DATE	REVISED	APPROVED
-	-	0	INITIAL RELEASE	1/29/2014	LAW	LAW
-	-	01	ADDED J1A00230-24	1/29/2014	MGD	MGD
-	-	02	ADDED J1A00230-100	3/25/2019	MGD	MGD

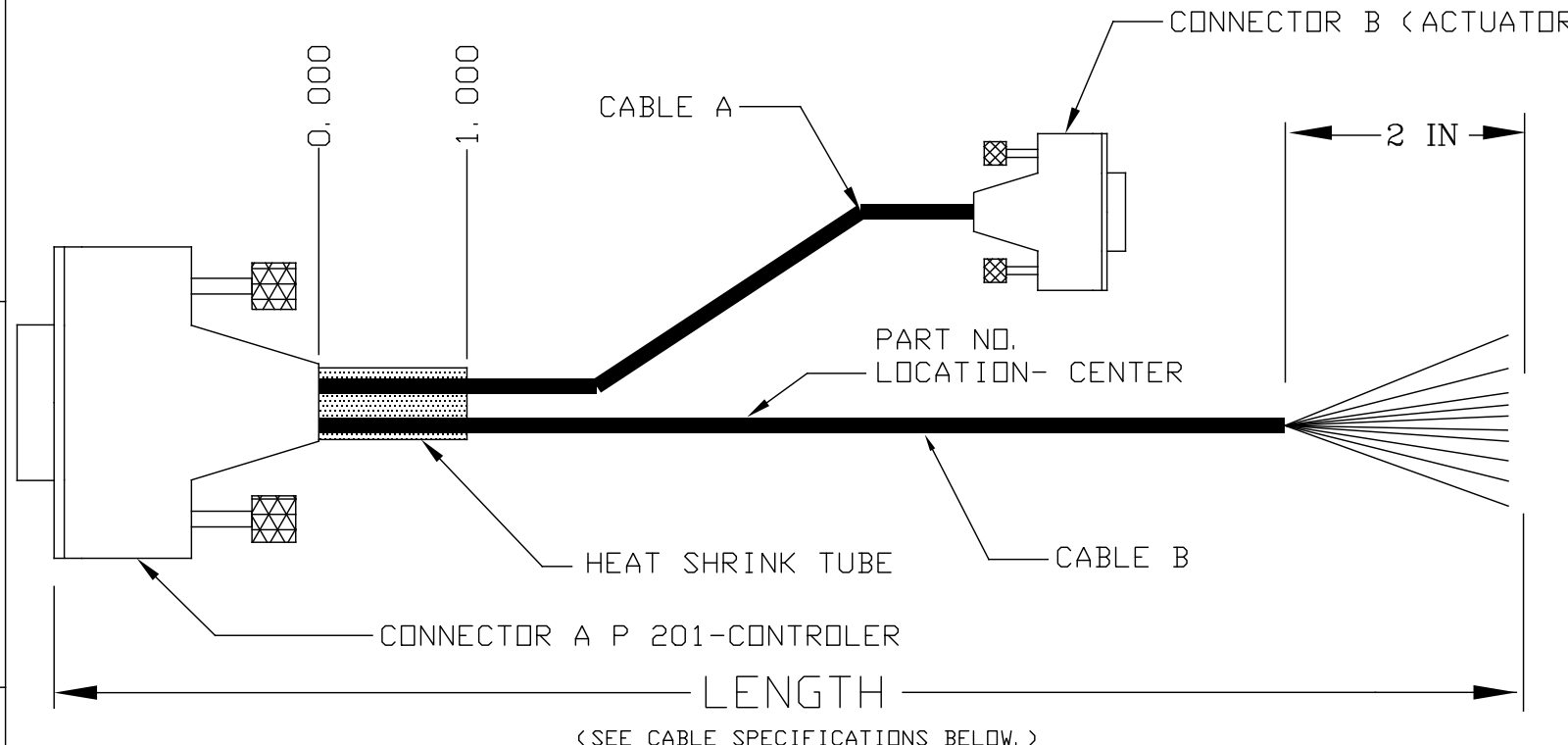

J1A00230 - CABLE SPECIFICATIONS				
CABLE	LENGTH	WIRE GAUGE	SHIELDING	CABLE TYPE
A	10.0ft	24 AWG (MIN)	NONE	BELDEN 9536
B	30.0ft	24 AWG (MIN)	NONE	BELDEN 9541

J1A00230-100 - CABLE SPECIFICATIONS				
CABLE	LENGTH	WIRE GAUGE	SHIELDING	CABLE TYPE
A	10.0ft	24 AWG (MIN)	NONE	BELDEN 9536
B	100.0ft	24 AWG (MIN)	NONE	BELDEN 9541

J1A00230-20 - CABLE SPECIFICATIONS				
CABLE	LENGTH	WIRE GAUGE	SHIELDING	CABLE TYPE
A	20.0ft	24 AWG (MIN)	NONE	BELDEN 9536
B	30.0ft	24 AWG (MIN)	NONE	BELDEN 9541

J1A00230-5 - CABLE SPECIFICATIONS				
CABLE	LENGTH	WIRE GAUGE	SHIELDING	CABLE TYPE
A	5.0ft	24 AWG (MIN)	NONE	BELDEN 9536
B	5.0ft	24 AWG (MIN)	NONE	BELDEN 9541

J1A00230-8 - CABLE SPECIFICATIONS				
CABLE	LENGTH	WIRE GAUGE	SHIELDING	CABLE TYPE
A	5.0ft	24 AWG (MIN)	NONE	BELDEN 9536
B	8.0ft	24 AWG (MIN)	NONE	BELDEN 9541

J1A00230-24 - CABLE SPECIFICATIONS				
CABLE	LENGTH	WIRE GAUGE	SHIELDING	CABLE TYPE
A	24.0ft	24 AWG (MIN)	NONE	BELDEN 9536
B	30.0ft	24 AWG (MIN)	NONE	BELDEN 9541

CONNECTOR SPECIFICATIONS			TERMINAL SPECS				
CONNECTOR NO.	OF CONTACTS	TYPE	MANUFACTURE	MFG P/N	AMTECH P/N	MFG P/N	AMTECH P/N
A	25-SOCKETS	RECEPT	AMP	207463-1		66504-3	101-258
B	15-SOCKETS	RECEPT	AMP	205205-2		66504-3	101-258
A	25	SHELL	AMP	5745173-1	101-790		
B	15	SHELL	AMP	748676-2	101-406		
A & B		JSCREW	AMP	747784-3	101-405		

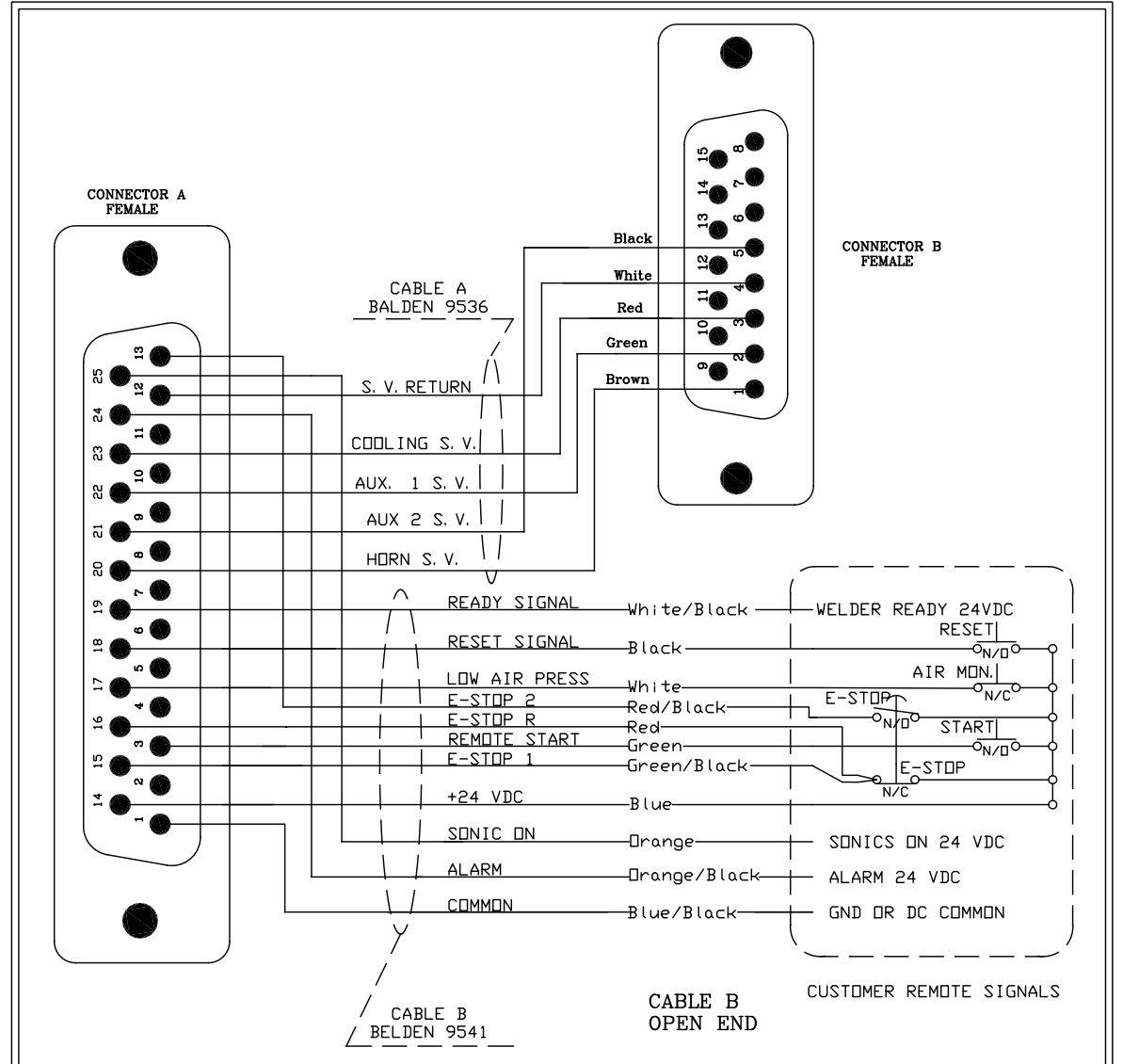

FILE PATH: E:\ENGINEERING APPROVED DRAWINGS\J\J1A00230.dwg

DRAWN	LAW	DATE	1-29-2014
CHECKED	LAW	DATE	1-29-2014
APPROVED	LAW	DATE	1-29-2014
SCALE: NTS	SHEET 1 of 2	PART NAME	CABLE, AUTOMATION INTERFACE
		USED ON ASSEMBLY	ASSY_NUMBER
		DRAWING NUMBER	J1A00230
		REV	02

This PROPRIETARY document is the property of Branson Ultrasonics Corp., Danbury, CT. It is confidential in nature, non-transferable and issued with the clear understanding that it is not traced or copied without permission and is returnable upon demand.

Handshaking and Remote Communications

HANDSHAKING Interface

For custom interface of the ULTRAWELD system, the following external signals are available from and to P201 utilizing Remote Start Cable J1A00230. All outputs go to 24 VDC when true and can drive a 600 ohm relay. All inputs except Emergency Stop are into a 2.2K ohm resistor. Emergency Stop is a 600 ohm relay load with a bypass diode in parallel with a 2.2K ohm resistor.

READY SIGNAL (Controller Output - White/Black wire)

Comes on at startup and after the weld cycle, by checking the horn height position. If the horn height is within 1 millimeter of the open height, the ready pin goes to true. If the welder is not equipped with a height encoder this signal is issued after the weld cycle is complete, when the horn is opened, and the sonic signal is turn off. Several hardware error conditions also put this output to false. Conditions that put this output to false generally will not allow the welder to run. SETUP mode also puts this false.

E-STOP 1 (Controller Input - Green/Black wire)

This pin must be at 24VDC for the control to run. If there is no 24VDC at this pin the hardware will prevent the control from running. The alarm signal will go true and the ready signal will go false. When the E-STOP 1 input is false the control automatically cancels all operations and all motions return to the rest position. The front panel shows "EMERGENCY STOP" when this signal is false.

E-STOP R (Controller Input - Red wire)

This pin must be at 24VDC for the control to run. If there is no 24VDC at this pin the hardware will prevent the control from running. The alarm signal will go true and the ready signal will go false. When the E-STOP R input is false the control automatically cancels all operations and all motions return to the rest position. The front panel shows "EMERGENCY STOP" when this signal is false.

E-STOP 2 (Controller Input - Red/Black wire)

This input was added for ISO13849 requirement. This N/O input must be from the same switch as E-STOP1 N/C input. If the E-STOP switch is actuated both E-STOP 1 and E-STOP 2 must change states.

Low Air Pressure (Controller Input - White wire)

Like the E-STOP, this pin must be held at 24VDC to keep the control running. If there is no 24VDC at these pins the hardware will prevent the control from running.

Alarm (Controller Output - Orange/Black wire)

Turns on if any alarms are found during the weld cycle. Will also come on if various other problems with the hardware are found.

24VDC Return or Common - Blue/Black wire

When a 24VDC input supply from customer is present this pin is to be tied to the dc power supply common of customer control for reference input.

Remote Start (Controller Input - Green wire)

A 300 millisecond 24VDC pulse at this pin will start the weld cycle. The weld cycle start will be ignored if the control is in any setup mode or the hardware check did not pass.

Reset Signal (Controller Input - Black wire)

If a weld quality error is found the control will not operate until all errors are cleared. The Alarms output will not clear until all errors are cleared one by one. This input will only clear quality alarms. Weld overload or hardware alarms can only be cleared or bypassed from the front panel.

Sonic ON (Controller Output - Orange wire)

This output comes on during the weld cycle while the sonics are actually ON.

+24VDC (Blue wire)

This source voltage, supplied by the controller, can be used to drive the handshaking inputs. This source can also be used for up to (2) 600 ohm loads to drive peripherals.

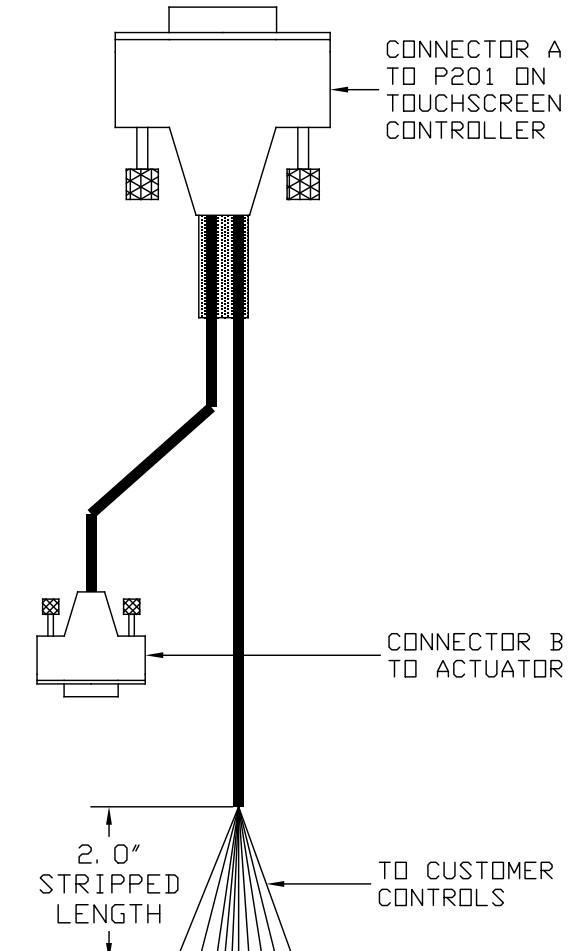
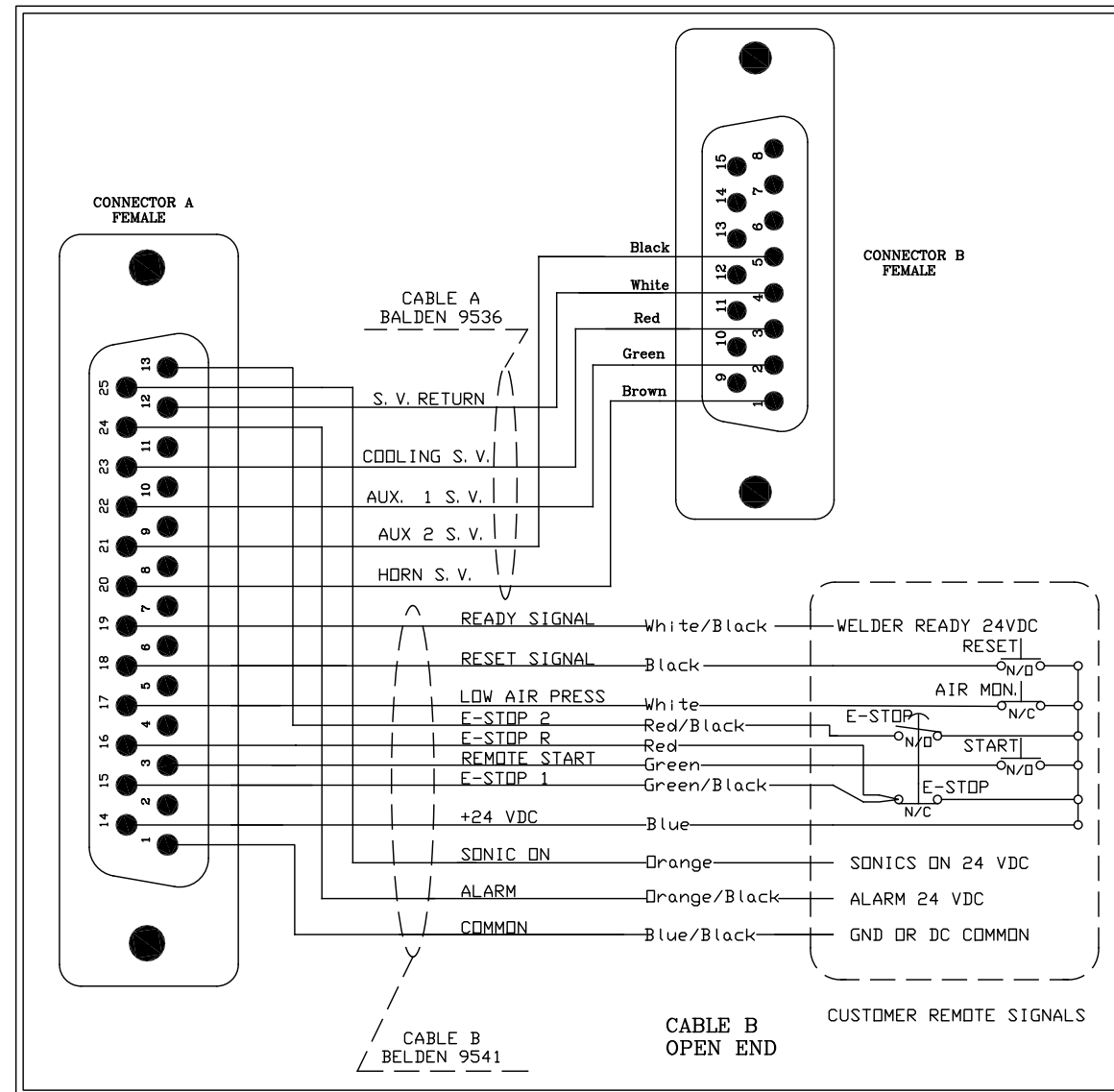
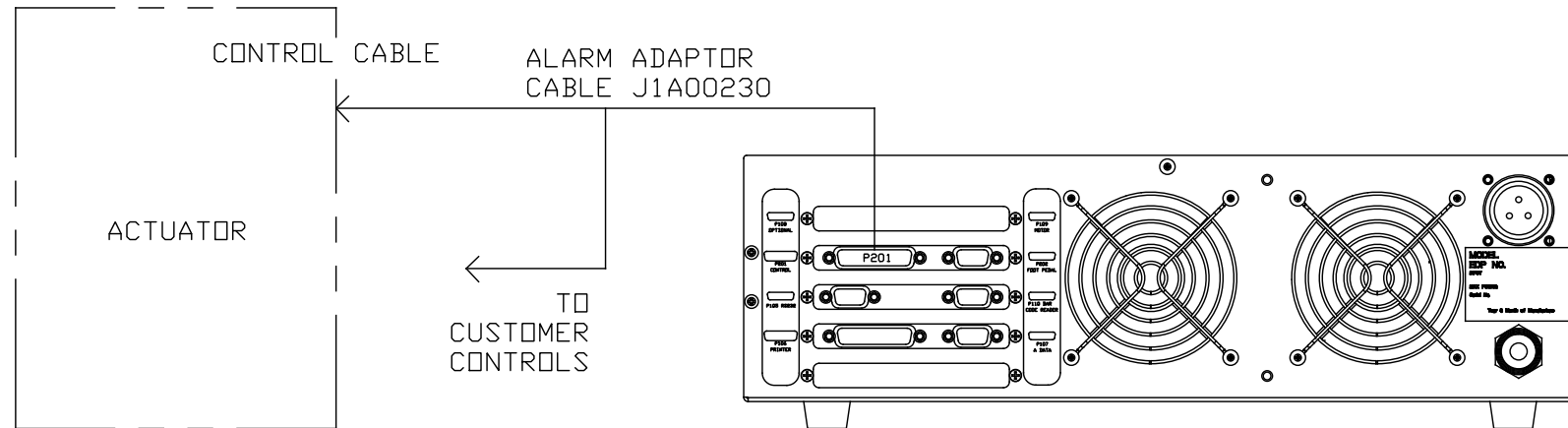

This PROPRIETARY document is the property of Branson Ultrasonics Corp., Danbury, CT. It is confidential in nature, non-transferable and issued with the clear understanding that it is not traced or copied without permission and is returnable upon demand.			
DRAWN	LAW	1-29-2014	PART NAME
CHECKED	LAW	1-29-2014	CABLE, AUTOMATION INTERFACE
APPROVED	LAW	1-29-2014	USED ON ASSEMBLY
SCALE: NTS	SHEET 2 of 2	DRAWING NUMBER	REV
		J1A00230	02

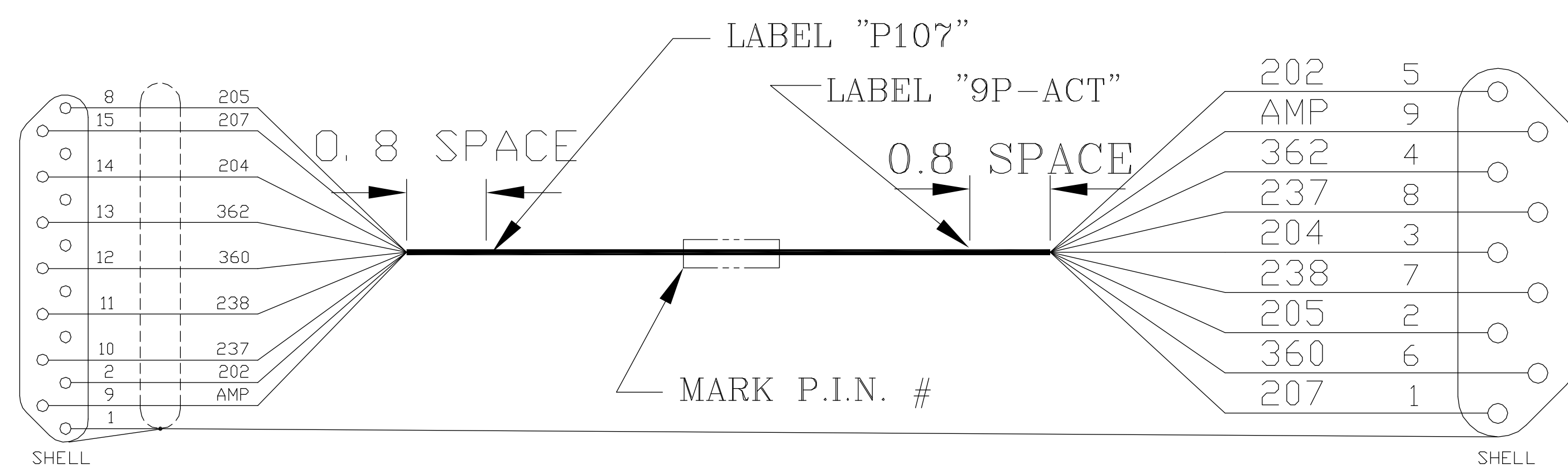
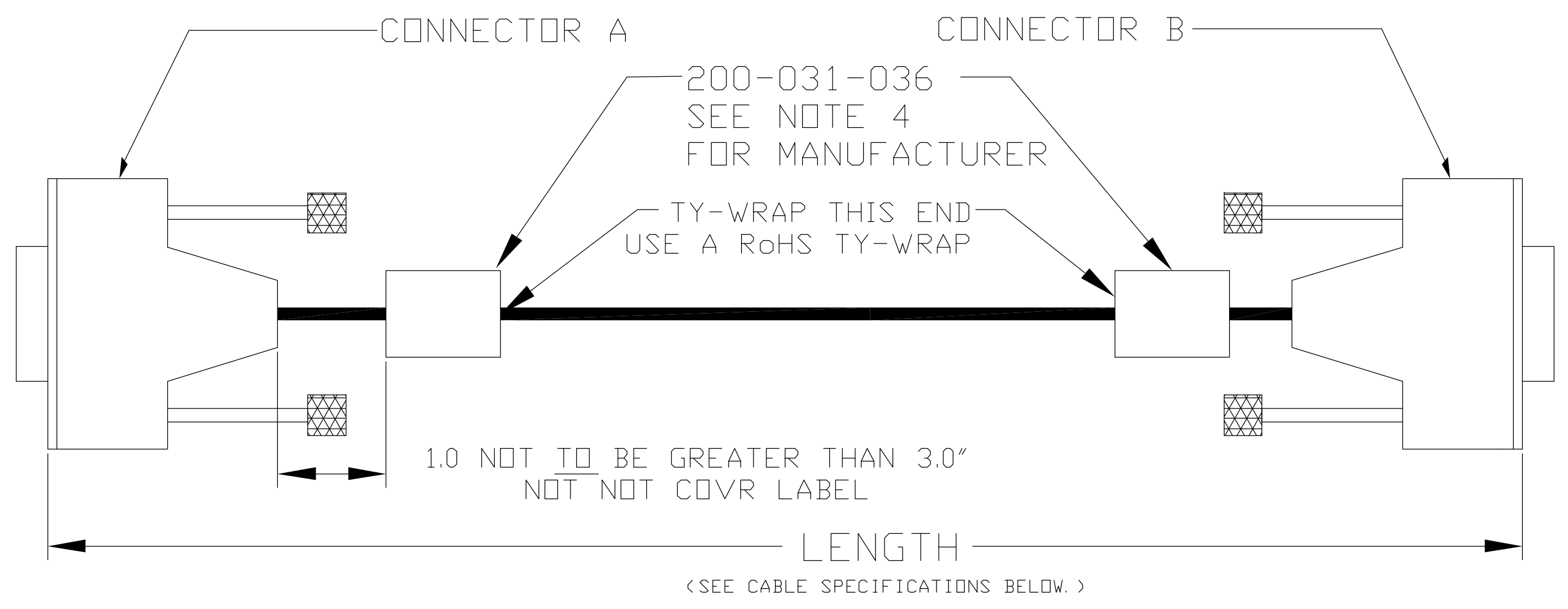
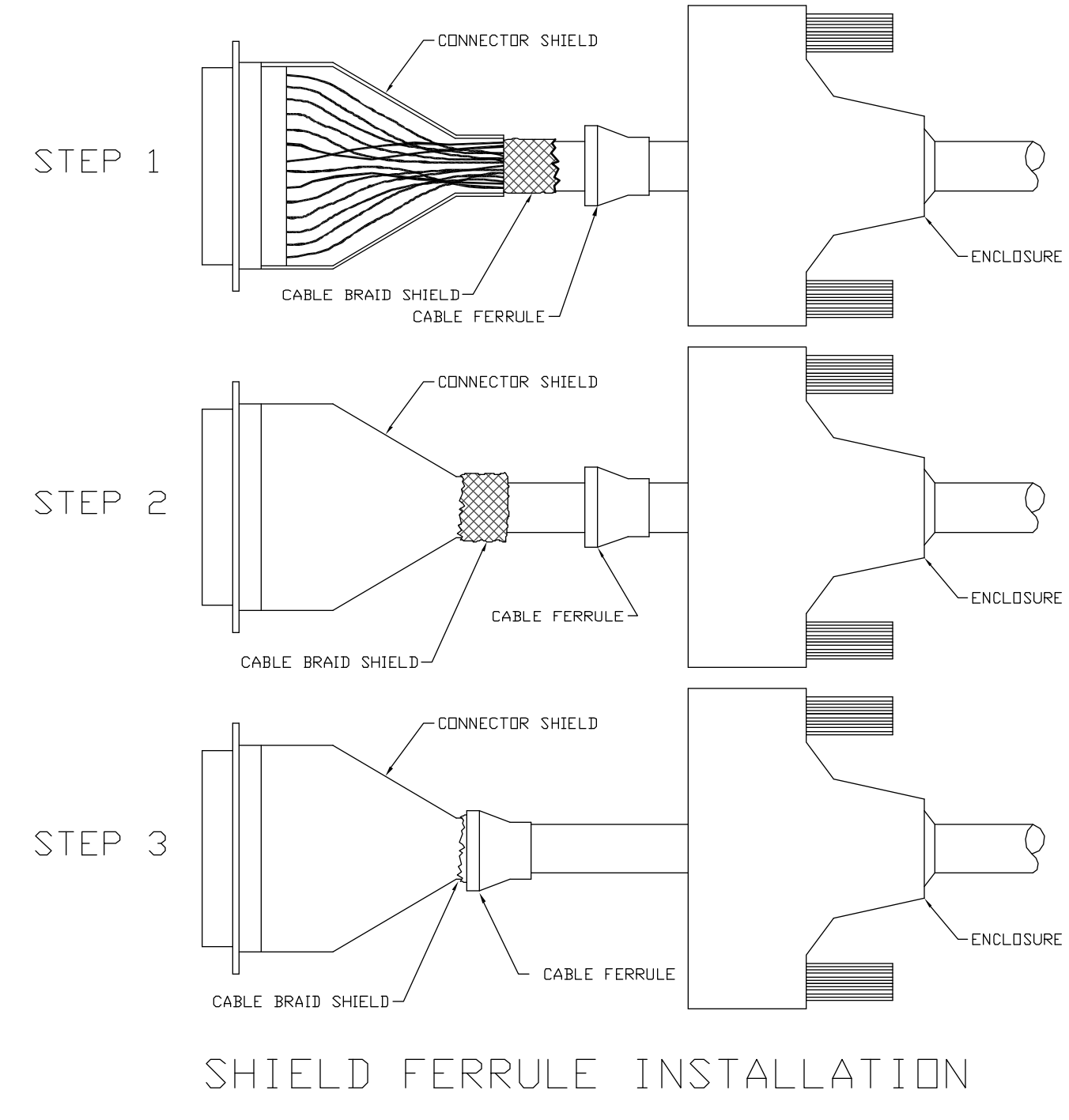

REVISIONS						
ZONE	ECN#	REV	DESCRIPTION	DATE	REVISED	APPROVED
-	-	1	INITIAL RELEASE	1-13-98	DB	-
-	1272	2	ADDED 101-266-5, NEW FORMAT	7-25-03	JC	MGD
-	2332	3	CHANGED A&B CONNECTOR: 1-747579-0 WAS 748676-2 (101-406) & 748676-1 (101-404) & 747784-3 (101-405) ADDED SHIELD FERRULE INSTALLATION DIAGRAM ADDED SHELL GROUND	01-10-06	MGD	-
-	1272	4	ADDED 101-266-8	02-28-06	JBM	-
-	2352	5	ADDED 200-031-036 FERRITES	03-13-06	JBM	-
-	2421	6	ADDED 101-266-21, 101-266-34 & 101-266-40 CORRECTED WIRE GAGE FOR BELDEN 9614 BELDEN 9614 IS 24 GAGE	06-15-06	LAW	-
-	17928	7	UPDATED PER RoHS COMPLIANT	01-23-08	JJF	YC

CONTACTS	SHIELD	MALE (PINS)	FEMALE (SOCKETS)
9	101-404R	101-202R	101-203R
15	101-406R	101-201R	101-204R
25	101-407R	101-209R	101-214R
	101-405R	JACK-SCREWS 1-SET = 2	

PART #	LENGTH	WIRE GAUGE	SHIELDING	CABLE TYPE
101-266R	10.0'	24 AWG	OVERALL	BELDEN 9614 (OR RoHS EQUIVALENT)
101-266-5R	5.0'	24 AWG	OVERALL	BELDEN 9614 (OR RoHS EQUIVALENT)
101-266-8R	8.0'	24 AWG	OVERALL	BELDEN 9614 (OR RoHS EQUIVALENT)
101-266-21R	21.0'	24 AWG	OVERALL	BELDEN 9614 (OR RoHS EQUIVALENT)
101-266-34R	34.0'	24 AWG	OVERALL	BELDEN 9614 (OR RoHS EQUIVALENT)
101-266-40R	40.0'	24 AWG	OVERALL	BELDEN 9614 (OR RoHS EQUIVALENT)

CONNECTOR SPECIFICATIONS						TERMINAL SPECIFICATIONS	
CONNECTOR	NO. OF CONTACTS	TYPE	MANUFACTURER	MFG P/N	AMTECH P/N	MFG P/N	AMTECH P/N
A	15-PINS	PLUG	AMP	1658657-1	101-262R	66506-3	101-257R
B	9-SOCKETS	RECEPT	AMP	1658654-1	-	66504-3	-
A & B	15 PINS	FERRULE	AMP	3-747579-2	-	-	-
-	-	-	-	-	-	-	-
-	-	-	-	-	-	-	-

- NOTES:
- ALL CONNECTORS MUST BE FULLY POPULATED.
  - LABEL CHARACTERS MUST BE AS LARGE AS POSSIBLE.
  - FOR PIG TAIL CONNECTION SEE DWG. J-0A-029.
  - FAIR RITE PRODUCTS #0443167251 SUPERCEDED J-00-015.
  - ASSEMBLY SHALL BE RoHS COMPLIANT.
  - REFER TO EDB FOR CURRENT APPROVED VENDORS.
  - NEW OR EQUIVQLENT COMPONENTS AND VENDORS SUBJECT TO BRANSON'S PCSA APPROVAL.

SHT QTY: 1 of 19	<p>The World Leader in Ultrasonic Metal Joining</p> <p>THIS PRINT IS THE PROPERTY OF AMERICAN TECHNOLOGY, Inc., AND REPRESENTS CONFIDENTIAL AND PROPRIETARY INFORMATION OF AMTECH, AND IT MAY NOT BE USED OR DISCLOSED IN ANY WAY WITHOUT THE EXPRESSED WRITTEN CONSENT OF AMTECH.</p> <p>PART NAME: ANALOG DATA CABLE</p>
SCALE: 1=1	
DRAWN ON: 1-13-98	
DRAWN BY: DB	
APPROVED BY:	
3RD ANGLE PROJECTION	USED ON ASSEMBLY:
DO NOT SCALE DRAWINGS	DRAWING NUMBER: 101-266-XXR
	REV: 7

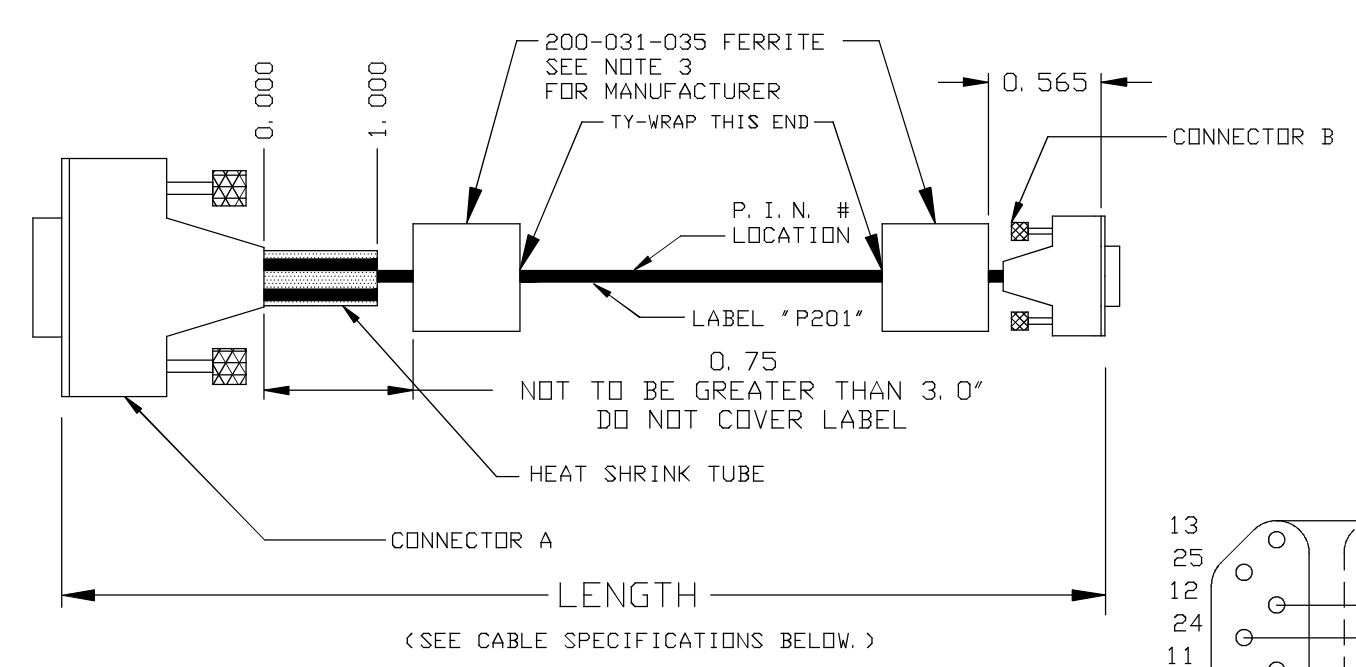
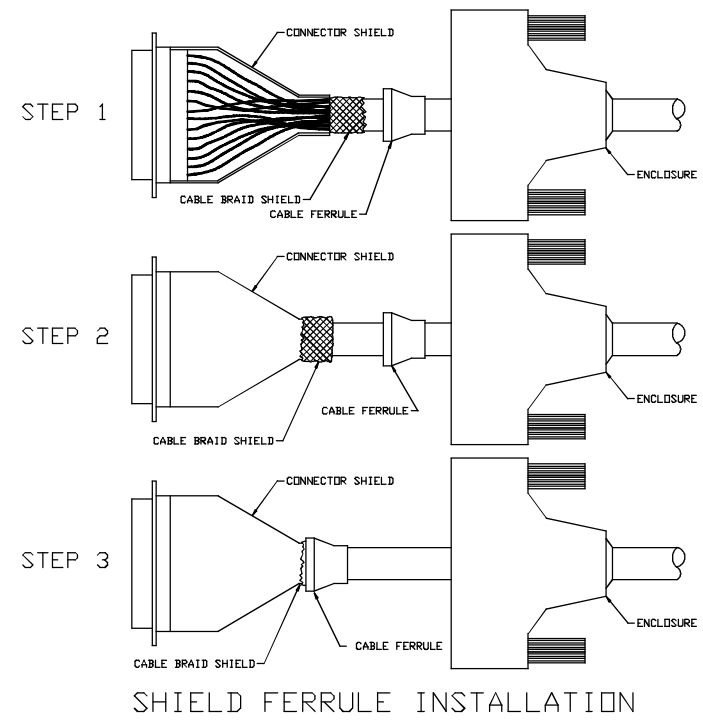

REVISIONS					
ZONE	ECN#	REV	DESCRIPTION	DATE	APPROVED
-	-	1	INITIAL RELEASE	-	-
-	1272	2	ADDED * NOTES FOR IN HOUSE ASSY.	5-7-03	J. C.
-	1272	3	ADDED 101-640-5 TO CHART	7-25-03	J. C.
-	2332	4	CHANGED CABLE TYPE TO 5120/20C WAS 5020/20C CHANGED A&B CONNECTOR: AMP 1-747579-1 WAS 748676-3 (101-404) & 748676-2 (101-406) & 747784-3 (101-405) ADDED SHIELD FERRULE INSTALLATION DIAGRAM ADDED SHELL GROUND	01-10-06	MGD
-	1272	5	ADDED 101-640-8 AND 101-640-24	02-28-06	JBM
-	2352	6	ADDED 200-031-035 FERRITES	03-13-05	JBM
-	1272	7	ADDED 101-640-21 TO CHART	2008-11-12	MGD
-	-	8	ADDED 101-640-30 TO CHART	03-18-2014	LAW
-	20783	9	ADDED 101-640-16 TO CHART	08-13-2014	SB

- NOTES:**
1. ALL CONNECTORS MUST BE FULLY POPULATED.
  2. LABEL LOCATIONS ARE APPROXIMATE.
  3. CABLE MUST BE CONSPICUOUSLY MARKED AS FOLLOWS:
  4. FAIR RITE PRODUCTS #0443164151

CABLE USAGE:	
1	CONTROL CABLE -- TOUCHSCREEN & INTEG. SYSTEMS (P201 TO ACTUATOR.)

CABLE SPECIFICATIONS				
P. I. N. #	LENGTH	WIRE GAUGE	SHIELDING	CABLE TYPE
101-640	10. 0'	24 AWG	NONE	ALPHA 5120/20C (OR EQUIVALENT)
101-640-5	5. 0'	24 AWG	NONE	ALPHA 5120/20C (OR EQUIVALENT)
101-640-8	8. 0'	24 AWG	NONE	ALPHA 5120/20C (OR EQUIVALENT)
101-640-16	16. 0'	24 AWG	NONE	ALPHA 5120/20C (OR EQUIVALENT)
101-640-21	21. 0'	24 AWG	NONE	ALPHA 5120/20C (OR EQUIVALENT)
101-640-24	24. 0'	24 AWG	NONE	ALPHA 5120/20C (OR EQUIVALENT)
101-640-30	30. 0'	24 AWG	NONE	ALPHA 5120/20C (OR EQUIVALENT)

CONNECTOR SPECIFICATIONS						TERMINAL SPECIFICATIONS	
CONNECTOR	NO. OF CONTACTS	TYPE	MANUFACTURER	MFG P/N	AMTECH P/N	MFG P/N	AMTECH P/N
A	25-SOCKETS	SOCKETS	AMP	747955-1	*101-263	66504-3	*101-258
B	15-SOCKETS	SOCKETS	AMP	747953-1	**101-261	66504-3	**101-258
A&B	-	FERRULE	AMP	1-747579-1	-	-	-
-	-	-	-	-	-	-	-
-	-	-	-	-	-	-	-

- NOTE:**
1. \*101-263 & 101-258 REPLACED BY (1) 101-214 25 FEMALE CONN. WHEN MADE IN HOUSE AT AMTECH
  2. \*\*101-261 & 101-258 REPLACED BY (1) 101-204 15 FEMALE CONN. WHEN MADE IN HOUSE AT AMTECH

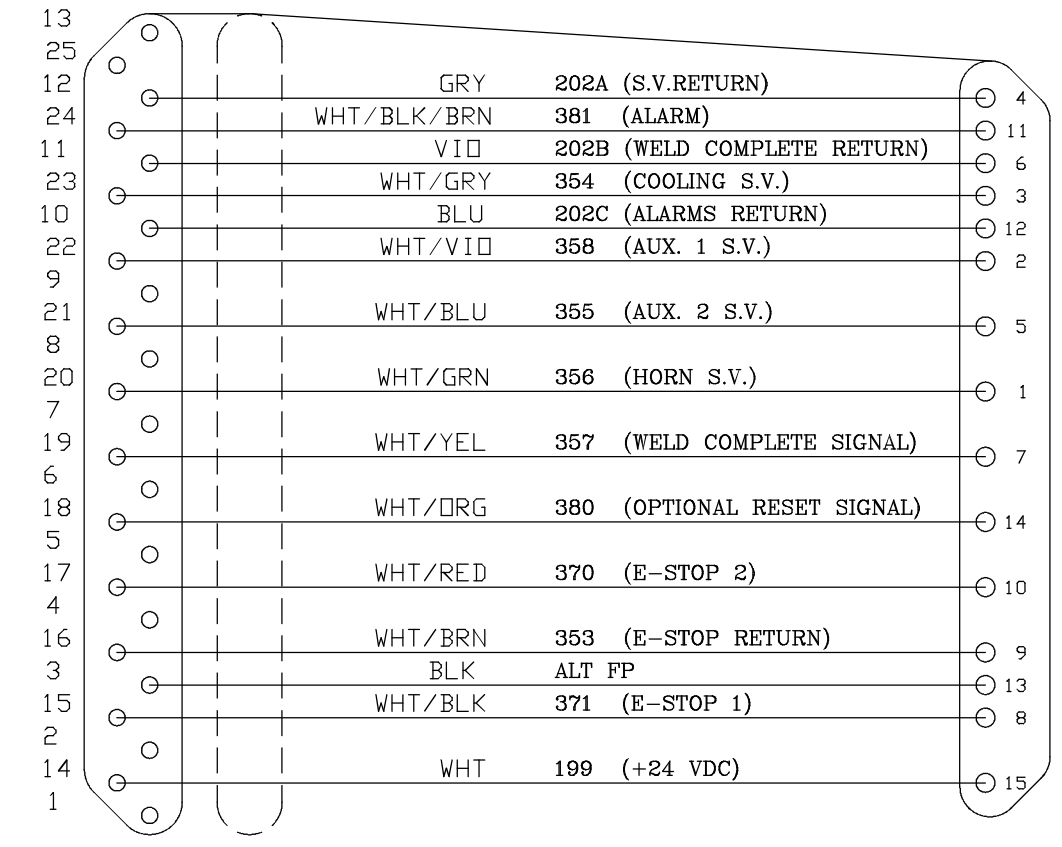

		Z:\LOGOS\Branson_logo_large.bmp	
DRAWN JC 03/05/2003 CHECKED JC 03/05/2003 APPROVED JC 03/05/2003 SCALE: NTS SHEET 1 of 1		This PROPRIETARY document is the property of Branson Ultrasonics Corp., Danbury, CT. It is confidential in nature, non-transferable and issued with the clear understanding that it is not traced or copied without permission and is returnable upon demand. PART NAME: TOUCHSCREEN CNTRL CABLE USED ON ASSEMBLY: STANDARD DRAWING NUMBER: 101-640-___ REV: 9	



Original Instructions  
100-412-180 - REV. 13

**EMERSON**<sup>™</sup>



# MWX100

## VersaGraphix Controller

# Operating Manual

**Branson Ultrasonics Corp.**  
120 Park Ridge Road  
Brookfield, CT 06804  
(203) 796-0400  
<http://www.bransonultrasonics.com>

**BRANSON**



## **Manual Change Information**

At Branson, we strive to maintain our position as the leader in ultrasonics metal welding, plastics joining, cleaning, and related technologies by continually improving our circuits and components in our equipment. These improvements are incorporated as soon as they are developed and thoroughly tested.

Information concerning any improvements will be added to the appropriate technical documentation at its next revision and printing. Therefore, when requesting service assistance for specific units, note the Revision information found on this document, and refer to the printing date which appears on this page.

## **Copyright and Trademark Notice**

Copyright © 2025 Branson Ultrasonics Corporation.  
All rights reserved.

Contents of this publication may not be reproduced in any form without the written permission of Branson Ultrasonics Corporation.

Windows 10 IoT Enterprise LTSC is a registered trademark of Microsoft Corporation.  
WD-40 is a registered trademark of WD-40 Manufacturing Company Corporation.

Other trademarks and service marks mentioned herein are held by their respective owners.

## Foreword

Congratulations on your choice of a Branson Metal Welding system!

The Branson VersaGraphix Series system is process equipment for the joining of metal parts using ultrasonic energy. It is the newest generation of product using this sophisticated technology for a variety of customer applications. This Operating Manual is part of the documentation set for this system, and should be kept with the equipment.

Thank you for choosing Branson!

## Introduction

This manual is arranged into several structured chapters which will help you find the information you may need to know to safely handle, install, set up, program, operate, and/or maintain this product. Please refer to the [Table Of Contents](#) of this manual to find the information you may be looking for. In the event you require additional assistance or information, please contact our Product Support department (see [1.4 How to Contact Branson](#) for information on how to contact them) or your local Branson representative.

---

# Table Of Contents

---

## Chapter 1: Safety and Support

1.1	Safety Requirements and Warnings . . . . .	2
1.2	General Precautions . . . . .	4
1.3	Warranty . . . . .	7
1.4	How to Contact Branson . . . . .	8
1.5	Returning Equipment for Repair . . . . .	9
1.6	Obtaining Replacement Parts . . . . .	12

## Chapter 2: The Branson VersaGraphix Controller

2.1	About this Operating Manual . . . . .	14
2.2	Model Covered . . . . .	15
2.3	Overview of this Model . . . . .	16
2.4	Compatibility with Branson Products . . . . .	17
2.5	Ultrasonic Theory . . . . .	18
2.6	Terminology . . . . .	24

## Chapter 3: Shipping and Handling

3.1	Shipping and Handling . . . . .	28
3.2	Receiving . . . . .	29
3.3	Unpacking . . . . .	30
3.4	Returning Equipment . . . . .	31

## Chapter 4: Technical Specifications

4.1	Environmental Requirements . . . . .	34
4.2	Electrical Requirements . . . . .	35
4.3	Pneumatic Requirements . . . . .	36
4.4	Operating System . . . . .	37

## Chapter 5: Operation

5.1	Before You Begin . . . . .	40
5.2	Pop Up Alphanumeric Keypad . . . . .	41
5.3	Pop Up Numeric Keypad . . . . .	42
5.4	Editing Buttons . . . . .	43
5.5	Pull Down Menus . . . . .	44
5.6	Create New Preset . . . . .	48
5.7	Create New Sequence . . . . .	50
5.8	Edit Sequence . . . . .	52
5.9	File Manager . . . . .	54
5.10	Run Menu . . . . .	57
5.11	Options Menu . . . . .	68
5.12	Remote Data Collection . . . . .	75
5.13	View Menu . . . . .	79
5.14	Help Menu . . . . .	83
5.15	Language Support . . . . .	84

## Chapter 6: Maintenance

6.1	Maintenance . . . . .	86
6.2	Preventive Maintenance . . . . .	87
6.3	Parts List . . . . .	88
6.4	Parts Replacement . . . . .	89
6.5	Troubleshooting . . . . .	90
6.6	Service Events . . . . .	92

# List Of Figures

## Chapter 1: Safety and Support

### Chapter 2: The Branson VersaGraphix Controller

Figure 2.1	How does Ultrasonic Welding Work? . . . . .	18
Figure 2.2	Weld Power Graph for clean components, dirty components, and when part is missing . . . . .	20
Figure 2.3	Pressure Variable with Increased Power . . . . .	20
Figure 2.4	Pressure Variable with Increased Time . . . . .	21
Figure 2.5	Scrubbing Action on Weld Interface . . . . .	21
Figure 2.6	Amplitude's Influence on Weld Power and Time . . . . .	22
Figure 2.7	Amplitude Stepping Profile . . . . .	22
Figure 2.8	Harmonic Resonance on Ultrasonic Tooling . . . . .	23

## Chapter 3: Shipping and Handling

### Chapter 4: Technical Specifications

### Chapter 5: Operation

Figure 5.1	Pop up Alphanumeric Keypad . . . . .	41
Figure 5.2	Pop up Numeric Keypad . . . . .	42
Figure 5.3	File Menu . . . . .	44
Figure 5.4	Run Menu . . . . .	45
Figure 5.5	Options Menu . . . . .	46
Figure 5.6	View Menu . . . . .	46
Figure 5.7	Help Menu . . . . .	47
Figure 5.8	Branson Logo . . . . .	47
Figure 5.9	VersaGraphix File Manager Screen . . . . .	54
Figure 5.10	Operator Screen (When Running a Preset) . . . . .	57
Figure 5.11	Unsuccessful welds pop up window for maximum height . . . . .	58
Figure 5.12	Operator Screen (When Running a Sequence) . . . . .	58
Figure 5.13	Unsuccessful welds pop up window for minimum height . . . . .	59
Figure 5.14	Setup Screen (When Running a Preset) . . . . .	59
Figure 5.15	Result taller than maximum height message . . . . .	60
Figure 5.16	Advanced Settings screen . . . . .	61
Figure 5.17	Setup Screen (When Running a Sequence) . . . . .	63
Figure 5.18	Result taller than minimum height message . . . . .	64
Figure 5.19	Sigma markers . . . . .	67
Figure 5.20	Actuator set up screen . . . . .	68
Figure 5.21	Default Preset settings screen . . . . .	69
Figure 5.22	Teach Mode Settings screen . . . . .	70
Figure 5.23	System Configuration screen . . . . .	71
Figure 5.24	COM settings screen . . . . .	72
Figure 5.25	Current IP Configuration display . . . . .	74
Figure 5.26	Main Menu . . . . .	76
Figure 5.27	Weld Graph . . . . .	79
Figure 5.28	Statistical Analysis screen . . . . .	80
Figure 5.29	Error Log . . . . .	81
Figure 5.30	Weld History . . . . .	81
Figure 5.31	VersaGraphix Software version . . . . .	83

Figure 5.32 Language Settings . . . . .	84
---	----

## **Chapter 6: Maintenance**

Figure 6.1 VersaGraphix Controller . . . . .	88
Figure 6.2 Maintenance Screen . . . . .	93
Figure 6.3 Height Calibration . . . . .	94
Figure 6.4 Test Sonics . . . . .	95
Figure 6.5 Maintenance Counters. . . . .	96
Figure 6.6 Maintenance Limits . . . . .	97
Figure 6.7 Maintenance Log . . . . .	98
Figure 6.8 Administrator Options Tab. . . . .	99
Figure 6.9 Rename Aux Buttons. . . . .	100
Figure 6.10 Administrator screen. . . . .	100
Figure 6.11 Administrator Password List Table . . . . .	101

---

## List Of Tables

---

### Chapter 1: Safety and Support

Table 1.1	Symbols found on the product . . . . .	3
-----------	--	---

### Chapter 2: The Branson VersaGraphix Controller

Table 2.1	VersaGraphix Controller compatibility with Branson Metal Welding Converters . . . . .	17
Table 2.2	Calculating Power . . . . .	19
Table 2.3	Calculating Energy. . . . .	19

### Chapter 3: Shipping and Handling

Table 3.1	Environmental Requirements for Shipping . . . . .	28
Table 3.2	Inspect the VersaGraphix Controller upon delivery . . . . .	29
Table 3.3	When unpacking the Controller, take the following steps . . . . .	30

### Chapter 4: Technical Specifications

Table 4.1	Environmental Requirements . . . . .	34
Table 4.2	Electrical Input Operating Voltages . . . . .	35
Table 4.3	Input Current and Fuse Requirements . . . . .	35

### Chapter 5: Operation

Table 5.1	Steps to create a new Preset . . . . .	48
Table 5.2	Steps to create a new Sequence . . . . .	50
Table 5.3	Steps to edit existing presets from the Edit Sequence Screen . . . . .	52
Table 5.4	To copy files from the Application Directory to the Browse Directory . . . . .	54
Table 5.5	To copy files from the Browse Directory to the Application Directory . . . . .	54
Table 5.6	To move files from the <b>Application Directory</b> to the <b>Browse Directory</b> . . . . .	<b>55</b>
Table 5.7	To move files from the <b>Browse Directory</b> to the <b>Application Directory</b> . . . . .	<b>55</b>
Table 5.8	To delete files from the either the Application Directory or the Browse Directory. . . . .	56

### Chapter 6: Maintenance

Table 6.1	Suggested Spares . . . . .	88
Table 6.2	System Alarms, with probable cause and corrective action . . . . .	90



---

# Chapter 1: Safety and Support

---





<b>1.1</b>	<b>Safety Requirements and Warnings</b> . . . . .	<b>2</b>
<b>1.2</b>	<b>General Precautions</b> . . . . .	<b>4</b>
<b>1.3</b>	<b>Warranty</b> . . . . .	<b>7</b>
<b>1.4</b>	<b>How to Contact Branson</b> . . . . .	<b>8</b>
<b>1.5</b>	<b>Returning Equipment for Repair</b> . . . . .	<b>9</b>
<b>1.6</b>	<b>Obtaining Replacement Parts</b> . . . . .	<b>12</b>

## 1.1 Safety Requirements and Warnings

This chapter contains an explanation of the different Safety Notice symbols and icons found both in this manual and on the product itself and provides additional safety information for ultrasonic welding. This chapter also describes how to contact Branson for assistance.

### 1.1.1 Symbols found in this Manual



These symbols used throughout the manual warrant special attention:

<b>WARNING</b>	<b>Indicates a possible danger</b>
	If these risks are not avoided, death or severe injury might result.
<b>CAUTION</b>	<b>Indicates a possible danger</b>
	If these risks are not avoided, slight or minor injury might result.
<b>NOTICE</b>	<b>Indicates a possible damaging situation</b>
	<p>If this situation is not avoided, the system or something in its vicinity might get damaged.</p> <p>Application types and other important or useful information are emphasized.</p>
<b>CAUTION</b>	<b>Corrosive Material Hazard</b>
	<p>First aid measures (in case of electrolyte leakage from the battery)            Eye Contact: Flush the eyes with plenty of clean water for at least 15 minutes immediately, without rubbing. Get immediate medical treatment.</p> <p>If appropriate procedures are not taken, this may cause eye injury.</p> <p>Skin Contact: Wash the affected area under tepid running water using a mild soap. If appropriate procedures are not taken, this may cause sores on the skin. Get medical attention if irritation develops or persists.</p> <p>Inhalation: Remove to fresh air immediately. Get medical treatment immediately.</p>

### 1.1.2 Symbols found on the Product

The VersaGraphix Controller has several warning labels on it to indicate the presence of hazardous voltages inside the unit.

**Table 1.1** Symbols found on the product

Symbol	Description
	Warning. Ground the unit before operating.
	High Voltage. Risk of electric shock or burn. Do not remove cover. Refer service to qualified personnel only.

## 1.2 General Precautions

Take the following precautions before servicing the VersaGraphix:

- Be sure the power switch is in the Off position before making any electrical connections
- To prevent the possibility of an electrical shock, always plug the VersaGraphix into a grounded power source
- Power supplies produce high voltage. Before working on the VersaGraphix module, do the following:
  - Turn off the VersaGraphix;
  - Unplug main power; and
  - Allow at least 2 minutes for capacitors to discharge
- High voltage is present in the VersaGraphix Controller. Do not operate with the cover removed
- High line voltages exist in the ultrasonic VersaGraphix module. Common points are tied to circuit reference, not chassis ground. Therefore, use only non-grounded, battery-powered multimeters when testing these modules. Using other types of test equipment can present a shock hazard
- Be sure power is disconnected from the VersaGraphix before setting a DIP switch
- Keep hands from under the horn. Down force (pressure) and ultrasonic vibrations can cause injury
- Do not cycle the welding system if either the RF cable or converter is disconnected

WARNING	
	<p>Sound level emissions of up to 84.9 dB have been measured using a standard test load. To prevent the possibility of hearing loss, use appropriate hearing protection.</p>

NOTICE	
	<p>Sound level and frequency of the noise emitted during the ultrasonic assembly process may depend upon <b>a.</b> type of application, <b>b.</b> size, shape and composition of the material being assembled, <b>c.</b> shape and material of the holding fixture, <b>d.</b> welder setup parameters and <b>e.</b> tool design. Some parts vibrate at an audible frequency during the process. Some or all of these factors may result in sound levels of up to 84.9 dB. In such cases operators may need to be provided with personal protective equipment. See 29 CFR (Code of Federal Regulations) 1910.95 Occupational Noise Exposure. For all other countries, follow your local regulations.</p>

NOTICE	
	<p>Because the Branson SBC Controller runs on a Windows 10 IoT Enterprise LTSC<sup>a</sup> based PC Platform, it is susceptible to computer viruses. Reasonable steps have been taken to protect our software but all customers are advised to take all necessary steps to ensure that no virus contamination occurs. Do not attempt to run any applications other than the Branson SBC Controller application. If you chose to connect the SBC controller to a computer network, added precautions must be taken in the form of firewalls, etc. No liability will be accepted for any loss or damage sustained as a consequence of any virus transmission.</p>

a. Windows 10 IoT Enterprise LTSC is a registered trademark of Microsoft Corporation.

### 1.2.1 Intended Use of the System

The Branson VersaGraphix Controller and Actuator are components of an ultrasonic welding system. These are designed for a wide variety of welding or processing applications. Branson is not liable for damages that arise due to non-intended use.

### 1.2.2 Regulatory Compliance

The Branson products (VersaGraphix Controllers, Welders and Splicers) are designed to be in compliance with the following U.S. regulatory and agency guidelines and standards:

- ANSI Z535.1 Safety Color Code
- ANSI Z535.3 Criteria for Safety Symbols
- ANSI Z535.4 Product Safety Signs and Labels
- ANSI Z535.6 Product Safety Information in Product Manuals, instructions, and other collateral materials
- NFPA 70 National Electric Code Article 670 Industrial Machinery
- NFPA 79 Electrical Standard for Industrial Machinery
- UL 61010-1
- CSA 22.2 No. 61010-1
- 29 CFR 1910.212 OSHA General Requirements for all machines
- 47 CFR Part 18 Federal Communications Commission

Branson products (VersaGraphix Controllers, Welders and Splicers) are designed to be in compliance with the following listed European standards as specified by the Directives issued by the European Parliament and The Council of the European Union:

- Machinery Directive 2006/42;
- Low Voltage Directive 2014/35/EU
- EMC Directive 2014/30/EU
- BS EN ISO 13850 Safety of Machinery - Emergency stop equipment, Functional aspects - Principles for design
- EN 13849-1 Safety of Machinery - Safety of related parts of control systems
- EN ISO 12100 Safety of Machinery - Risk assessment - Part 1: Principles
- EN 55011 Limits and methods of measurement of radio disturbance of industrial, scientific and medical radio-frequency equipment
- EN 60204-1 Safety of Machinery - Electrical Equipment of machines
- EN 61000-3-2 Electromagnetic Compatibility - Limits for harmonic emissions (For European products that draw less than 1000 watts from the line at full rated power)

- EN 61000-3-3 Electromagnetic Compatibility - Limitations of voltage fluctuations and flicker in low voltage supply systems (For European products that draw less than 1000 watts from the line at full rated power)
- EN 61000-6-1 Electromagnetic Compatibility - Generic standards - Immunity for residential, commercial and light-industrial environments (For European products that draw less than 1000 watts from the line at full rated power)
- EN 61000-6-2 Electromagnetic Compatibility - Generic standards - Immunity for industrial environments
- EN 61310-2 Safety of Machinery - Indication, marking, actuation
- All products with CE Mark require: Same as above plus



## 1.3 Warranty

For warranty information please reference the warranty section of Terms and Conditions found at: [www.emerson.com/branson-terms-conditions](http://www.emerson.com/branson-terms-conditions).

## 1.4 How to Contact Branson

Branson is here to help you. We appreciate your business and are interested in helping you successfully use our products. To contact Branson for help, use the following telephone numbers, or contact the field office nearest you.

- **Brookfield Main Number (all Departments):** (203) 796-0400 (Eastern Time Zone)
- **Parts Store:** Direct Number for Parts Store in Brookfield (203) 796-9807

Tell the operator which product you have and which person or department you need. If after hours, please leave a voice message with your name and return telephone number.

### 1.4.1 Before Calling Branson for Assistance

This manual provides information for troubleshooting and resolving problems that could occur with the equipment (see [Chapter 6: Maintenance](#)). If you still require assistance, Branson Product Support is here to help you. To help identify the problem, use the following questionnaire which lists the common questions you will be asked when you contact the Product Support department.

#### **Before calling, determine the following information:**

1. Your company name and location.
2. Your return telephone number.
3. Have your manual with you.
4. Know your equipment model and serial numbers (found on a gray data label on the units). Information about the Horn (part number, gain, etc.) or other tooling may be etched into the tooling. Software- or firmware-based systems may provide a BIOS or software version number, which may be required.
5. What tooling (horn) and booster are being used?
6. What are the setup parameters and mode?
7. Is your equipment in an automated system? If so, what is supplying the "start" signal?
8. Describe the problem; provide as much detail as possible. For example, is the problem intermittent? How often does it occur? How long before it occurs if you are just powering up? If an error is occurring, which error (give error number or name)?
9. List the steps you have already taken.
10. What is your application, including the materials being processed?
11. Have a list of service or spare parts you have on hand (tips, horns, etc.)
12. Notes: \_\_\_\_\_  
\_\_\_\_\_  
\_\_\_\_\_

## 1.5 Returning Equipment for Repair

NOTICE	
	<p>To return equipment to Branson, you must first obtain an <b>RG</b><b>A number</b> from a Branson Metal Welding representative, or the shipment may be delayed or refused.</p>

If you are returning equipment to Branson for repair, you must first call the Repair department to obtain a Returned Goods Authorization (RGA) number. (If you request it, the repair department will fax a Returned Goods Authorization form to fill out and return with your equipment).

**Branson Metal Welding Repair Department**  
**120 Park Ridge Road**  
**Brookfield, Connecticut 06804 U.S.A.**  
**direct telephone number: (203) 796-0807**  
**fax number: (203) 796-0574**

- Provide as much information as possible that will help identify the need for repair
- Carefully pack the equipment in original packing cartons
- Clearly label all shipping cartons with the RGA number on the outside of cartons as well as on your packing slip, along with the reason for return
- Return general repairs by any convenient method. Send priority repairs by air freight
- You must prepay the transportation charges FOB Brookfield, Connecticut, U.S.A.

### 1.5.1 Get an RGA Number

**RG****A#** \_\_\_\_\_

If you are returning equipment to Branson, please call the Repair Department to obtain a Returned Goods Authorization (RGA) number. (At your request, the Repair Department will fax an RGA form to fill out and return with the equipment).

### 1.5.2 Record information about the Problem

Before sending equipment for repair, record the following information and send a copy of it with the equipment. This will greatly increase Branson’s ability to address the problem.

1. Describe the problem; provide as much detail as possible.  
 For example, is the problem intermittent? How often does it occur? How long before it occurs after powering up?

---



---



---



---

2. Is your equipment in an automated system? NO / YES
3. If the problem is with an external signal, which signal?

---

If known, include plug/pin # (e.g., P29, pin #3) for that signal: \_\_\_\_\_

4. What are the Weld Parameters?

---

---

5. What is your application? (Type of weld, metal material, etc.)

---

6. Name and phone number of the person most familiar with the problem:

---

---

7. Contact the Branson Metal Welding office prior to shipping the equipment.

8. For equipment not covered by warranty, to avoid delay, include a Purchase Order.

*Send a copy of this page with the equipment being returned for repair.*

### **1.5.3 Contact Information**

Call your local Branson Metal Welding Representative, or contact Branson by calling (203) 796-0400.

My Local Branson Representative's name is:

---

I can reach this representative at:

---

## 1.5.4 Pack and Ship the Equipment

1. Carefully pack the system in original packing material to avoid shipping damage. Plainly show the RGA number on the outside of cartons as well as inside the carton along with the reason for return. Make a list of all components packed in the box. **KEEP YOUR MANUAL.**
2. Return general repairs by any convenient method. Send priority repairs by air freight. Prepay the transportation charges FOB the repair site (either the Branson field office or Brookfield, Connecticut USA location).

NOTICE	
	Items that are sent Freight Collect will be refused.

## 1.6 Obtaining Replacement Parts

You can reach the Branson Parts Store at the following telephone numbers:

- Direct Telephone Number: (203) 796-9807
- Fax number: (203) 926-2678

Many parts can be shipped the same day if ordered before 2:30 p.m., Eastern time.

A parts list is found in [Chapter 6: Maintenance](#) of this manual, listing descriptions and EDP part numbers. If you need replacement parts, coordinate the following with your purchasing agent:

- Purchase order number
- 'Ship to' information
- 'Bill to' information
- Shipping instructions (air freight, truck, etc.)
- Any special instructions (for example, "Hold at the airport and call"). Be sure to give a name and phone number
- Contact name information

---

## **Chapter 2: The Branson VersaGraphix Controller**

---

<b>2.1</b>	<b>About this Operating Manual . . . . .</b>	<b>14</b>
<b>2.2</b>	<b>Model Covered . . . . .</b>	<b>15</b>
<b>2.3</b>	<b>Overview of this Model. . . . .</b>	<b>16</b>
<b>2.4</b>	<b>Compatibility with Branson Products. . . . .</b>	<b>17</b>
<b>2.5</b>	<b>Ultrasonic Theory . . . . .</b>	<b>18</b>
<b>2.6</b>	<b>Terminology . . . . .</b>	<b>24</b>

## **2.1 About this Operating Manual**

This manual provides detailed instructions for the setup, operation, and maintenance of the Branson VersaGraphix Controller. For detailed information on operation and maintenance of other components connected to the Controller, refer to appropriate Actuator instruction manual.

The VersaGraphix Controller contains a microprocessor-based controller that provides for control and monitoring of welding operations.

## 2.2 Model Covered

This document is intended for use with a MWX100 actuator. This document is intended for use in conjunction with others to form a complete manual for your Branson Metal Welding system. Please refer to the [Table Of Contents](#) of this Instruction Set to find specific information.

## 2.3 Overview of this Model

The Branson welder generates ultrasonic electrical energy through an ultrasonic converter for welding metals. Several models are available, depending on the desired frequency (for example, 20 kHz) or the desired power range (for example, 2.2 kW). The VersaGraphix also contains a microprocessor-based controller module that provides for control and monitoring of welding operations.

## 2.4 Compatibility with Branson Products

The Branson VersaGraphix Controller is designed to be used with:

- Branson Metal Welding Actuators: MWX100, Ultrasplice 40, Auto Terminator, Ultraweld L20, and Ultraseal 20
- Branson Metal Welding converters: see [Table 2.1 VersaGraphix Controller compatibility with Branson Metal Welding Converters](#) below

**Table 2.1** VersaGraphix Controller compatibility with Branson Metal Welding Converters

Branson Model	Converter
20 kHz/1250 W	503, 105
20 kHz/2500 W	
20 kHz/3300 W	
20 kHz/4000 W	
20 kHz/5000 W	High Power
30 kHz/1500 W	CR-30
40 kHz/400 W	4TJ, 4TR, 4TH
30 kHz/800 W	

## 2.5 Ultrasonic Theory

### 2.5.1 What Is An Ultrasonic Weld?

Ultrasonic welding joins metal parts by applying the energy of high frequency vibrations onto the interface area between the parts to be welded.

#### 2.5.1.1 How Does It Work?

Electrical Energy is transformed into high frequency mechanical vibration. This mechanical vibration is transferred to a welding tip through an acoustically tuned horn. The parts are “scrubbed” together under pressure at 20,000 or 40,000 cycles per second. This high frequency vibration, applied under force, disperses surface films and oxides, creating a clean, controlled, diffusion weld. As the atoms are combined between the parts to be welded, a true, metallurgical bond is produced.

**Figure 2.1** How does Ultrasonic Welding Work?

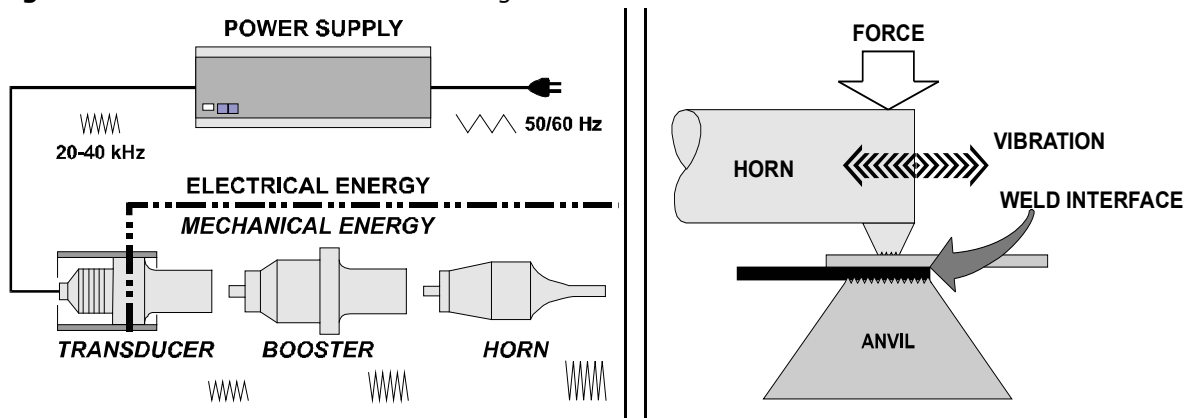

### 2.5.2 Benefits of Ultrasonic Welding

Ultrasonic metal welding exhibits unique welding properties that include:

- Excellent electrical, mechanical, and thermal connections between similar and dissimilar metals
- Low heat build up during the ultrasonic process (no annealing of materials)
- Compensation for normal surface variations of the material
- Ability to clean surface oxides and contaminants prior to welding
- Ability to weld large areas using minimal energy
- Ability to weld thin materials to thick materials
- Low cost per weld

### 2.5.3 How Is An Ultrasonic Weld Made?

Although the theoretical process of producing an ultrasonic weld is uncomplicated, the interactions of the various weld parameters are important and should be understood. When producing an ultrasonic weld, there are three primary variables that interact; they are:

- **Time:** The duration of applied ultrasonic vibration
- **Amplitude:** The longitudinal displacement of the vibration
- **Force:** The compressive force applied perpendicular (normal) to the direction of vibration

The power required to initiate and maintain vibration (motion) during the weld cycle can be defined as:

**Table 2.2** Calculating Power

$$P = F \times A \times f$$

Where:

P = Power (watts)

F = Force \* (N)

A = Amplitude (microns)

f = Frequency (Hertz)

**NOTICE**

Force = (Surface Area of the Cylinder) X (Air Pressure) X (Mechanical Advantage)

Energy is calculated as:

**Table 2.3** Calculating Energy

$$E = P \times T$$

Where:

E = Energy (joules)

P = Power (watts)

T = Time (seconds)

Thus the complete 'Weld To Energy' process would be defined as:

$$E = (F \times A \times f) \times T$$

A well designed ultrasonic metal welding system will compensate for normal variations in the surface conditions of the metals by delivering the specified energy value. This is achieved by allowing Time (T) to adjust to suit the condition of the materials and deliver the desired energy.

#### 2.5.4 Welding To Energy - Why?

Most metal welding applications are produced by 'Welding To Energy' in order to compensate for the various surface oxides and contaminants associated with the metals being joined. In a few applications 'Welding To Time' or 'Welding To Height' will yield better results. Since the majority of all metal welds are produced using energy as the controlling factor we will confine our discussion to that condition.

Welding to energy is necessary because of the non-metallic oxides that form on the metal's surface as well as other contaminants such as grease and dirt. To producing quality welds reliably it is necessary that the surfaces to be joined are clean. The high frequency scrubbing action, combined with pressure, cleans the weld interface at the beginning of the weld process.

The following graph ([Figure 2.2 Weld Power Graph for clean components, dirty components, and when part is missing](#)) illustrates a weld produced. The weld 'power graph' is sometimes referred to as weld 'footprint'. It can be used to visualize the weld cycle and assists in parameter optimization. Graphs from consecutive welds will vary slightly as the system dynamically adjusts time to accommodate varying surface

conditions. The weld power data is gathered by sampling the power used in 5 millisecond intervals.

**Figure 2.2** Weld Power Graph for clean components, dirty components, and when part is missing

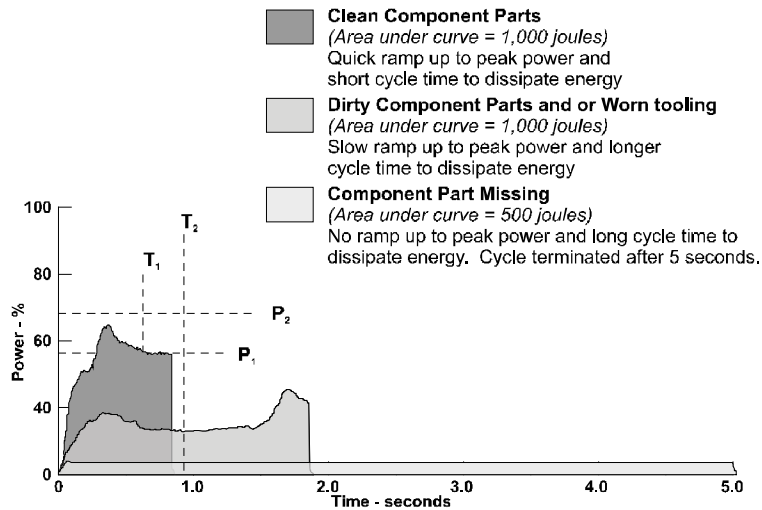

## 2.5.5 Power

The converter/booster/horn, (stack assembly), requires minimal electrical power to initiate and maintain motion (vibration) at a 'no-load' condition. As the mechanical load increases, the power required to maintain the mechanical vibration also increases. The maximum power required during a weld cycle is 'Peak Power'.

By increasing Pressure and maintaining all other parameters, the mechanical load or force on the weld joint increases, therefore, the amount of Power required to maintain the vibration of the stack increases. Subsequently, because of the increased Power Level, less time is required deliver the same amount of Energy. This relationship is illustrated on [Figure 2.3 Pressure Variable with Increased Power](#).

**Figure 2.3** Pressure Variable with Increased Power

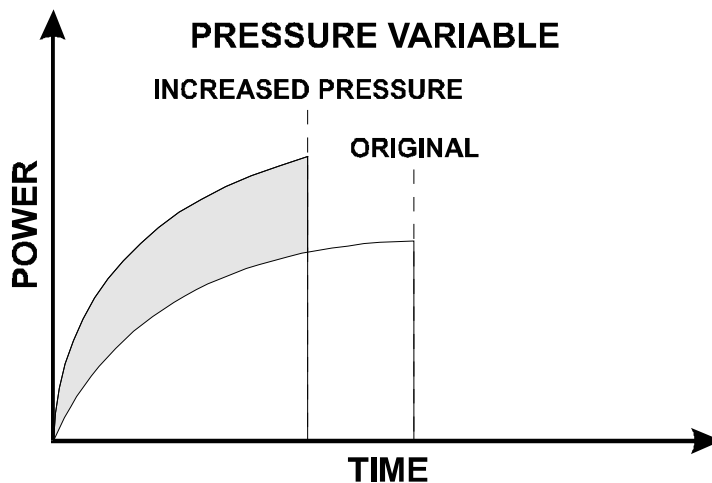

The difference in the appearance of each of the above weld graphs is the result of increased Power loading. Based upon an increase in Pressure, additional Power is required to maintain the motion of vibration. Thus, the same amount of energy is delivered in less time. This approach is typically used to raise the loading of the power supply during a weld cycle to the desired level as determined by the application.

## 2.5.6 Time

The time required to deliver the necessary energy is defined as the Weld Time. For most welds, the time required will be less than one second. If more energy is required and all other weld parameters are maintained, the weld time will increase ([Figure 2.4 Pressure Variable with Increased Time](#)).

**Figure 2.4** Pressure Variable with Increased Time

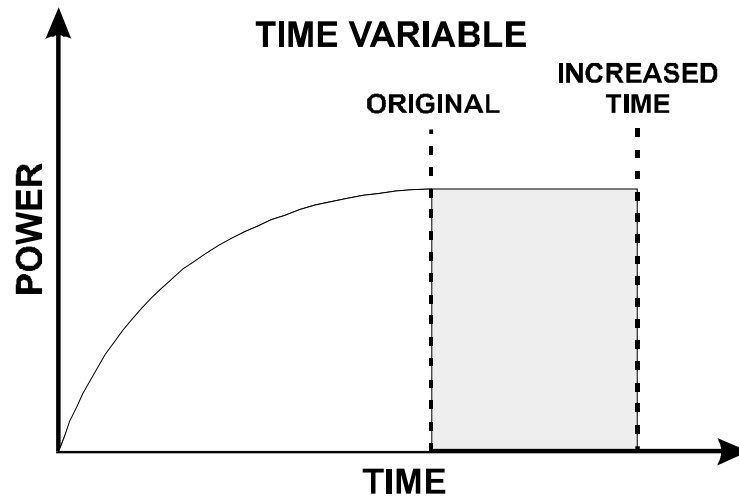

## 2.5.7 Amplitude

An ultrasonic tool is a resonant acoustical device. The term Amplitude is used to describe the amount of longitudinal expansion and contraction that the tooling endures as it vibrates ([Figure 2.5 Scrubbing Action on Weld Interface](#)). The amplitude correlates to the scrubbing action at the weld interface. This scrubbing action combined with pressure is what advances the weld by a diffusing or mixing of the base materials.

**Figure 2.5** Scrubbing Action on Weld Interface

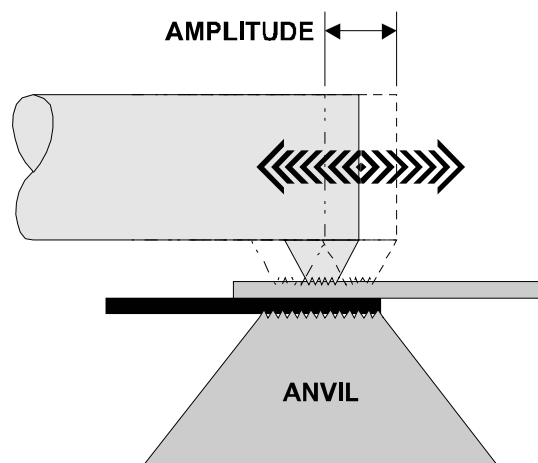

As previously mentioned, the converter/booster/horn, (stack assembly), requires minimal electrical power to initiate and maintain vibration in a 'no-load' condition. As the amplitude increases, the power required to maintain the increased velocity of vibration also increases. Subsequently, because of the increased Power less time is required deliver the same amount of Energy. This relationship is illustrated in the following power diagram ([Figure 2.6 Amplitude's Influence on Weld Power and Time](#)):

**Figure 2.6** Amplitude's Influence on Weld Power and Time

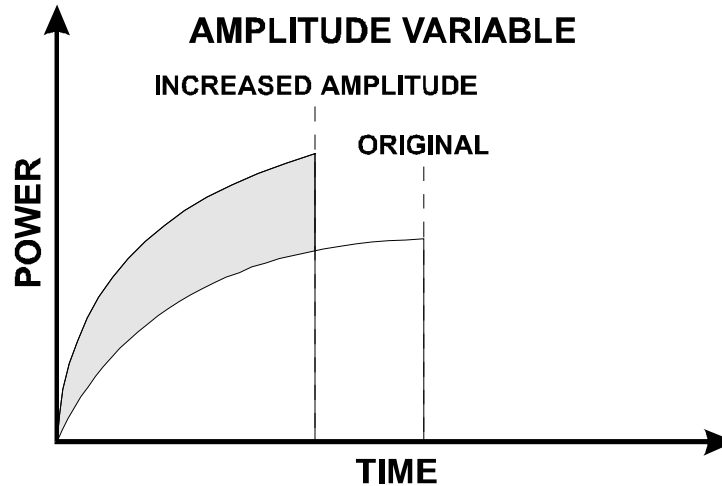

## 2.5.8 Amplitude Stepping

In standard practice, the scrubbing amplitude at the weld interface is maintained constant during a weld cycle. Recent advances in technology have made it possible to change the amplitude of the horn face during the weld cycle. This is known as Amplitude Profiling. [Figure 2.7 Amplitude Stepping Profile](#) illustrates a typical profile where the amplitude is reduced during the cycle. This type of profile is used mostly with welding aluminum to increase weld strength and to help prevent sticking to the tooling.

**Figure 2.7** Amplitude Stepping Profile

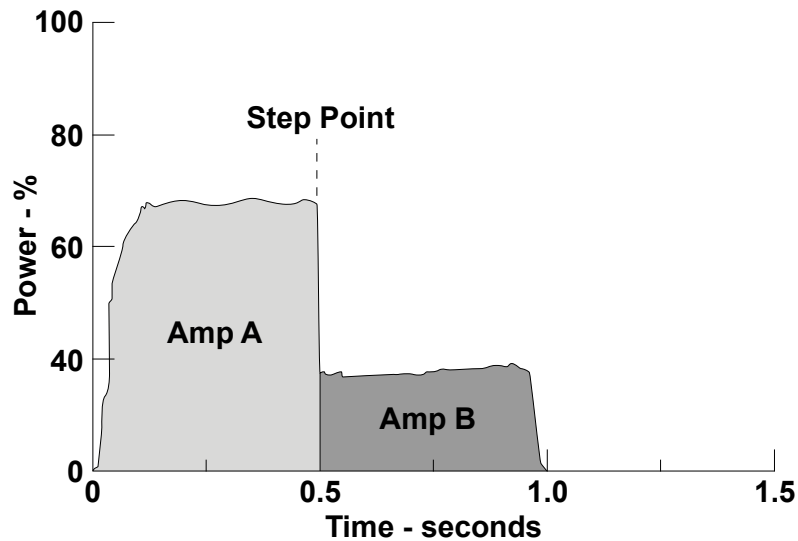

## 2.5.9 Resonant Frequency

The ultrasonic tooling acts as a spring having node points and anti-node points. The mechanical energy used to vibrate the tool is created by the converter. As the vibrations are propagated through the acoustical tool, a harmonic resonance is established consisting of nodes and antinodes. This action results in a resonant wave being transferred through the tooling ([Figure 2.8 Harmonic Resonance on Ultrasonic Tooling](#)). The efficiency of the resonant wave transfer depends on the natural resonant frequency of the horn and is determined by two factors:

- The speed of sound through the material
- The geometric shape of the object

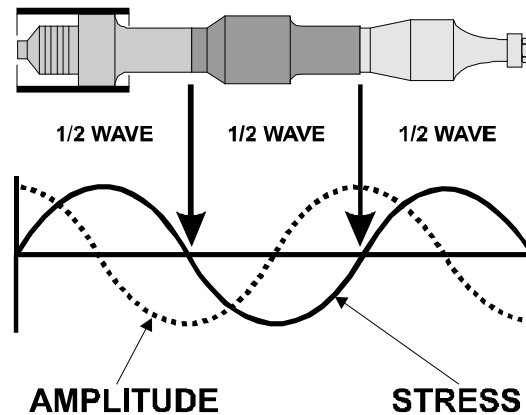
**Figure 2.8** Harmonic Resonance on Ultrasonic Tooling

### 2.5.10 Avoiding An Overload Condition

It is possible to increase the Amplitude and or the Pressure to a point where the power available is not adequate to initiate or maintain vibration under the given mechanical load. At this point, the power supply will stall resulting in an Overload condition. Electronic circuits in the system will protect the power supply if this condition exists.

### 2.5.11 Welding To Time

In specific applications, 'Welding To Time' may be desired. As previously mentioned, there are three primary variables that interact; they are:

- **TIME:** The duration of applied ultrasonic vibration
- **AMPLITUDE:** The longitudinal displacement of the vibration
- **FORCE:** The compressive force applied perpendicular (normal) to the direction of vibration

Generally, welding for a specific time will produce acceptable results when:

- The equipment is installed on an automated production line and each station must complete its process within a certain time limit
- Very small low energy welds on clean components are being made

### 2.5.12 Welding Temperature

Ultrasonic welding produces a localized temperature rise from the combined effects of elastic hysteresis, interfacial slip and plastic deformation. The weld interfaces reach approximately 1/3 the temperatures needed to melt the metals. Since the temperature does not reach the melting point of the material, the physical properties of the welded material are preserved. As the ultrasonic welding process is an exothermic reaction, as welding time increases so does weld temperature.

## 2.6 Terminology

**Actuator:** A mechanical device which houses the converter/booster/horn (stack) assembly in a rigid mounting and is utilized to move the stack up or down. This allows for precise control of welding pressure while delivering mechanical vibrations from the ultrasonic stack to the work piece(s).

**After Burst:** A short duration (burst) of ultrasonic energy that begins after the weld is complete and at 1mm from the final height reading. Used when the splice nugget is sticking to the tooling.

**After Burst Delay:** The amount of time, in seconds, between the completion of the ultrasonic welding cycle and the start of the AFTER BURST. (Also see AFTER BURST).

**Amplitude:** Amplitude is the peak-to-peak displacement of mechanical motion as measured at the face of the horn tip. Amplitude is measured either in thousandths of an inch or in microns (e.g. a standard 40 kHz *Converter* produces approximately .0004" or 10 microns of amplitude), Inches x 25.4 = microns. -- This is adjustable depending on system frequency and application tooling.

**Anti-Node:** The anti-node is the area of the horn and booster that exhibits maximum longitudinal displacement and where the internal dynamic forces are equal to zero. This area is at the face and back surface on half-wave technology.

**Anvil:** A device specially designed to grip the lower component and hold it stationary against the energy of vibration(s) which allows a weld to be created.

**BBR:** Nonvolatile random access memory (battery back-up random access memory). Equipped with long life built in batteries, this memory area preserves weld parameters and menu settings when the system is powered off. (Also known as BRAM).

**Booster:** The central component of an ultrasonic stack assembly. A device which transfers mechanical energy from the *Converter* to the ultrasonic horn. The booster will, depending on design, increase, decrease, or maintain the specific amplitude as received from the converter.

**Calibration:** The process of adjusting a device to a known position for purposes of inspection and/or monitoring position, direction, speed, and/or velocity.

**Consumable Spare Tooling:** The tooling portion of the ultrasonic system that wears and requires replacement due to production use. This includes but is not limited to ultrasonic horns, replaceable tips, anvil, and positioning mask. A Spare Tooling Specification Sheet is included within the Actuator Operation Manual to document the spare tooling for a specific metal welding application.

**Controller:** The portion of the welding system that provides specific settings & instruction(s) to the overall welding system.

**Converter:** A device which utilizes a PZT (lead-zirconate-titanate) electrostrictive element to change high frequency electrical energy into high frequency mechanical energy.

**Counter:** A programmable device used to monitor system cycles and alert personnel when specific conditions are met.

**Data:** Any representation(s) of instructions, characters, information, or analog quantities to which meaning may be assigned.

**Default:** A chosen system setting or parameter in which the system does not require external data input. In some cases the default value will be changed based upon equipment use.

**Dynamic Spring:** An, adjustable, energy storage mechanism (shock absorber) which allows for stack follow through upon engagement of application tooling with the work pieces to be welded.

**Energy:** Energy is the area beneath the ultrasonic power curve and is calculated in joules, (Watts X Seconds = Joules). When the ultrasonic welding system is setup in the "Weld In Energy" mode the system will deliver the amount of energy as programmed. **NOTE:** The maximum (default) time allowed for delivering ultrasonic energy is five (5) seconds.

**Energy Mode:** A welding method in which the ultrasonic power supply is active until the required amount of energy is delivered (see ENERGY).

**Fixture:** A device for positioning and or holding a component for assembly.

**Force:** The amount of mechanical pressure that is used to deliver (bring down) the mechanical actuator. This programmed force is also called TRIGGER FORCE and is used to engage the knurl pattern into the component part(s) prior to the initiation of ultrasonic energy.

**Frequency:** The number of complete oscillations per second expressed in Hertz (Hz) or kilohertz (1 kilohertz = 1000 Hz). Typically 20 kHz or 40 kHz.

**Gain:** The ratio of the amplitude of motion produced by the *Converter* and delivered by the horn is called the gain. It is determined by the difference in mass on either side of the nodal point.

**Height:** A value, in millimeters (mm), as registered by a linear encoder upon completion of an ultrasonic welding cycle. -- Programmable, in millimeters, with Upper Control Limit & Lower Control Limit.

**Height Encoder:** A device utilized to monitor position, direction, speed, and/or velocity.

**Horn:** An acoustically designed metal tool that delivers mechanical energy from the converter/ booster into the work piece. Most applications utilize half wave technology.

**Hold Time:** The amount of time after delivery of ultrasonic energy until the stack tooling begins to retract from the component material(s).

**Joint:** The area where the surfaces are welded together.

**Linear Height Encoder:** See Height Encoder.

**Loading Meter:** A meter which indicates the power drawn from the ultrasonic power supply.

**Maintenance Counter:** Used to alert production personnel of the need to review/ inspect application tooling and/or the ultrasonic system for preventive maintenance purposes. (See Counters).

**Mode:** The method of operating the system (also see WELDING MODE).

**Node:** The node is the area of the horn, (and booster), that exhibits no longitudinal displacement and where the internal dynamic forces are at the maximum. This area is in the center location on half-wave technology.

**Parameter(s):** Programmable units used to control and or monitor the ultrasonic process. --Include but not limited to ENERGY, FORCE, PRESSURE, AMPLITUDE.

**Parts Counter:** Used to monitor system cycles and alert personnel when specific conditions are met. (See Counters).

**Peak Power:** Peak power is the maximum amount of power in watts that was required to keep the ultrasonic stack in motion during the weld cycle.

**Power:** Power, measured in watts, is a function of pressure and amplitude. The amount of power, (watts) required to keep the ultrasonic stack in motion is monitored and used to develop a power curve. This power curve is used to calculate the amount of energy delivered/ dissipated, (Watts = Joules / Time). The power as displayed on the control box is peak power.

**Power Supply (Ultrasonic):** An electronic device that converts 50/60 cycle electrical current into 40 kHz, (40,000) or 20 kHz, (20,000) cycles per second high frequency electrical energy.

**Power Supply Overload (Ultrasonic):** The point or limit at which the amount of power in watts, required to keep the ultrasonic stack in motion, exceeds the available power from the power supply. The system will go into an overload condition in order to prevent system damage.

**Pre-Burst:** A short duration (burst) of ultrasonic energy that begins after the Squeeze Time and before capturing the Pre-Height. Used when welding magnet wire. It helps to break up the insulation around the copper, and provide a small cooling period before the weld takes place.

**Pre-height:** A pre-sonic inspection display, in millimeters (mm), as registered by a linear encoder prior to initiation of the ultrasonic welding cycle. -- Programmable, in millimeters, with Upper Control Limit & Lower Control Limit.

**Presets:** Welding parameters stored in the controller memory.

**Pressure:** The amount of mechanical pressure supplied to the ultrasonic stack assembly while delivering ultrasonic energy to the components.

**Quality Widows & Limits:** Programmable values used by the system to compare actual process data. Actual process data must be within limits or an alarm be issued.

**Quick After Burst:** Once this option is enabled, the after burst needs to be implemented immediately after each weld cycle finished without any time delay or condition judgment.

**Squeeze Time:** The amount of time after the ultrasonic tooling engages the component (s) and before delivery of ultrasonic energy. -- Adjustable from 0 - 2 seconds.

**Stress:** Stress is the amount of dynamic force per cross sectional area.

**Time:** Time is the duration of the ultrasonic, mechanical, activity. Time is a component used to calculate the amount of ultrasonic energy delivered during a weld cycle, (Time = Joules / Watts).

**Tip:** Device specially designed to grip the upper component, to be welded, and to direct the ultrasonic energy into the work piece, (Also Horn Tip & Replaceable Horn Tip).

**Tip Nut:** Device specially designed to securely clamp a replaceable tip onto the horn.

**Trigger Force:** See Force.

**Tuning:** Adjusting to optimize power supply performance according to resonance frequency, especially with regard to the horn and converter.

**Velocity:** The rate of motion at a specific time [velocity = distance time] Also referred to as speed.

---

## **Chapter 3: Shipping and Handling**

---

<b>3.1</b>	<b>Shipping and Handling</b> .....	<b>28</b>
<b>3.2</b>	<b>Receiving</b> .....	<b>29</b>
<b>3.3</b>	<b>Unpacking</b> .....	<b>30</b>
<b>3.4</b>	<b>Returning Equipment</b> .....	<b>31</b>

## 3.1 Shipping and Handling

CAUTION	
	<p>The VersaGraphix Controller's internal components are sensitive to static discharge. Many components can be harmed if the unit is dropped, shipped under improper conditions or otherwise mishandled.</p>

### 3.1.1 Environmental Specifications

The VersaGraphix Controller is an electronic unit that converts line voltage to ultrasonic energy and controls user input for regulating the weld process. Its internal components are sensitive to static discharge, and many of its components can be harmed if the unit is dropped, shipped under improper conditions, or otherwise mishandled.

The following environmental guidelines should be respected when shipping the VersaGraphix Controller and Touchscreen Monitor:

**Table 3.1** Environmental Requirements for Shipping

Environmental	Range
Storage / Shipping Temperature	-13° F to +131° F (-25° C to +55° C)
Shock / Vibration (Transit)	40 g shock / 0.5 g and (3-100 Hz) vibration per ASTM 3332-88 and 3580-90
Humidity	30% to 95%* non condensing

\*Above 40° C the humidity drops to 90%

## 3.2 Receiving

The VersaGraphix Controller is a sensitive electronic device. Many of its components can be harmed if the unit is dropped or otherwise mishandled.

CAUTION	
	<p>The Actuator and the VersaGraphix Controller are heavy. Handling, unpacking, and installation might require assistance or the use of a lifting device.</p>

### 3.2.1 Scope of Delivery

Branson units are carefully checked and packed before dispatch. It is recommended, however, that you follow the inspection procedure below after delivery.

### 3.2.2 To inspect the VersaGraphix Controller when it is delivered

**Table 3.2** Inspect the VersaGraphix Controller upon delivery

Step	Action
1	Verify that all parts are complete according to the packing slip.
2	Check the packing and the unit for damage (visual inspection).
3	Report any damage claims to your carrier immediately.
4	Determine if any component has become loose during shipping and, if necessary, tighten screws.

NOTICE	
	<p>If the goods delivered have been damaged during shipping, please contact the forwarding agent immediately. Retain packing material (for possible inspection or for sending back the unit).</p>

CAUTION	
	<p>The Actuator and the VersaGraphix Controller are heavy. Handling, unpacking, and installation might require assistance or the use of a lifting device.</p>

## 3.3 Unpacking

The VersaGraphix is fully assembled. It is shipped in a sturdy cardboard box. Some additional items are shipped in the box with the Controller.

**Table 3.3** When unpacking the Controller, take the following steps

Step	Action
1	Unpack the VersaGraphix Controller as soon as it arrives. Save the packing material.
2	Inspect the unit for signs of damage.
3	Remove the cover of the VersaGraphix Controller (see section <a href="#">6.4 Parts Replacement</a> ) to check if any components became loose during shipping.
4	Store or ship the VersaGraphix Controller only within a temperature range of -13° F to +131° F (-25° C to +55° C).

NOTICE	
	<p>If damage has occurred, notify the shipping company immediately. Retain packing materials for inspection.</p>

### **3.4 Returning Equipment**

If you are returning equipment to Branson, please call your Branson Metal Welding Representative or Customer Service to receive approval to return goods to Branson.

If you are returning equipment for repair refer to [Chapter 1: Safety and Support](#), section [1.5 Returning Equipment for Repair](#) of this manual, for appropriate procedure.



---

## **Chapter 4: Technical Specifications**

---

<b>4.1</b>	<b>Environmental Requirements . . . . .</b>	<b>34</b>
<b>4.2</b>	<b>Electrical Requirements . . . . .</b>	<b>35</b>
<b>4.3</b>	<b>Pneumatic Requirements . . . . .</b>	<b>36</b>
<b>4.4</b>	<b>Operating System . . . . .</b>	<b>37</b>

## 4.1 Environmental Requirements

The VersaGraphix Controller and Touchscreen Monitor have the following Environmental Requirements:

**Table 4.1** Environmental Requirements

Environmental Concern	Controller/VersaGraphix Controller	Touchscreen
Ambient Operating Temperature	+41° F to +122° F (+5° C to +50° C)	+32° F to +104° F (0° C to +40° C)
Storage / Shipping Temperature	-13° F to +131° F (-25° C to +55° C*)	-4° F to +131° F (-20° C to +55° C)
Humidity	Maximum 95%, non condensing	30% to 80%
IP Rating	2X	

\*70° C for 24 hours.

## 4.2 Electrical Requirements

The following tables list input voltages, current requirements, and fuse requirements for the VersaGraphix Welding System, and includes power required when it is used with Branson Metal Welding Actuators.

**Table 4.2** Electrical Input Operating Voltages

<b>VersaGraphix Controller Ratings</b>	<b>Nominal Input Operating Voltage +/- 10%</b>
30 kHz / 1500 W	200 - 230 V, 50/60 Hz, Single Phase
40 kHz / 800W	100 - 120, 200 - 230 V, 50/60 Hz, Single Phase

**Table 4.3** Input Current and Fuse Requirements

<b>Model</b>	<b>Power</b>	<b>Current Rating</b>
For 30 kHz Models	1500 W 200 - 230 V	10 amp max. @ 200 V / 10 amp fuse
For 40 kHz Models	800 W 200V - 230 V	5 amp max. @ 200 V / 20 amp fuse
	800 W 100V - 115 V	10 amp max. @ 100 V / 20 amp fuse

## 4.3 Pneumatic Requirements

The factory compressed air supply must be “clean (to a 5 micron level), dry and unlubricated” air with a regulated maximum pressure of 80 psig (5.5 bar).

## 4.4 Operating System

The VersaGraphix Controller uses an embedded Single Board Computer (SBC) to offer advanced user interface functions. It uses Windows 10 IoT Enterprise LTSC as its operating system.

### 4.4.1 About Microsoft Windows 10 IoT Enterprise LTSC

While Windows 10 IoT Enterprise LTSC is similar to the standard desktop version of Windows 10 there are some differences that the advanced user should be aware of.

To protect the application and the operating system, Windows employs a Unified Write Filter Utility (UWF). This filter uses a RAM overlay to record changes to the Solid State Drive. Any changes made to the C: drive are lost during a power cycle. Only the C:\AmtData folder remains unprotected allowing the VersaGraphix application to write directly to the C: drive in order to save presets, sequences, setup parameters and log files.

The UWF must be disabled before modifying the Windows configuration. Changes made to Windows configuration such as printer driver installation or Local Area Network configuration will be lost if the UWF has not been previously disabled. Once all changes have been saved, the UWF must be re-enabled before resuming controller operations. Enabling and disabling the UWF goes beyond the scope of this application user manual. Contact customer support if this becomes necessary (see section [1.5.3 Contact Information](#)).

NOTICE	
	Operating the system while the UWF is disabled will not allow the application to save presets, sequences, setup parameters and log file information.



---

## Chapter 5: Operation

---

<b>5.1</b>	<b>Before You Begin</b> . . . . .	<b>40</b>
<b>5.2</b>	<b>Pop Up Alphanumeric Keypad</b> . . . . .	<b>41</b>
<b>5.3</b>	<b>Pop Up Numeric Keypad</b> . . . . .	<b>42</b>
<b>5.4</b>	<b>Editing Buttons</b> . . . . .	<b>43</b>
<b>5.5</b>	<b>Pull Down Menus</b> . . . . .	<b>44</b>
<b>5.6</b>	<b>Create New Preset</b> . . . . .	<b>48</b>
<b>5.7</b>	<b>Create New Sequence</b> . . . . .	<b>50</b>
<b>5.8</b>	<b>Edit Sequence</b> . . . . .	<b>52</b>
<b>5.9</b>	<b>File Manager</b> . . . . .	<b>54</b>
<b>5.10</b>	<b>Run Menu</b> . . . . .	<b>57</b>
<b>5.11</b>	<b>Options Menu</b> . . . . .	<b>68</b>
<b>5.12</b>	<b>Remote Data Collection</b> . . . . .	<b>75</b>
<b>5.13</b>	<b>View Menu</b> . . . . .	<b>79</b>
<b>5.14</b>	<b>Help Menu</b> . . . . .	<b>83</b>
<b>5.15</b>	<b>Language Support</b> . . . . .	<b>84</b>

## 5.1 Before You Begin

WARNING	
	<p><b>High voltage</b> might be present in the Branson VersaGraphix Controller (VersaGraphix). When setting up and operating the welding system, observe the potential hazards listed below.</p>

- Do not operate the VersaGraphix with the cover removed
- To prevent the possibility of electric shock, always plug the VersaGraphix Controller into a grounded power source
- Do not cycle the welding system if either the RF cable or the converter is disconnected. High voltage could be present at open power connections
- Ensure power switch is in the OFF position before making or breaking any electrical or pneumatic connections to the VersaGraphix and/or Welder
- Do not touch Ultrasonic Horn during or immediately following the welding cycle. Vibrations and heat can burn skin

## 5.2 Pop Up Alphanumeric Keypad

**Figure 5.1** Pop up Alphanumeric Keypad

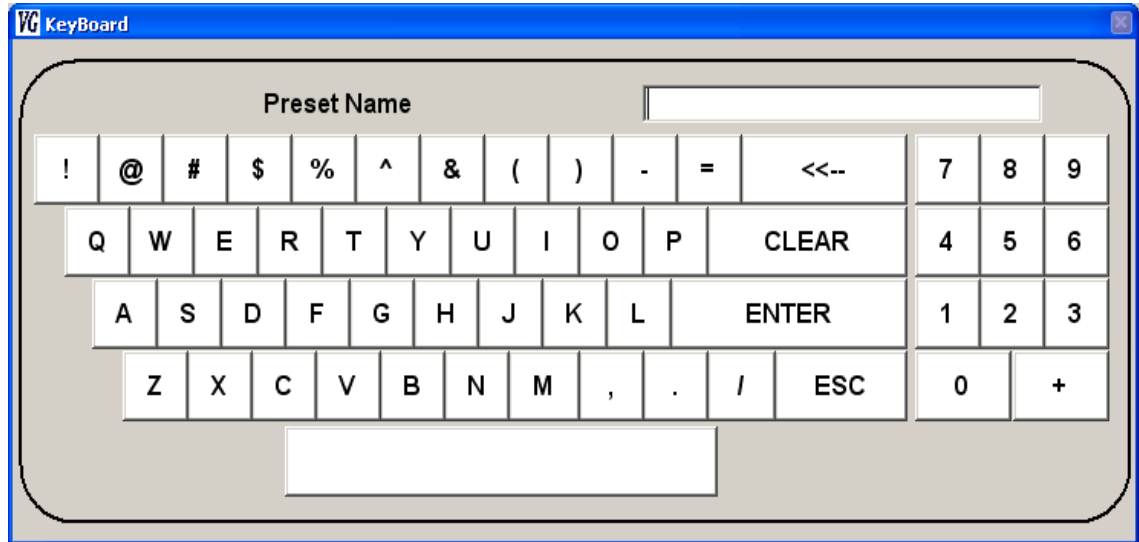

A pop up keypad will be displayed on the touchscreen when it is necessary to enter alphanumeric data using the touchscreen. This keyboard includes upper case letters A through Z, numbers 0 through 9, space, backspace, enter, clear and cancel. It also includes the following symbols: ! @ # \$% ^ & ( ) - = / + and , .

Using non permitted characters when naming a preset or a sequence may happen if you use an external keyboard. To avoid system errors due to invalid name, please refer to the alphanumeric characters in the image above when naming a preset or a sequence with an external keyboard.

## 5.3 Pop Up Numeric Keypad

Figure 5.2 Pop up Numeric Keypad

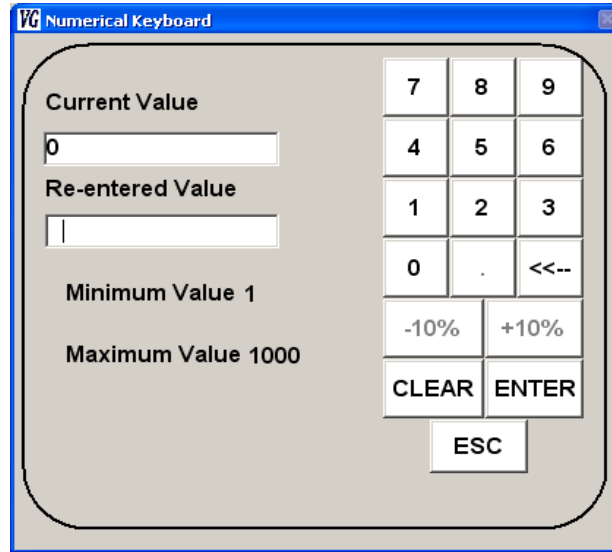

A numeric keypad will pop up on the touchscreen when it is necessary to input numeric data. This Keypad includes buttons for the numbers 0 through 9, decimal point, Backspace (<<--), ENTER, CLEAR, and ESC. It also has a +10% button and a -10% button, which are used to enter values +/- 10% of the currently set value, allowing quicker setups.

## 5.4 Editing Buttons



### Edit

When the "Edit" is highlighted, it allows you to edit sequences.



### Delete

When the "Delete" button is highlighted, you may remove unwanted sequence steps. On the file manager screen the "Delete" buttons allows you to eliminate unwanted files in the Browse and Application folders.



### Enter

Touching the "Enter" button saves changes.



### Copy

When highlighted, the "Copy" button allows you to create a copy of a sequence step.



### Escape

Touching the "Escape" button undoes the previous change.



### Copy To

"Copy To" buttons are available on the File Manager screen. You may use them to copy files between the Browse and Application folders.



### Move To

"Move To" buttons are available on the File Manager screen. You may use them to move files between the Browse and Application folders.



### Select All

"Select All" buttons are available on the File Manager screen. You may use them to **Move, Copy, or Delete** at once all files in the user's or Branson's Application folders.

## 5.5 Pull Down Menus

Use the pull down menus at the top of each screen to navigate between different screens. The title of each screen appears in the screen's title bar.

### 5.5.1 File Menu

Figure 5.3 File Menu

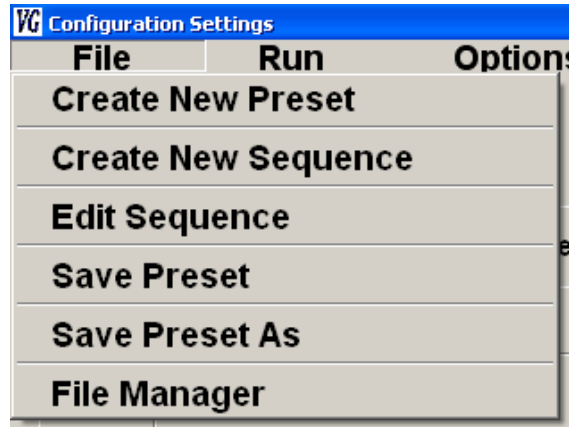

#### 5.5.1.1 Create New Preset

Select Create New Preset to input new weld Preset names into the controller. The Presets will be saved into the controller's library with default preset values. You may then proceed to the Setup screen to enter the preset's weld parameters. See [5.10.3 Setup Screen \(When Running a Preset\)](#) for more information on entering weld parameters.

#### 5.5.1.2 Create New Sequence

Select Create New Sequence to input weld sequences. A sequence is a series of grouped weld presets which are to be executed in a particular quantity and order. Sequences are constructed using existing weld presets stored in the Controller's library.

#### 5.5.1.3 Edit Sequence

Touching this option will take you to the Edit Sequence screen where you can modify Sequences.

#### 5.5.1.4 Save Preset

When a preset is modified on the Setup Screen, the preset is modified in running memory. An ' \* ' symbol is appended to the preset name to indicate that the preset has not been saved. By selecting Save Preset, changes to the preset that is currently running on the Controller are made permanent. This also causes the ' \* ' to disappear from the preset name.

NOTICE	
	<p>Unless the preset is saved by selecting Save Preset, all unsaved setup changes will be lost when loading a different preset, closing the VersaGraphix application, or powering off the VersaGraphix Controller.</p>

### 5.5.1.5 Save Preset As

By selecting Save Preset as you can create a copy of the preset currently running on the Controller. You will be prompted to supply a new preset name. This new preset will be automatically loaded to memory.

### 5.5.1.6 File Manager

Selecting File Manager will take you to the Branson File Manager screen. From this screen files can be moved and copied between your directories and Branson's Application Directory. You can also delete files from either your own folders or from Branson's application folders.

## 5.5.2 Run Menu

**Figure 5.4** Run Menu

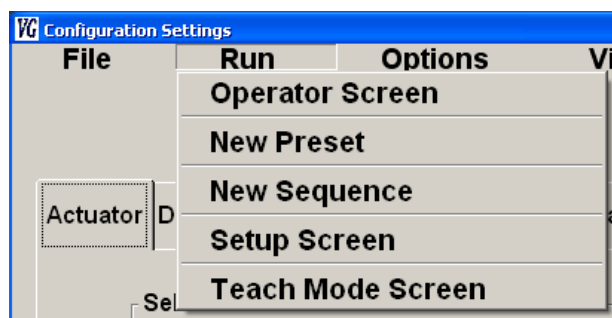

### 5.5.2.1 Operator Screen

Touching this button will take you to the operator screen. You can choose the Operator Screen to be the start screen when you turn on your controller. For information see [5.11.1.5 System Configuration](#).

### 5.5.2.2 New Preset

Select New Preset to load a preset from the Controller's library. After selecting a preset the Operator Screen will be displayed.

### 5.5.2.3 New Sequence

Select New Sequence is used to load a Sequence from the Controller's library. After selecting a sequence the Operator Screen will be displayed.

### 5.5.2.4 Setup Screen

When running a preset, select Setup Screen to change individual weld parameters which are the basic elements required to make a weld. See [5.10.3 Setup Screen \(When Running a Preset\)](#) for more details on entering weld parameters.

When running a Sequence, the Setup Screen can be used to monitor results for each weld. Weld parameters cannot be edited when running a sequence.

You can choose the Setup Screen to be the start screen when you turn on your controller. For information see [5.11.1.5 System Configuration](#).

## 5.5.3 Options Menu

Figure 5.5 Options Menu

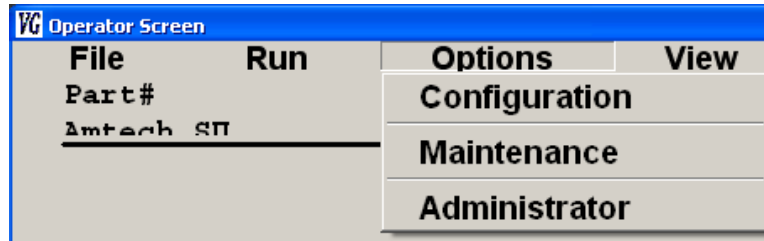

### 5.5.3.1 Configuration

Select this option to access the Configuration screen where Controller features can be setup. These features include: Actuator model; default weld settings; Teach Mode settings; System Configuration; and COM settings.

### 5.5.3.2 Maintenance

Select this option to access the Maintenance screen. This screen allows adjustment and on-demand control of motion devices used in the actuator. This screen also allows access to the maintenance log, maintenance counters, and limit settings.

### 5.5.3.3 Administrator

Select this option to access the Administrator screen. From this screen you can exit the Controller program; determine if Windows should shut down at exit; rename auxiliary buttons; enable password requirement; edit the Administrator and Technician passwords; and set screen permissions.

NOTICE	
	The default password is <b>ADMIN</b> .

## 5.5.4 View Menu

Figure 5.6 View Menu

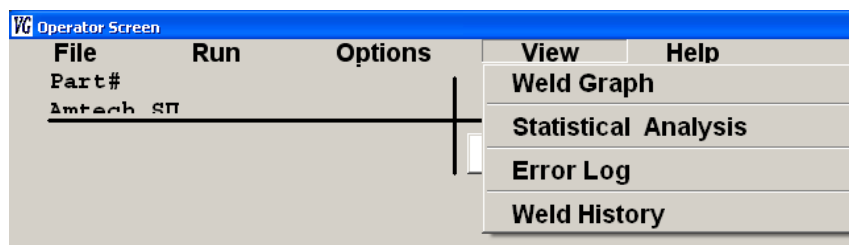

### 5.5.4.1 Weld Graph

Selecting this option will display a popup window with a graph showing how the last weld developed over time.

#### 5.5.4.2 Statistical Analysis

Select this option to view weld result data for Time, Power, Pre-Height and Height in relation to their quality windows.

#### 5.5.4.3 Error Log

Selecting this option will take you to the Error Log window. In this window the date/time, part name, error type and value for unsuccessful welds can be viewed and printed.

#### 5.5.4.4 Part History

Select this option to view and/or print weld results.

### 5.5.5 Help Menu

Figure 5.7 Help Menu

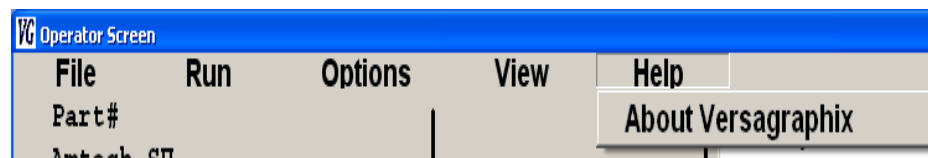

#### 5.5.5.1 About VersaGraphix

Select About VersaGraphix to display the VersaGraphix's software version, and Controller version.

### 5.5.6 Branson Logo

Figure 5.8 Branson Logo



Touching the Branson logo in any of the screens will cause the Language Settings window to pop up.

## 5.6 Create New Preset

**Table 5.1** Steps to create a new Preset

Step	Action
1	Select Create New Preset from the File Menu.

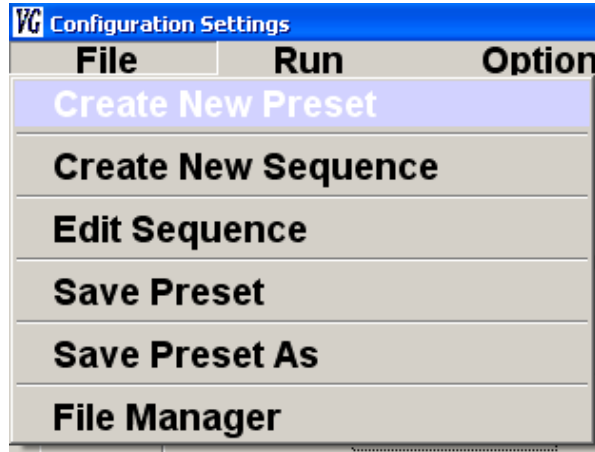

Step	Action
2	Touch the field next to Preset Name (An alphanumeric keyboard will pop up). Input the preset name (20 characters max).

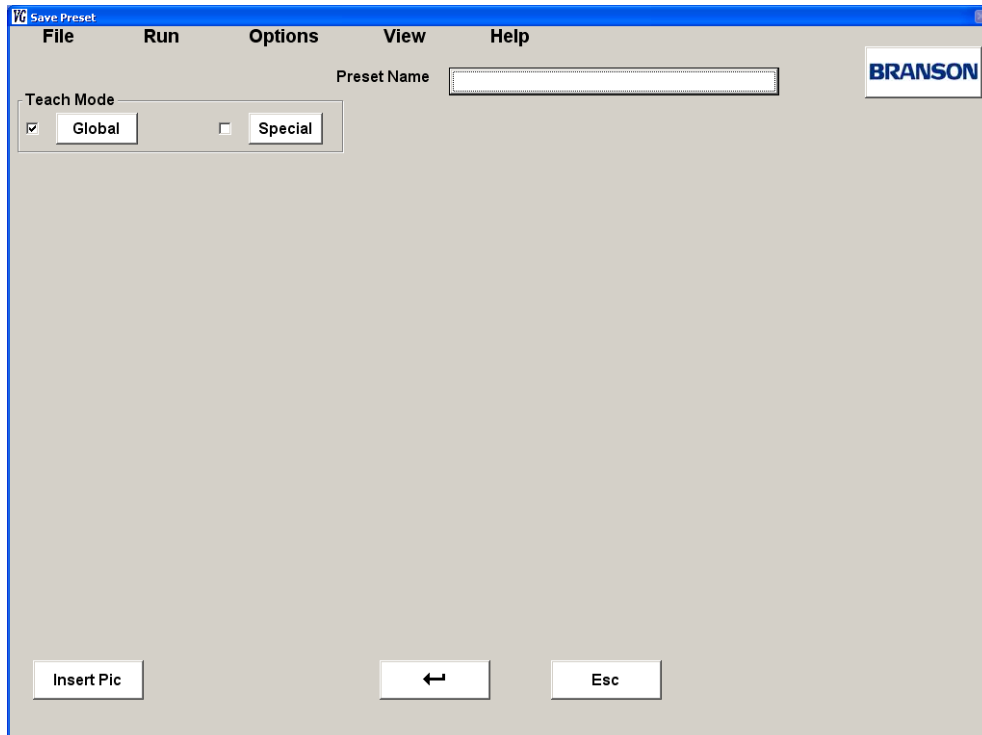

Step	Action
3	Select either Global or Special Teach Mode settings for your preset. Global Settings are set on the Teach tab in the Configuration Screen. For more information, see <a href="#">5.11.1.3 Teach Mode Settings</a> .
4	Touch the Insert Pic button to include an image to be displayed on the Operator screen as a visual aid for manufacturing.
5	Press the Enter button to save the preset.

Presets will be saved into the controller's library with default preset values. You may then proceed to the Setup screen to enter the preset's weld parameters. See [5.10.3 Setup Screen \(When Running a Preset\)](#) for more information on entering weld parameters.

## 5.7 Create New Sequence

**Table 5.2** Steps to create a new Sequence

Step	Action
1	From the File menu select <b>Create New Sequence</b> .

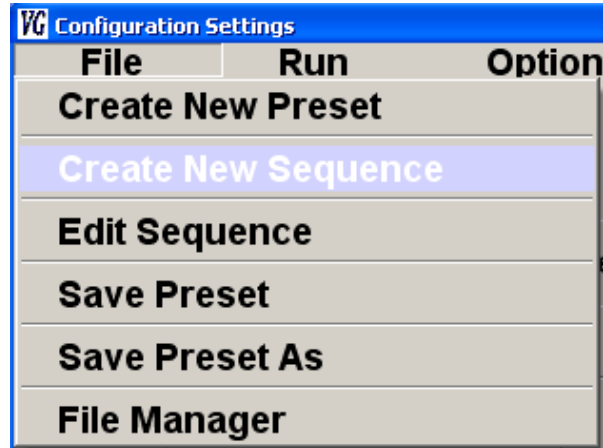

Step	Action
2	Touch the field next to <b>Sequence Name</b> . (An alphanumeric keyboard will pop up). Input the sequence name (20 characters max).

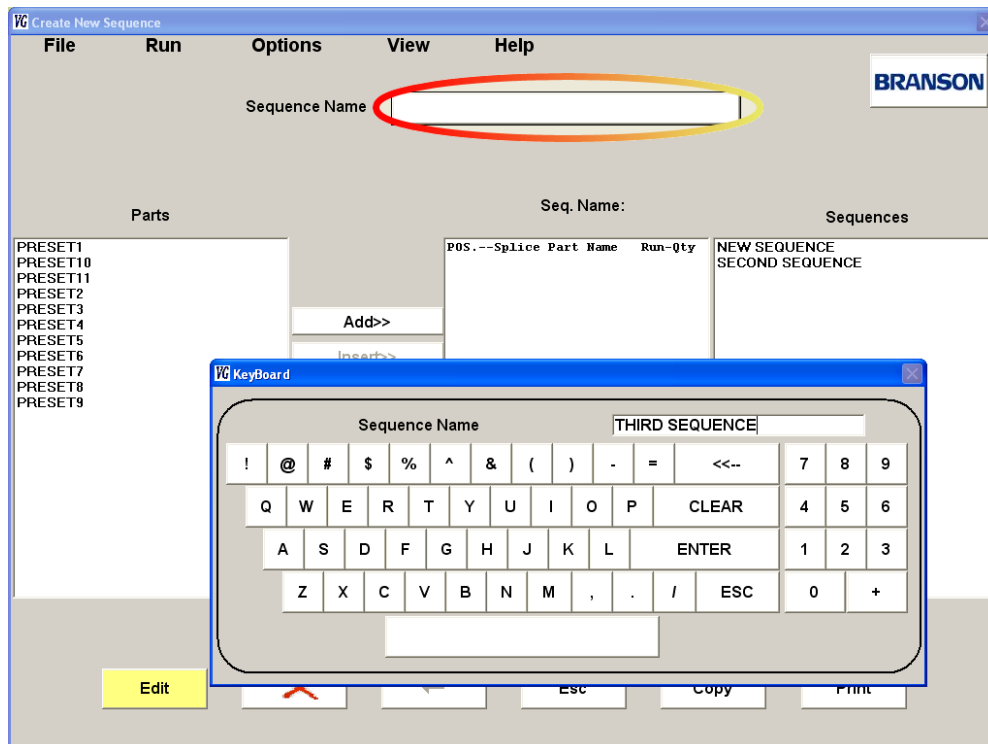

Step	Action
3	Touch the <b>ADD&gt;&gt;</b> button then choose a Preset from the Parts list to add a step. A numerical keyboard will pop up. Enter the number of welds for the step. Each step in a sequence can support multiple welds of a single weld preset.

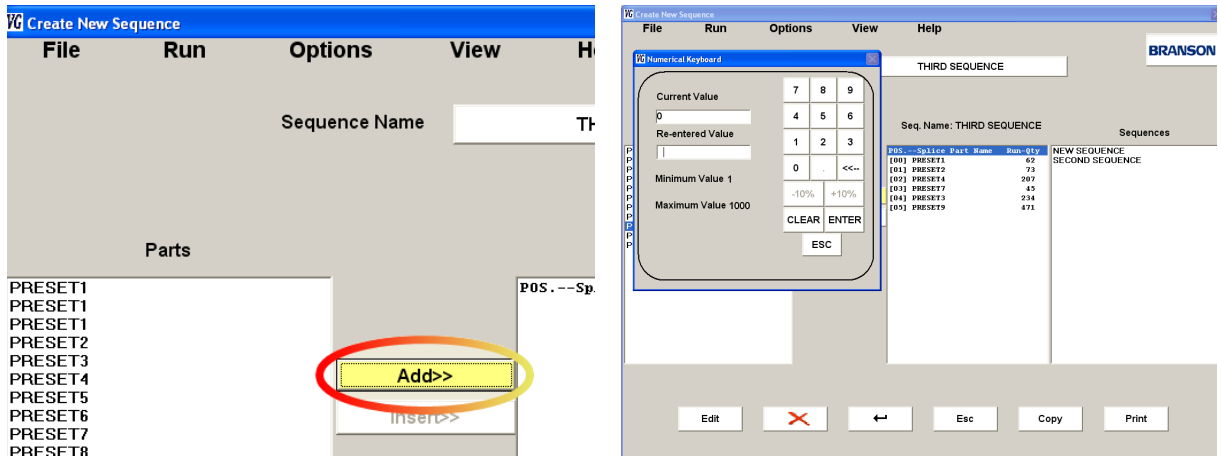

Step	Action
4	Touching the <b>Insert&gt;&gt;</b> button allows user to insert steps. After touching the Insert button select a part from the Parts list. Then touch the position above which you wish to insert it. A numeric key pad will pop up. Enter the amount of welds you wish to make and press enter to insert the step.

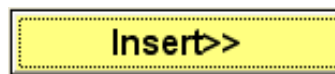

Step	Action
5	Once sequence has been completed touch the <b>Enter</b> button to save it. The VersaGraphix supports up to 250 presets per sequence.

## 5.8 Edit Sequence

Existing Sequence presets may be edited from the Edit Sequence Screen.

**Table 5.3** Steps to edit existing presets from the Edit Sequence Screen

Step	Action
1	From the File menu touch the Edit Sequence.

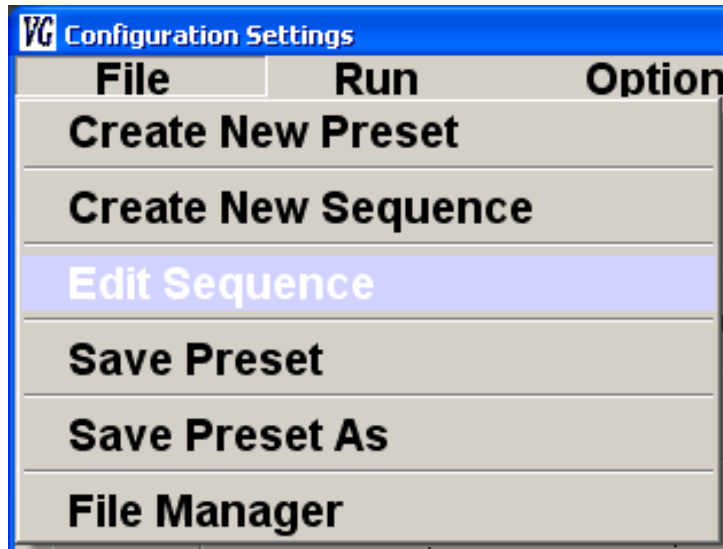

Step	Action
2	Touch the <b>Edit</b> button so that it is highlighted. Select the <b>Sequence</b> preset to be edited from the preset library.

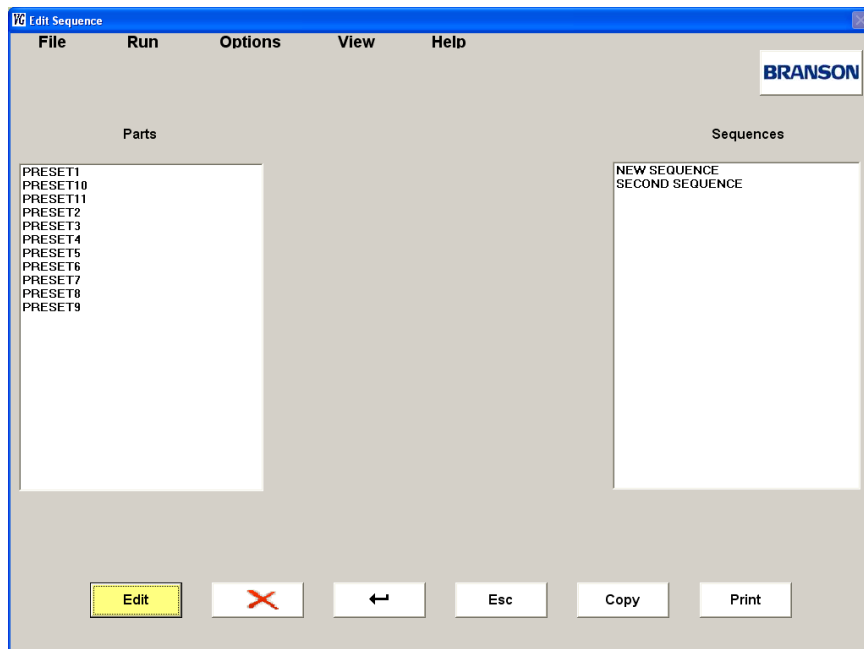

Step	Action
3	A list box with the sequence's steps will appear in the middle of the window. The steps may now be edited (go to <a href="#">5.7 Create New Sequence</a> for more information on sequences).
4	Press the enter button to save the changes.

## 5.9 File Manager

**Figure 5.9** VersaGraphix File Manager Screen

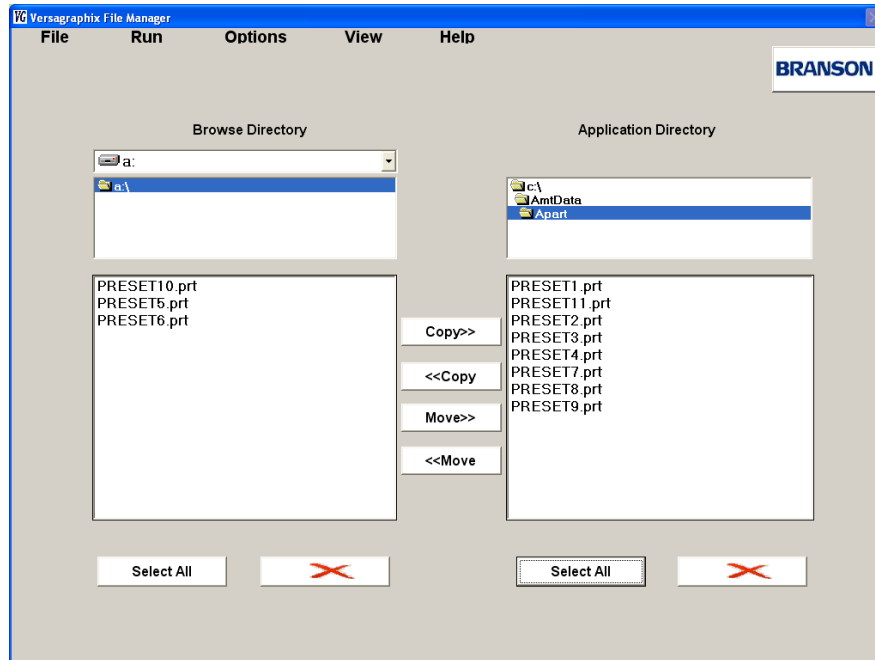

The File Manager screen is used to maintain data files used by the application. You may copy Presets, Sequences and History files to and from the VersaGraphix to other storage devices such as USB memory sticks, and external network drives. The Application Directory box shows the files that are available to the application. They are stored in a fixed directory structure as shown. The user's browsing on the controller files is limited to these three directories:

Presets: C:\AmtData\Apart\Prstname.prt

Sequences: C:\AmtData\Aseq\Seqname.seq

Log Files: C:\AmtData\history\Wename.tsv

### 5.9.1 Copying Files To The Application

**Table 5.4** To copy files from the **Application Directory** to the **Browse Directory**

Step	Action
1	Touch the <b>&lt;&lt;Copy</b> button, so that it is highlighted.
2	Touch the file(s) on the <b>Application Directory</b> that you wish to copy into the <b>Browse Directory</b> .

**Table 5.5** To copy files from the **Browse Directory** to the **Application Directory**

Step	Action
1	Touch the <b>Copy&gt;&gt;</b> button, so that it is highlighted.

**Table 5.5** To copy files from the **Browse Directory** to the **Application Directory**

Step	Action
2	Touch the file(s) on the <b>Browse Directory</b> that you wish to copy into the <b>Application Directory</b> .

NOTICE	
	Only files of types .prt, .seq, and .tsv can be copied using the file manager. They will automatically be put into the appropriate application library directory.

## 5.9.2 Moving Files

**Table 5.6** To move files from the **Application Directory** to the **Browse Directory**

Step	Action
1	Touch the << <b>Move</b> button, so that it is highlighted.
2	Touch the file(s) on the <b>Application Directory</b> that you wish to move into the <b>Browse Directory</b> .

**Table 5.7** To move files from the **Browse Directory** to the **Application Directory**

Step	Action
1	Touch the <b>Move&gt;&gt;</b> button, so that it is highlighted.
2	Touch the file(s) on the <b>Browse Directory</b> that you wish to move into the <b>Application Directory</b> .

NOTICE	
	Moving files works the same as Copying with the exception that the source file is deleted after the transfer.

## 5.9.3 Deleting Files

**Table 5.8** To delete files from the either the Application Directory or the Browse Directory

Step	Action
1	Touch the Delete button under the appropriate directory, so that it is highlighted.
2	Touch the files you wish to delete (you will be prompted to confirm).
3	Select <b>Yes</b> to delete the file.
4	Repeat steps 2 and 3 for all the files you wish to delete.

NOTICE	
	If you touch the Select All button when the Delete button is highlighted you will be prompted to confirm the deletion of all the files in the directory.

## 5.10 Run Menu

The Run pull down menu contains the following choices:

### 5.10.1 Operator Screen (When Running a Preset)

**Figure 5.10** Operator Screen (When Running a Preset)

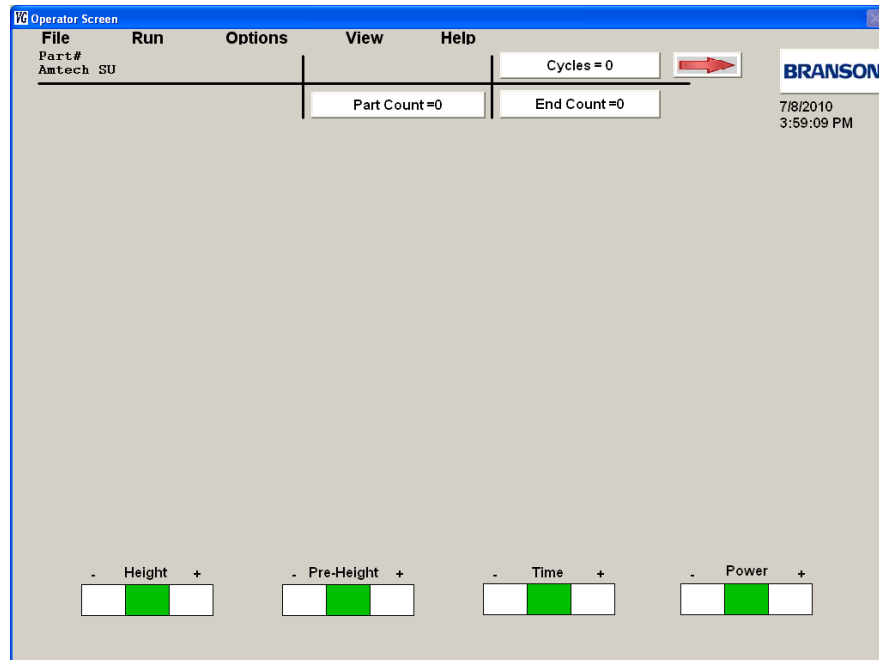

This is the Operator Screen when running a preset. You can choose this screen to be the start screen when you turn on your controller. For information see [5.11.1.5 System Configuration](#).

Displayed on the upper section of the screen are the Preset's name, the part counter (Part Count), cycle counter (Cycles), and the batch size (End Count). The cycle counter keeps track of the amount of welds performed. When the Part Counter equals the End Count the controller will ask if you want to reset the part counter to zero. Touch the **Part Count** or the **Cycles** button to reset the cycle or part counter. Touch the End Count button to enter a new batch size.

Touch the red arrow to switch between the Operator and Setup screens.

When running a preset on the Operator Screen, changes made to the End Count are kept in memory only. The preset name will display a '\*' symbol to note that the preset has not been saved. If a different preset is loaded, the VersaGraphix application is closed, or the VersaGraphix Controller is powered off, unsaved changes will be lost. To save the End Count change to the preset file, select Save Preset from the File menu, or select Save Preset As to save the changes into a new preset file.

NOTICE	
	<p>Unless the preset is saved by selecting Save Preset, all unsaved setup changes will be lost when loading a different preset, closing the VersaGraphix application, or powering off the VersaGraphix Controller.</p> <p>If an image was selected for the preset, it will be displayed on the middle of the screen.</p>

On the bottom of the screen you can see the quality indicators. These indicate visually if the **Height**, **Pre-Height**, **Time**, and **Power** readings fell within the acceptable range for the last weld. They each have three sections. The section in center is the pass section and it will light green when the parameter reading fell within the acceptable range. The left and right sections are, respectively, the fail low, and fail high sections. These sections will light red when the parameter reading fell outside the acceptable range. The controller will also display a pop up window with an alarm message for unsuccessful welds.

**Figure 5.11** Unsuccessful welds pop up window for maximum height



## 5.10.2 Operator Screen (When Running Sequence)

**Figure 5.12** Operator Screen (When Running a Sequence)

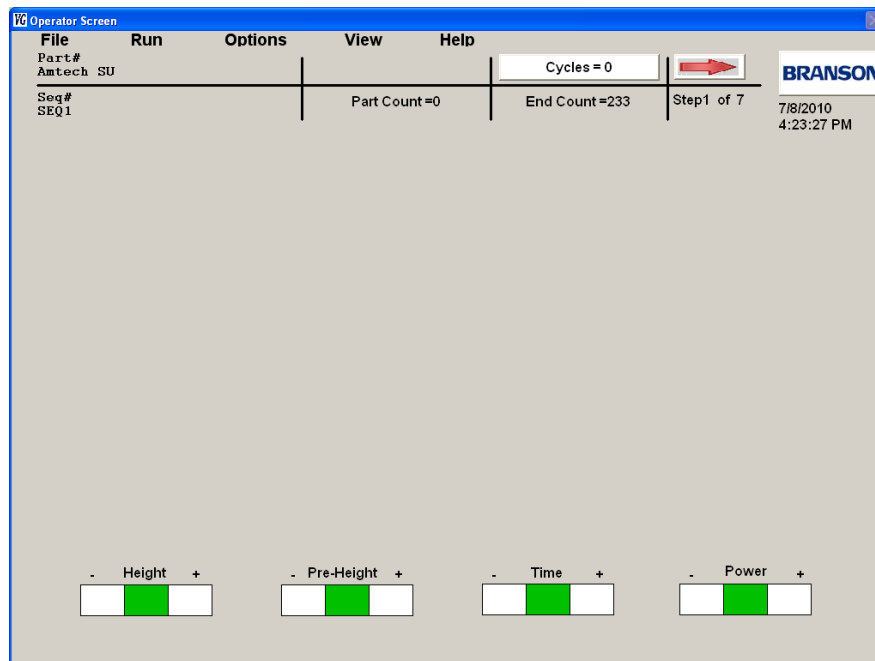

This is the Operator Screen when running a sequence. You can choose this screen to be the start screen when you turn on your controller. For information see [5.11.1.5 System Configuration](#).

Displayed on the upper section of the screen are the sequence's name, the current step's Preset name, the part counter (Part Count), cycle counter (Cycles), the step's batch size (End Count) and the current step number. The cycle counter keeps track of the total amount of welds performed while the part counter keeps track of the welds performed for

the current step. Touch the **Cycles** button to reset the cycle counter. Touch the red arrow on the upper right side of the screen to go the next step on the sequence.

NOTICE	
	<p>If an image was selected for the preset, it will be displayed on the middle of the screen.</p>

On the bottom of the screen you can see the quality indicators. These indicate visually if the **Height**, **Pre-Height**, **Time**, and **Power** readings fell within the acceptable range for the last weld. They each have three sections. The section in center is the pass section and it will light green when the parameter reading fell within the acceptable range. The left and right sections are, respectively, the fail low, and fail high sections. These sections will light red when the parameter reading fell outside the acceptable range. The controller will also display a pop up window with an alarm message for unsuccessful welds.

**Figure 5.13** Unsuccessful welds pop up window for minimum height



### 5.10.3 Setup Screen (When Running a Preset)

**Figure 5.14** Setup Screen (When Running a Preset)

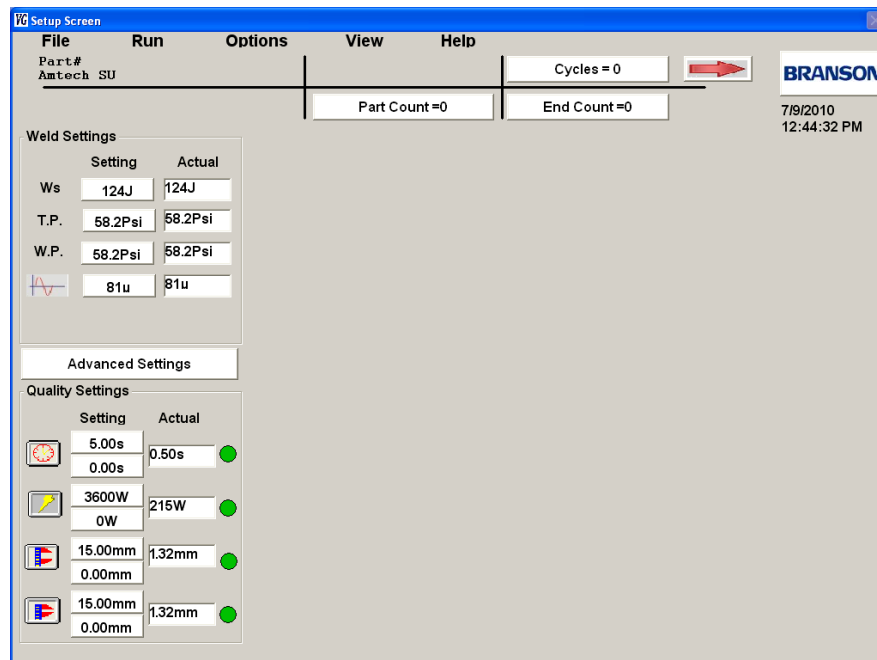

This screen can be used to setup and fine-tune your weld presets. On this screen you can run and edit Weld, Advanced, and Quality settings for your currently loaded preset. You can choose this screen to be the start screen when you turn on your controller. For information see [5.11.1.5 System Configuration](#).

Displayed on the upper section of the screen are the Preset's name, the part counter (Part Count), cycle counter (Cycles), and the batch size (End Count). The cycle counter keeps track of the amount of welds performed. When the Part Counter equals the End Count the controller will ask if you want to reset the part counter to zero. Touch the **Part Count** or the **Cycles** button to reset the cycle or part counter. Touch the End Count button to enter a new batch size.

Touch the red arrow to switch between the Operator and Setup screens.

In the middle of the screen on the left side are the Weld Settings Box, the Advanced Settings button, and the Quality Settings box. On the right side of each quality parameter a circle is displayed. The circle will light green for successful welds and red for unsuccessful welds. If an image was selected for the preset, it will be displayed on the screen. The controller will also display a pop up window with an alarm message for unsuccessful welds:

**Figure 5.15** Result taller than maximum height message



While on the Setup Screen, when running a preset, all changes made to a preset setup are kept in memory only. The preset name will display a ' \* ' symbol to note that the preset has not been saved and a Save Preset Button will appear in the lower-left section of the screen.

If a different preset is loaded, the VersaGraphix application is closed, or the VersaGraphix Controller is powered off, unsaved changes will be lost. To save the setup changes to the preset file, touch the Save Preset button, select Save Preset from the File menu, or select Save Preset As to save the changes into a new preset file.

NOTICE	
	<p>Unless the preset is saved by selecting Save Preset, all unsaved setup changes will be lost when loading a different preset, closing the VersaGraphix application, or powering off the VersaGraphix Controller.</p>

### 5.10.3.1 Weld Settings

In the Weld Settings box you can see the actual readings for the last weld on the rightmost column. You may alter the parameter settings by touching the buttons on the center column. The parameters:

**Watt/seconds (Ws):** The amount of energy (in joules) delivered on each weld.

**Trigger Pressure (T.P):** The clamping pressure that needs to be exerted to the parts before applying ultrasonic energy.

**Weld Pressure (W.P):** The clamping pressure applied to the parts during a weld.

**Amplitude (  ):** The amplitude (in microns) of the applied ultrasonic vibration. If an amplitude stepping mode has been selected on the Advanced Settings window, you will be able to enter Amplitude A, Amplitude B, and a Step Point.

### 5.10.3.2 Quality Settings

In the Quality Settings box you can see the actual readings for the Time, Energy, Pre-Height, and Height of the last weld. You may also adjust the acceptable range for the following quality parameters

**Time(  ) max/min:** The max/min time that the ultrasonic energy may be applied to a weld.

**Energy(  ) max/min:** The max/min power which may be applied to a weld.

**Pre-Height(  ) max/min:** The max/min height of the parts before welding. This is a pre-welding inspection reading from the height encoder.

**Height (  ) max/min:** The max/min height of the resulting weld.

### 5.10.3.3 Advanced Settings Screen

**Figure 5.16** Advanced Settings screen

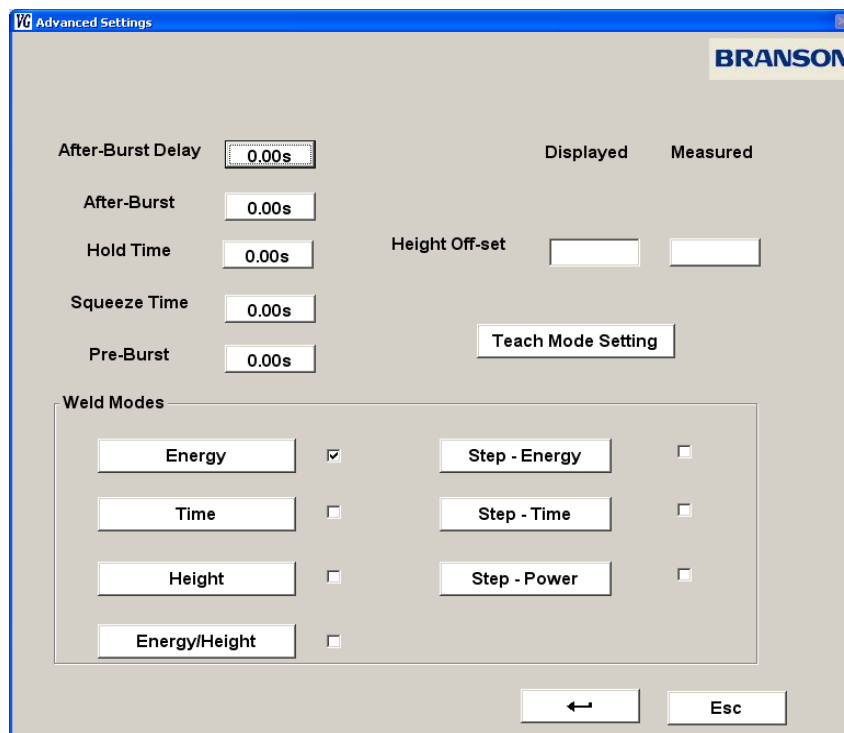

This window allows access to the advanced weld settings described below. These values will normally reflect the default settings made in the Configuration Settings screen on the Settings tab. Values set on this window will only affect the current preset's settings.

## Parameters:

- **After Burst (s):** Used to fire sonics for a predetermined amount of time after the weld is complete and after After burst delay times out
- **After Burst Delay (s):** Used to delay after burst. Delay should be set so that no force is on the part
- **Hold time (s):** Delays the release of the weld. Used to remove discoloration from the weld
- **Squeeze Time (s):** Delay the weld for a predetermined amount of time. Allows the force of the cylinder to build up on the part before welding
- **Pre Burst (s):** Used to fire sonics for a predetermined amount of time after the Squeeze Time and before capturing the Pre-Height. Used when welding magnet wire. It helps to break up the insulation around the copper, and provide a small cooling period before the weld takes place

## Weld Modes:

- **Energy:** Ultrasonics are activated until the specified amount of Energy (Watts integrate over time) has been applied
- **Time:** Ultrasonics fire for a predetermined amount of time
- **Height:** Ultrasonic energy is applied until a predetermined height is reached
- **Energy/Height Compensation:** Used for contaminated parts. The controller will first put in the predetermined amount of Energy, it will then look at the final height window. If the final height is not within the window, the controller will then put in up to 3 times more energy to get to the center of the window. Note quality window for time may need to be adjusted when using this mode. Controller will shut down when the upper time limit is exceeded
- **Amplitude stepping:** There are three stepping modes available: Step - Energy, Step - Time, and Step - Power. If a stepping mode is selected, you must also set the start amplitude, end amplitude, and a step point. After choosing a stepping mode, set the start amplitude, end amplitude and step point by editing the Amplitude setting located in the Weld Settings area of the Setup screen. See Section [2.5.8 Amplitude Stepping](#) for more information

## Off-set:

- **Height Off-set:** Displays the height measurement for the last weld. Touching the button under the Measured column allows the user to enter the height he measured on the last welded piece. The controller automatically adds a corrective offset to its measurements, so displayed values to match the user's measurements

## Teach Mode Setting:

- **Global:** Select Global to use the Teach Mode settings set on the Teach tab on the configuration screen. For more information, see Section [5.11.1.3 Teach Mode Settings](#)
- **Special:** Select Special to enter different Teach Mode settings for the current preset

## 5.10.4 Setup Screen (When Running a Sequence)

Figure 5.17 Setup Screen (When Running a Sequence)

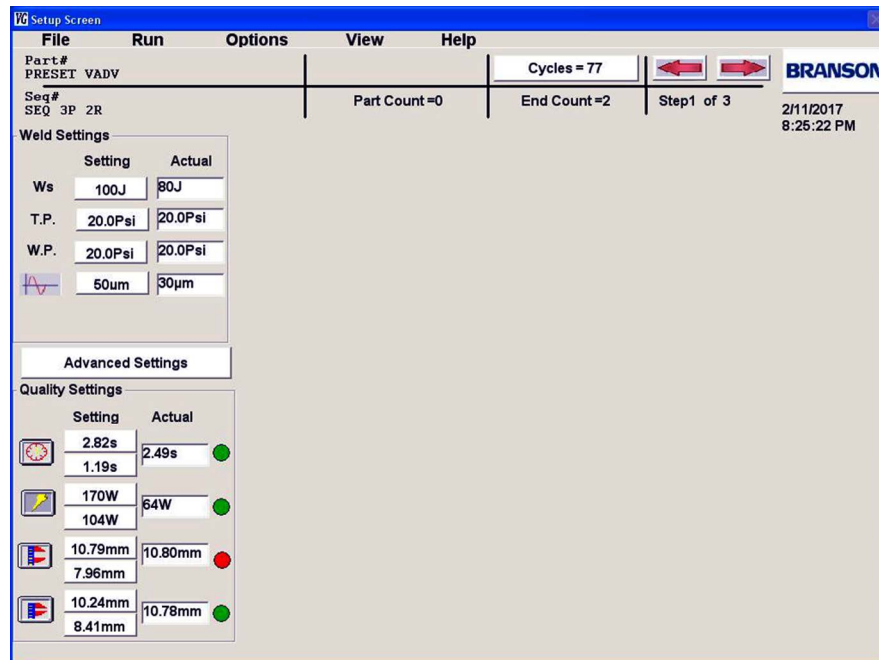

This screen can be used to monitor actual weld and quality results for each weld. You can choose this screen to be the start screen when you turn on your controller. For information see [5.11.1.5 System Configuration](#).

NOTICE	
	<p>While on the Setup Screen, no changes can be made to the preset settings.</p>

Displayed on the upper section of the screen are the sequence's name, the current step's Preset name, the part counter (Part Count), cycle counter (Cycles), the step's batch size (End Count) and the current step number. The cycle counter keeps track of the total amount of welds performed while the part counter keeps track of the welds performed for the current step. Touch the **Cycles** button to reset the cycle counter. There are two red arrows on the upper right side of the screen. Touching the arrow pointing to the left will take you to the previous step on the sequence. Touching the arrow pointing to the right will take you to the next step on the sequence.

In the middle of the screen on the left side are the Weld Settings Box, the Advanced Settings button, and the Quality Settings box. On the right side of each quality parameter a circle is displayed. The parameters shown are the same as the ones described in sections [5.10.3.1 Weld Settings](#), [5.10.3.2 Quality Settings](#), and [5.10.3.3 Advanced Settings Screen](#), but they cannot be modified within the sequence. The circle will light green for successful welds and red for unsuccessful welds. The controller will also display a pop up window with an alarm message for unsuccessful welds.

**Figure 5.18** Result taller than minimum height message





## 5.10.5 Teach Mode Screen

In the Teach Mode screen, the controller automatically derives the quality window's limits based on calculations performed on results from a weld sample set. It is operational in three run screens: Setup Screen, Operator Screen and Statistical Analysis Screen. There are three available teach modes: Standard Teach Mode, Auto Teach Mode, and Sigma Teach Mode. To run Teach Mode click on: Run > Teach Mode Screen. The controller will run in the teach mode currently selected in the TEACH tab in the Configuration Settings window. See [5.11.1.3 Teach Mode Settings](#).

NOTICE	
	<p>While in any of the Teach Modes, the screen background is orange and the Quality settings are not editable.</p>

NOTICE	
	<p>Exit the Teach Mode by closing the application, loading a Preset/Sequence, Saving/Editing a Preset/Sequence, or by switching to following screens: Run New Preset/Sequence, File Manager, Maintenance, Configuration Settings, and Administrator.</p>

NOTICE	
	<p>You can switch between the Operator Screen, Statistical Analysis screen, Weld Graph screen, Weld History screen and Error Log screen without affecting the Teach process. While in teach mode, the Operator Screen and Statistical Analysis screen will also be shown in orange background.</p>

NOTICE	
	To start a new Teach process click [Run -> Teach Mode Screen] and select the required preset to be loaded from the list.

NOTICE	
	If you change any Weld/Advanced settings at any time, the Teach mode restarts with wide open quality windows. The preset will be saved at this point.



#### 5.10.5.1 Standard Teach Mode

In the Standard Teach Mode the default quality windows (wide open) are used, and you may accept or reject each weld as part of the sample set. Upon successful completion of the sample set, the average values for Time, Power, Pre-Height, and Height are computed; the allowable min./max deviation percentages are factored in; and the resultant is used to calculate the weld settings and the quality window settings. The quantity of samples to be run and the allowable deviation percentages for each weld parameter are set in the TEACH tab in the Options > Configuration window. See [5.11.1.3 Teach Mode Settings](#). After completing the Teach process, the Preset and the quality windows settings are saved; the gray Operator Screen is displayed; and you will no longer be in Teach Mode.

#### 5.10.5.2 Auto Teach Mode

In the Auto Teach Mode you may not reject samples. If no changes are made to the Weld/Advanced settings, the previously saved quality windows are used for the first five welds, which form a basis. Their averaged values for Time, Power, Pre-Height and Height, plus or minus ten percent tolerance, are used to evaluate the acceptability of the remaining samples. If one of the remaining samples falls outside of this range, it is rejected and an alarm occurs. Up to three welds may be rejected in a teach session. If a fourth bad weld is encountered the Auto Teach process starts over with wide open quality windows. The run quantity for Auto Teach Mode can be set in the Teach tab in the Configuration settings window. When the Teach process is complete, the Preset and the quality window settings are saved; the gray Operator Screen is displayed; and the system will be in monitoring mode. While in monitoring mode you can weld normally. The system will restart a complete Auto Teach session automatically if you change any of the weld parameters, quality windows settings, recall a new preset, or go to the File Manager, Maintenance, Configuration or Administration screens.

NOTICE	
	In Auto Teach mode File > Create New Sequence, File > Edit Sequence, Run > New Preset, and Run > New Sequence menu options are always grayed out.

NOTICE	
	<p>If you go to the Statistical Analysis or the Operator Screen just after selecting Auto Teach option in Configuration screen, the application will go directly into monitoring mode and you will be allowed to weld normally with the currently loaded preset.</p>
NOTICE	
	<p>If Auto Teach mode is left selected in the configuration screen before powering down, the system will display the operator screen; load the previously loaded preset or default preset; and go directly in to monitoring mode in Auto Teach mode on the next power up.</p>
NOTICE	
	<p>After Creating a New preset while in Auto Teach mode both Run &gt; Operator Screen and Run &gt; New Sequence menu options are grayed out. The only way to weld is to first go through the Auto Teach process for the newly created preset by clicking Run &gt; Teach Mode Screen.</p>

### 5.10.5.3 Sigma Teach Mode

The Sigma Teach mode collects data for the last 128 samples taken for each weld. It limits itself to the last 128 samples to keep data and statistics that will be meaningful to the current sample. The Sigma Teach mode calculates the average and standard deviation for each or the monitored parameters (Time, Power, Preheight, and Height). The early samples are displayed starting on the left of the screen and, as they are added, continue from the left to right.

At 128 and later samples, the oldest data point on the left is removed and the latest data point is added at the right position. Average and standard deviation are always based on the latest data. Removed data has no influence on the calculations.

Standard deviation is calculated with an (n-1) weighting. This tends to make the smaller values of the n have wider standard deviations.

The collected data is displayed between the Upper Specification Limit (USL) and the Lower Specification Limit (LSL). These are the limits as shown on the Run screen. If there are more the 3 samples in the data a Gaussian curve is displayed. The Gaussian curve is positioned between the limits and as much of its data as possible is displayed. There are markers on the curve to show 1, 2, 3, 4, 5, standard deviations. The 1, 2, and 3 markers

are vertical while the 4 and 5 are horizontal (see [Figure 5.19 Sigma markers](#) below). The most desirable situation is narrow limits with a tight curve.

**Figure 5.19** Sigma markers

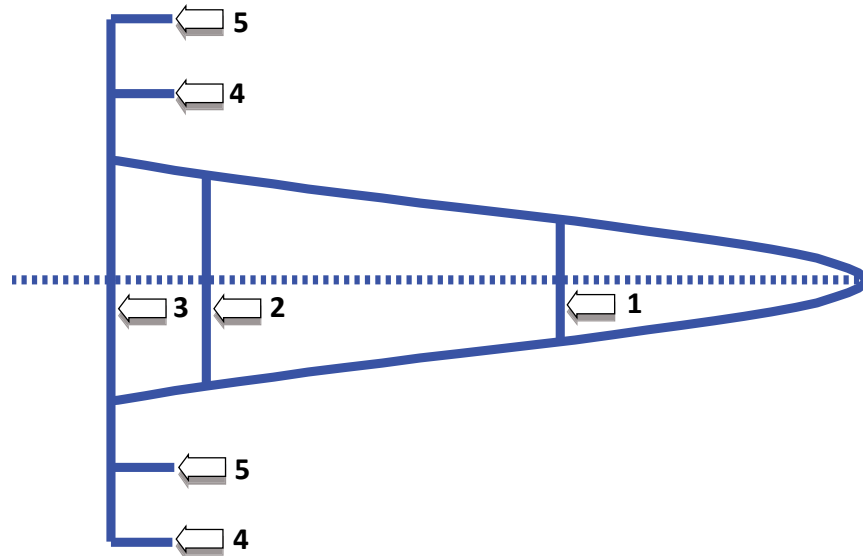

After completing the Teach process, the Preset and the quality windows settings are saved; the gray Operator Screen is displayed; and you will no longer be in Teach Mode.

## 5.11 Options Menu

The Options pull down menu contains the following choices:

### 5.11.1 Configuration

User is allowed to configure the following features of the application.

- Actuator
- Default Setup
- Teach
- System Configuration
- Com Settings

#### 5.11.1.1 Actuator

The Actuator tab found in the Configuration screen allows you to setup the VersaGraphix to work with your Actuator model.

**Figure 5.20** Actuator set up screen

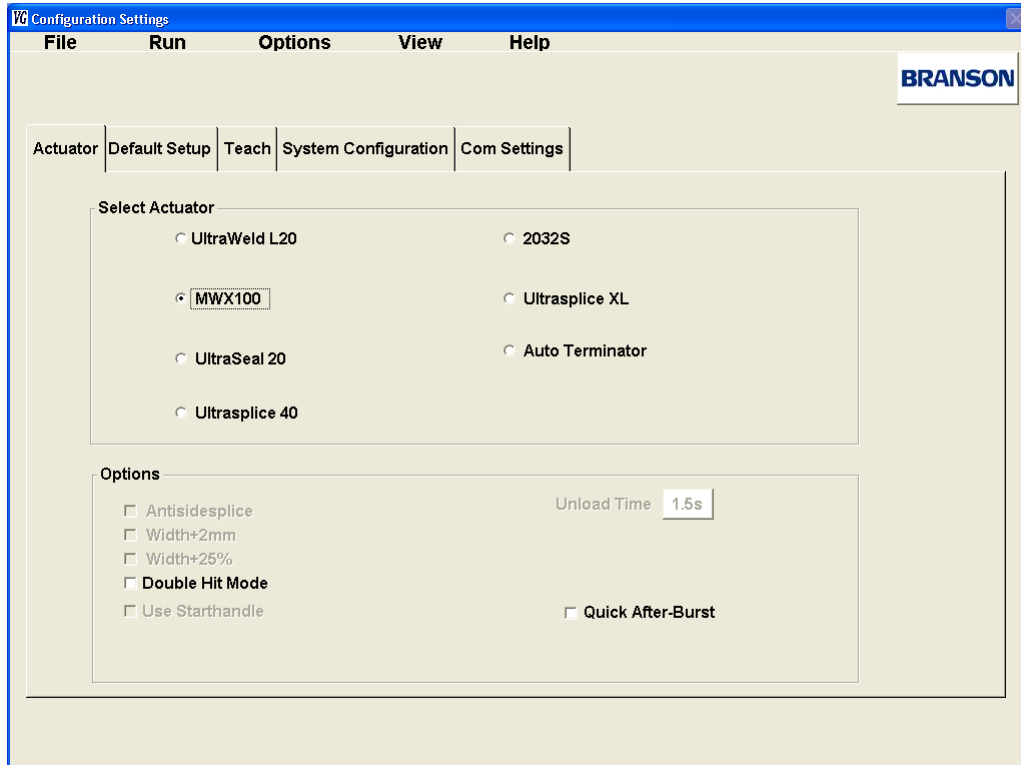

The VersaGraphix can be setup to work with any of the following actuators:

- UltraWeld L20
- MWX100
- Ultraseal 20
- Ultrasplice 40
- Ultrasplice XL
- Auto Terminator

On this tab you may also set the following:

- Double Hit Mode: Used for Automation. Do not activate unless instructed by Branson
- After Burst: A short duration (burst) of ultrasonic energy that begins after the weld is complete and at 1mm from the final height reading. Used when the splice nugget is sticking to the tooling
- Quick After Burst: The after burst function is implemented immediately after each weld cycle finished without any time delay or condition judgment

### 5.11.1.2 Default Preset Settings

**Figure 5.21** Default Preset settings screen

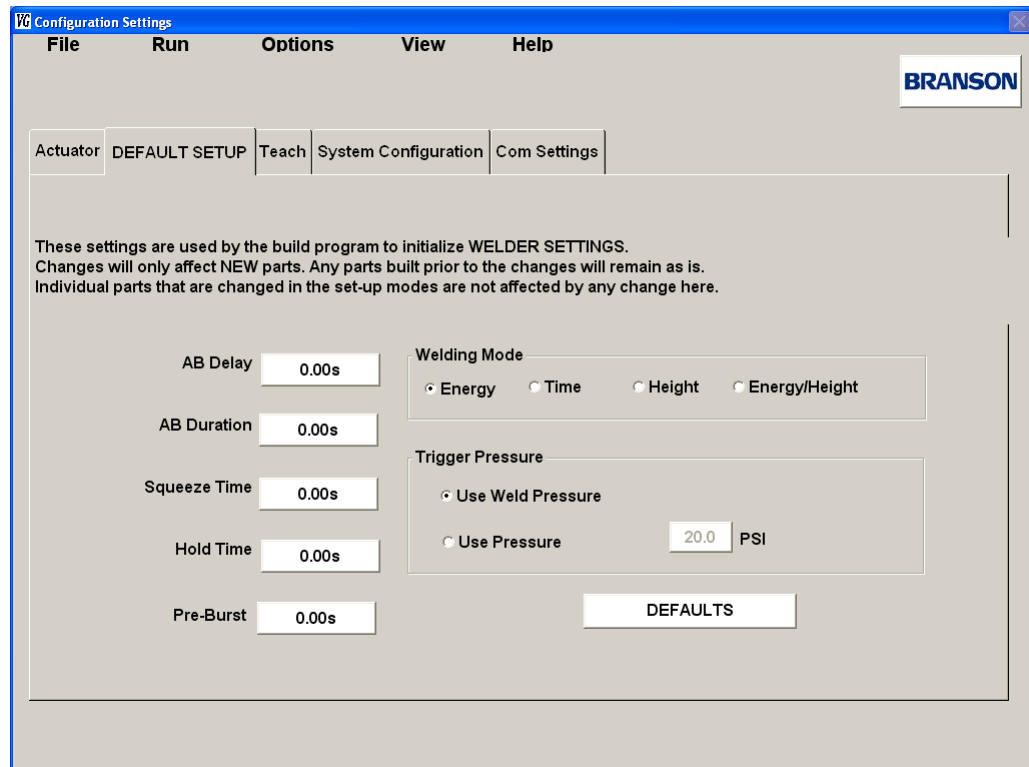

Set the default weld settings for all new presets on the Default Setup tab. These settings will only affect new presets. You may set the following parameters:

- AB Delay
- AB Duration
- Squeeze Time
- Hold Time
- Pre-Burst
- Welding Mode
- Trigger Pressure

See [5.10.3.1 Weld Settings](#) and [5.10.3.3 Advanced Settings Screen](#) for more information on these parameters.

### 5.11.1.3 Teach Mode Settings

**Figure 5.22** Teach Mode Settings screen

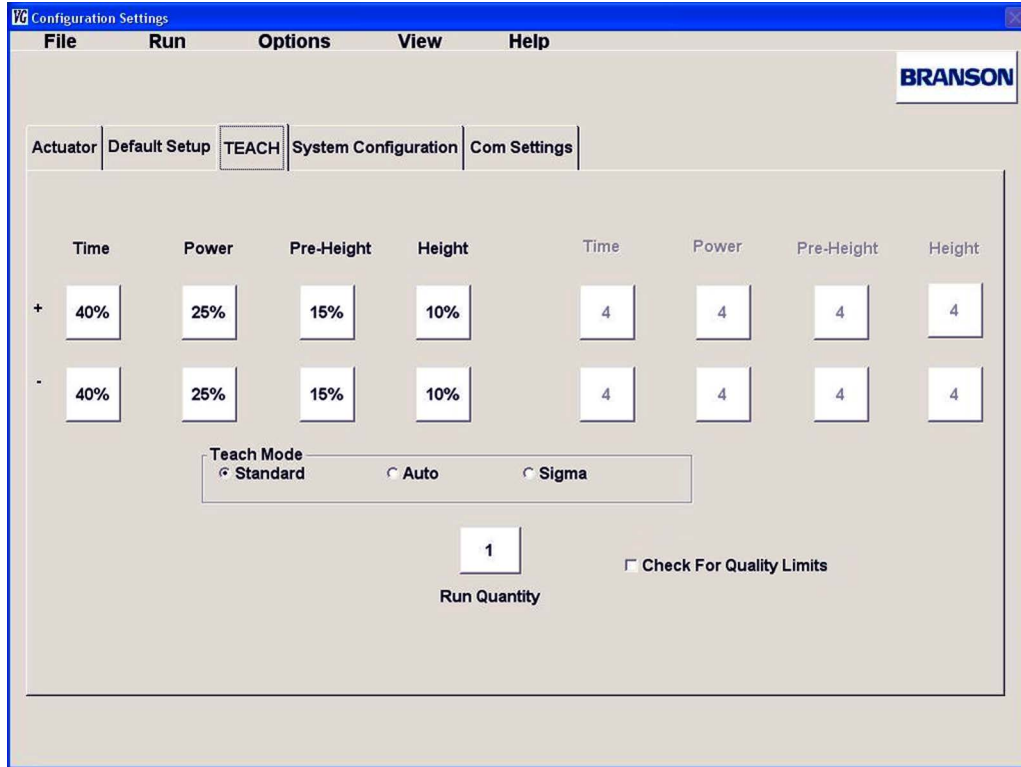

On the Teach tab you may select the teach mode the VersaGraphix will use. There are three different teach modes available: Standard, Auto, and Sigma. On this tab you can set the run quantity and allowable deviation percentages for the Standard or Auto teach modes. See [5.10.5 Teach Mode Screen](#) for more information on Teach modes.

### 5.11.1.4 Check for quality limits

Add the "check for quality limits" check box in the teach tab of the configuration menu to enable/disable (turn ON/OFF) the "Check for Quality Limits" mode. When in the "Check for Quality Limits" mode, if the recalled preset has never been through the teach mode yet, then the preset will be automatically recalled into the teach mode menu; else the system will work as usual and go to Run mode with the recalled preset. If the check box is disabled, the system will also work as usual. In this scenario, all the splices/presets of sequence need to be checked in the sequence mode when a new sequence is recalled. An error message will be shown up on the screen as long as there is anyone unqualified splice/preset in the recalled sequence. Error Message says the following: "Teach Mode Required" then shows the unqualified splice/preset.

### 5.11.1.5 System Configuration

Figure 5.23 System Configuration screen

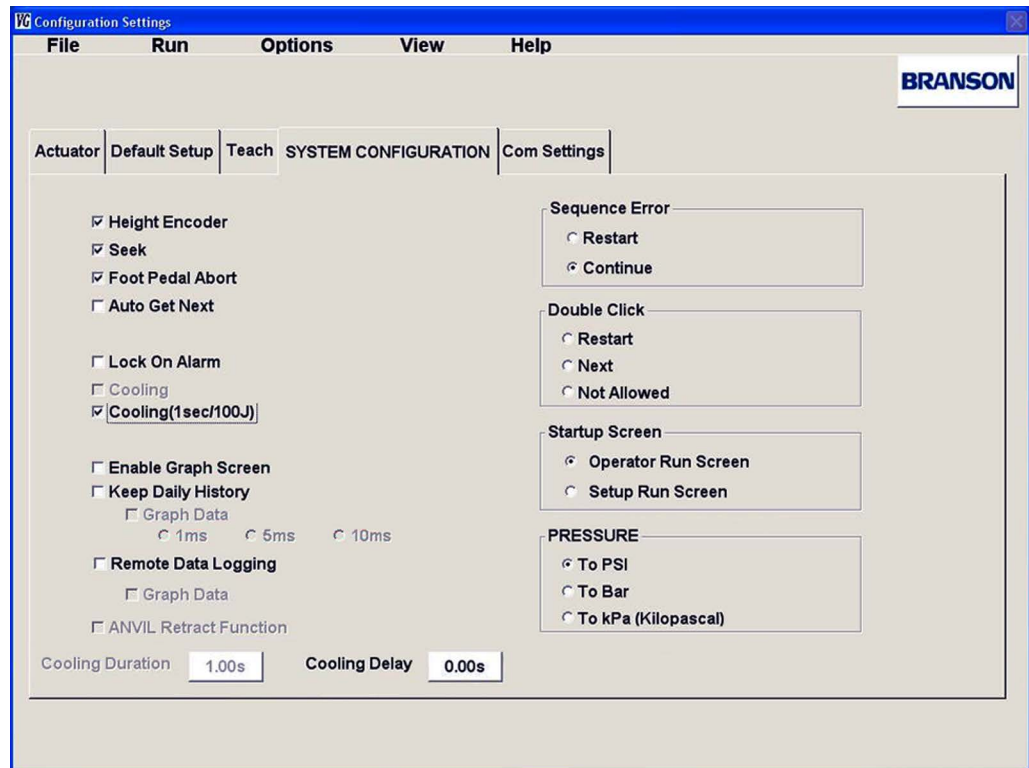

**Height Encoder:** Toggles the height encoder on/off.

**Seek:** Toggles Seek function on/off. This pulses ultrasonic energy to the stack prior to each weld in order to allow the system to tune to stack frequency.

**Foot Pedal Abort:** When this box is checked, foot pedal must be maintained until sonic starts or the weld cycle will be aborted.

**Auto Get Next:** When this box is checked the Controller automatically sequence to the next part. Used in sequencing.

**Lock On Alarm:** Toggles between locking or allowing a weld to continue when an alarm condition exists. When set to lock the actuator will not release the part until a password is entered.

**Cooling:** Enables the setting of a predetermined amount of time the cooling air will stay on after a weld.

**Cooling(1sec/100J):** Automatically sets cooling duration after a weld to 1 second per 100J of energy applied.

**Enable Graph Screen:** Enable/disable Power Graph data.

**Keep Daily History:** When this box is checked the Controller will create a daily folder on the hard drive to store all weld results. If the **Graph Data** box is checked the Controller will also store the weld power readings, sampled every 1ms, 5ms or 10ms (depending on the option that is selected) into a text file.

**Remote Data Logging:** When this box is checked the Controller will send weld results out the Ethernet port at the end of each weld cycle. If the **Graph Data** box is checked the Controller will also send the weld power readings, sampled every 1ms, 5ms or 10ms (depending on the option that is selected).

**Sequence Error:** Sets what the Controller should do when a weld error occurs when running a sequence. It has two Options:

- Restart - to restart the sequence from step 1
- Continue - To reweld the same step in the sequence

**Double Click:** Sets double click action when running a sequence. The options are:

- Restart the sequence - to restart the sequence from step 1
- Next - to move to the next step of the weld sequence
- Not allowed - to disable double click inputs

**Startup Screen:** Sets the screen that will be displayed on powerup. The options are:

- Operator Run Screen
- Setup Run Screen

**Cooling Duration:** To change the amount of time the cooling air is on after each weld cycle.

**Pressure:** Toggles pressure units between the 3 options available:

- To PSI
- To Bar
- To kPa (Kilopascal)

**Cooling Delay:** To change the delay period after a weld and before cooling is turned on.

## 5.11.1.6 COM Settings

Figure 5.24 COM settings screen

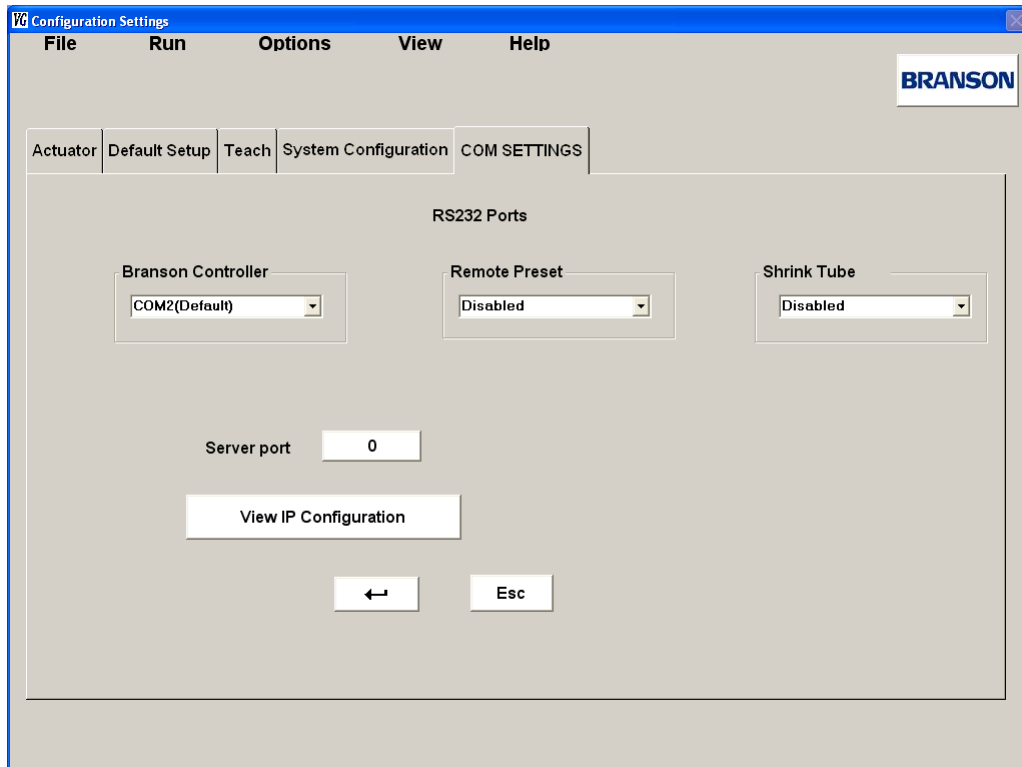

On the COM SETTINGS tab you can configure serial port and Ethernet settings to communicate to its internal controller and an external devices.

## Branson Controller:

The Branson Controller is connected to port COM2 by default.

## Remote Preset:

Presets and sequences can be recalled by an external user application connected to one of the available RS-232 serial ports. Use this drop-down selection list to set the serial port to which the application will be connected. The ports available for Remote Preset recall are COM1, through COM4. Baud rate is fixed at 115000 baud.

To recall a Sequence or Preset, a string containing the 'Preset Name' or a 'Sequence Name' followed by a carriage return must be sent by the user application:

**NAME<CR>**

NOTICE	
	The application will search sequences first, then search presets.

Sequence or Preset to the VersaGraphix application.

The VersaGraphix application returns one of three responses:

**sNAME<CR><LF>** Application found sequence.

**pNAME<CR><LF>** Application found preset.

**nNAME<CR><LF>** Application found neither a sequence or a preset or it found a sequence with a missing preset.

The VersaGraphix application will timeout after 5 seconds if characters are sent without a carriage return **<CR>**. A response "Timeout" will be sent and the receive buffer will be reset.

## Shrink tube:

The VersaGraphix Controller can be connected to an external Raychem® RBK-ILSProcessor shrink tube machine. Use this drop-down selection list to set the serial port to which the shrink tube machine will be connected.

## View IP Configuration:

Displays the current IP configuration.

**Figure 5.25** Current IP Configuration display

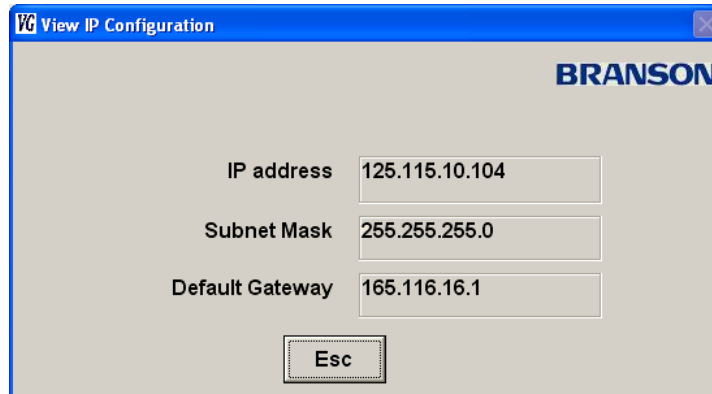

NOTICE	
	The Host IP Address must be set from the Microsoft XP Control panel.

## Server Port:

Sets the server port that will be used to communicate between the VersaGraphix and user data logging application.

## 5.12 Remote Data Collection

At the end of each weld cycle the VersaGraphix writes a line to the daily history log file if "Keep Daily History" is enabled.

This special will echo this line to a remote user application through an Ethernet socket connection. For this special the data format will be hard coded.

A header will be sent every time the user connects to the socket.

### 5.12.1 Connection to VersaGraphix SBC will be through a TCP/IP socket

NOTICE	
	<p>The Unified Write Filter (UWF) must be disabled when configuring the SBC's Network Connections.</p>

The 'Host IP Address' will be set outside the application at the system level.

- Exit the VGX application
- Disable the UWF

#### UWF Configuration Utility

The UWF Configuration Utility is a command-line tool designed to manage the Unified Write Filter (UWF) on Windows systems. It allows users to enable or disable disk protection, add or remove files/folders from the exemption list, and manage UWF settings.

#### Prerequisites

- Administrative privileges are required to run this utility.

#### Running the Utility

1. Navigate to the directory containing the "UWF Configuration Utility.cmd" file:  
C:\UWF Configuration Utility\
2. Right-click on the "UWF Configuration Utility.cmd" file.
3. Select "Run as administrator" from the context menu.

## Main Menu

Figure 5.26 Main Menu

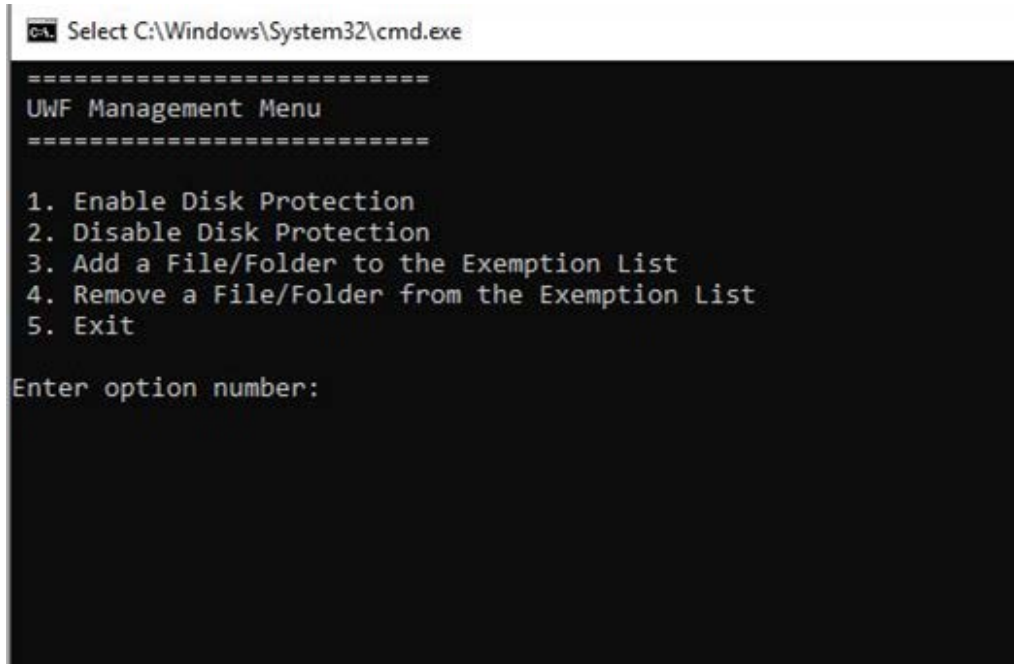

```
C:\> Select C:\Windows\System32\cmd.exe

=====
UWF Management Menu
=====

1. Enable Disk Protection
2. Disable Disk Protection
3. Add a File/Folder to the Exemption List
4. Remove a File/Folder from the Exemption List
5. Exit

Enter option number:
```

Upon running the script, the main menu will be displayed with the following options:

1. Enable Disk Protection
2. Disable Disk Protection
3. Add a File/Folder to the Exemption List
4. Remove a File/Folder from the Exemption List
5. Exit

### Menu Options

1. Enable Disk Protection
  - Protects the C: drive with UWF.
  - Changes will take effect after a system restart.
  - The system will automatically restart after enabling protection.
2. Disable Disk Protection
  - Removes protection from the C: drive.
  - Changes will take effect after a system restart.
  - The system will automatically restart after disabling protection.
3. Add a File/Folder to the Exemption List
  - Prompts for the path of the file/folder to be added to the exemption list.
  - Ensures the specified path exists before adding it to the exemption list.
  - Changes will take effect after a system restart.
4. Remove a File/Folder from the Exemption List
  - Prompts for the path of the file/folder to be removed from the exemption list.
  - Ensures the specified path exists before removing it from the exemption list.
  - Changes will take effect after a system restart.
5. Exit
  - Exits the utility.

## Error Handling

- If UWF is already enabled, the utility will notify the user and proceed to the main menu.
- If an error occurs while enabling UWF, the utility will notify the user and exit.
- If an invalid option is selected from the menu, the utility will prompt the user to enter a valid option.

## Notes

- Ensure all paths entered for adding or removing exemptions are correct and exist on the system.
- The system will restart automatically to apply changes when enabling or disabling disk protection.
- Allow the unit to reboot
- Exit the VGX application
- Set the 'Host IP Address' in Windows

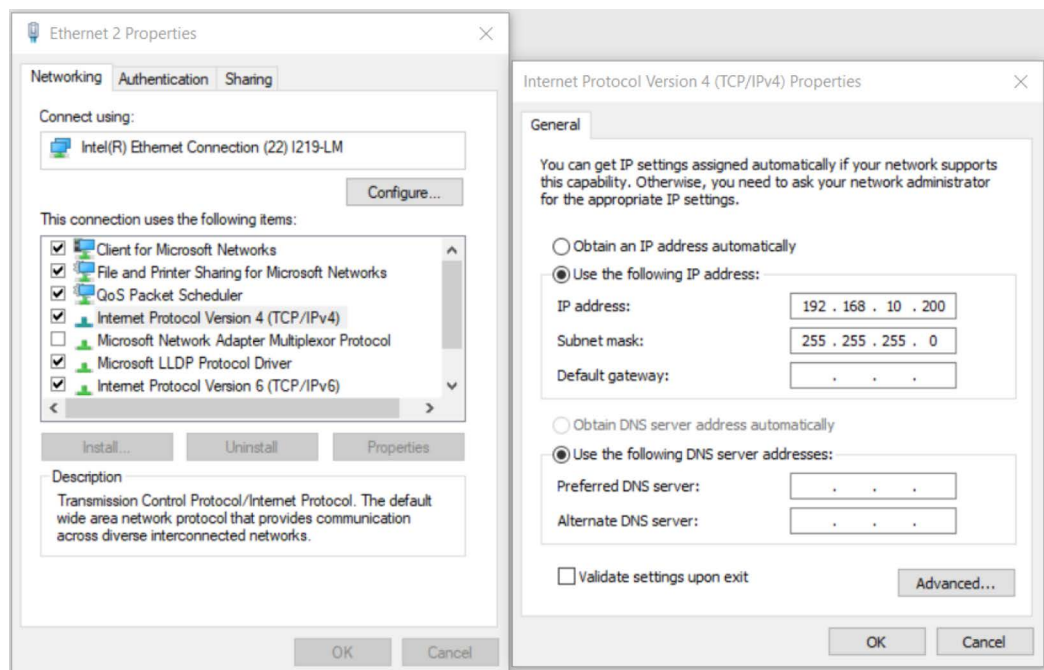

- Open the VGX application
- Set the 'Server Port Number' to 4200.

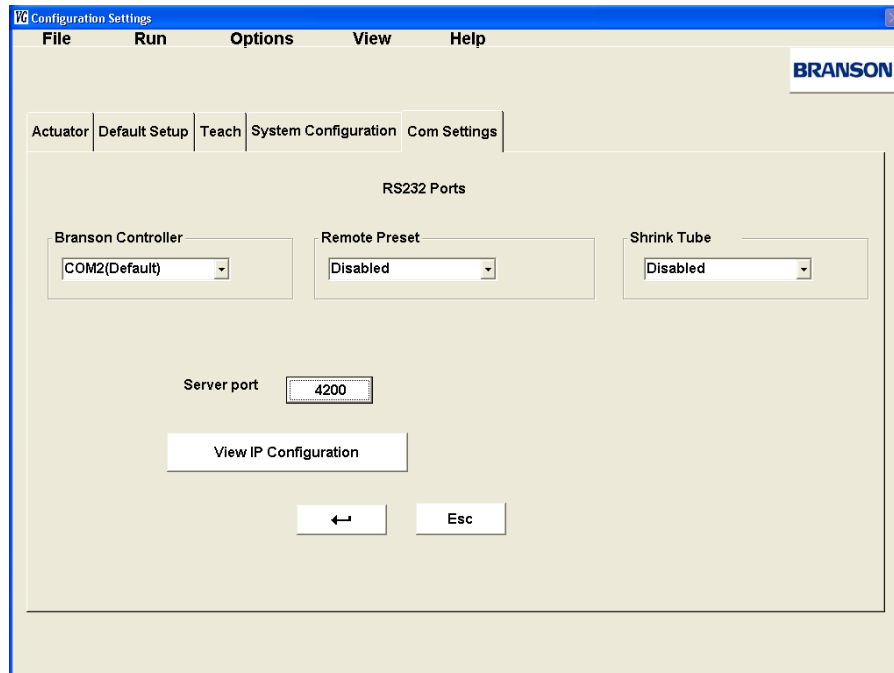

- Options/Configuration/COM SETTINGS/Server Port'. Default= 4200

## 5.12.2 Testing Remote Data Collection

- Testing and verification will be done using TeraTerm
- Connect to the VersaGraphix SBC using an Ethernet Cable
- Start TeraTerm Terminal on the remote PC
- Connect Using: TCP/IP
- Host Address: (Use IP address of VersaGraphix SBC)

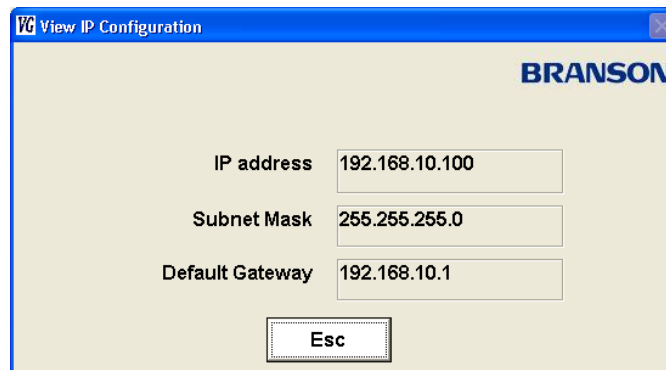

- Port Number: 4200 (default)
- Make a Weld CycleWeld results should be displayed as follows:

The image shows a TeraTerm terminal window displaying a table of Weld CycleWeld results. The table has columns for Cycle count, Date, Time, Part Name, Process Parameters, Energy Trigger, Pressure, Amplitude, Quality Windows, Time, Power, Preheight, Height, and Util.

Cycle count	Date	Time	Part Name	Process Parameters	Energy Trigger	Pressure	Amplitude	Quality Windows	Time	Power	Preheight	Height	Height	Util
17	1/23/2019	11:01:42 AM	Antech SU	200 20.00 20.0 72	5.00	0.00	3960	0	15.00	0.00	15.00	0.00	3.76	85
18	1/23/2019	11:01:51 AM	Antech SU	200 20.00 20.0 72	5.00	0.00	3960	0	15.00	0.00	15.00	0.00	3.76	86
19	1/23/2019	11:02:00 AM	Antech SU	200 20.00 20.0 72	5.00	0.00	3960	0	15.00	0.00	15.00	0.00	3.76	85
20	1/23/2019	11:02:09 AM	Antech SU	200 20.00 20.0 72	5.00	0.00	3960	0	15.00	0.00	15.00	0.00	3.78	84
21	1/23/2019	11:02:17 AM	Antech SU	200 20.00 20.0 72	5.00	0.00	3960	0	15.00	0.00	15.00	0.00	3.77	84
22	1/23/2019	11:02:27 AM	Antech SU	200 20.00 20.0 72	5.00	0.00	3960	0	15.00	0.00	15.00	0.00	3.78	81
23	1/23/2019	11:02:37 AM	Antech SU	200 20.00 20.0 72	5.00	0.00	3960	0	15.00	0.00	15.00	0.00	3.77	84

## 5.13 View Menu

The pull down View menu contains the following choices:

### 5.13.1 Weld Graph

**Figure 5.27** Weld Graph

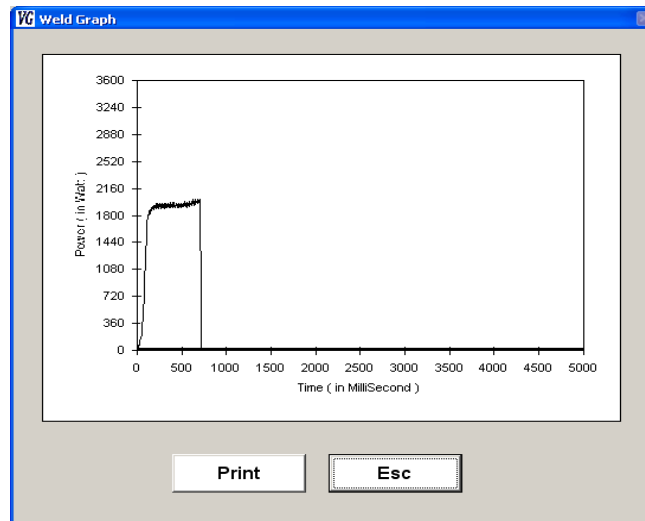

Touch View > Weld Graph to display a pop up window containing a graph of Power (Watts vs. Time) for the last weld performed.

Weld graphs are sometimes referred to as weld “foot print”. They can be used to visualize the weld cycle and assists in parameter optimization. Graphs from consecutive welds will vary slightly as the system dynamically adjusts time to accommodate varying surface conditions. (See [Figure 2.2 Weld Power Graph for clean components, dirty components, and when part is missing](#)).

NOTICE	
	<p>Weld Graph data can be saved into a text file or sent out the Ethernet port. See <a href="#">5.11.1.5 System Configuration</a> for more information.</p>

## 5.13.2 Statistical Analysis Screen

Figure 5.28 Statistical Analysis screen

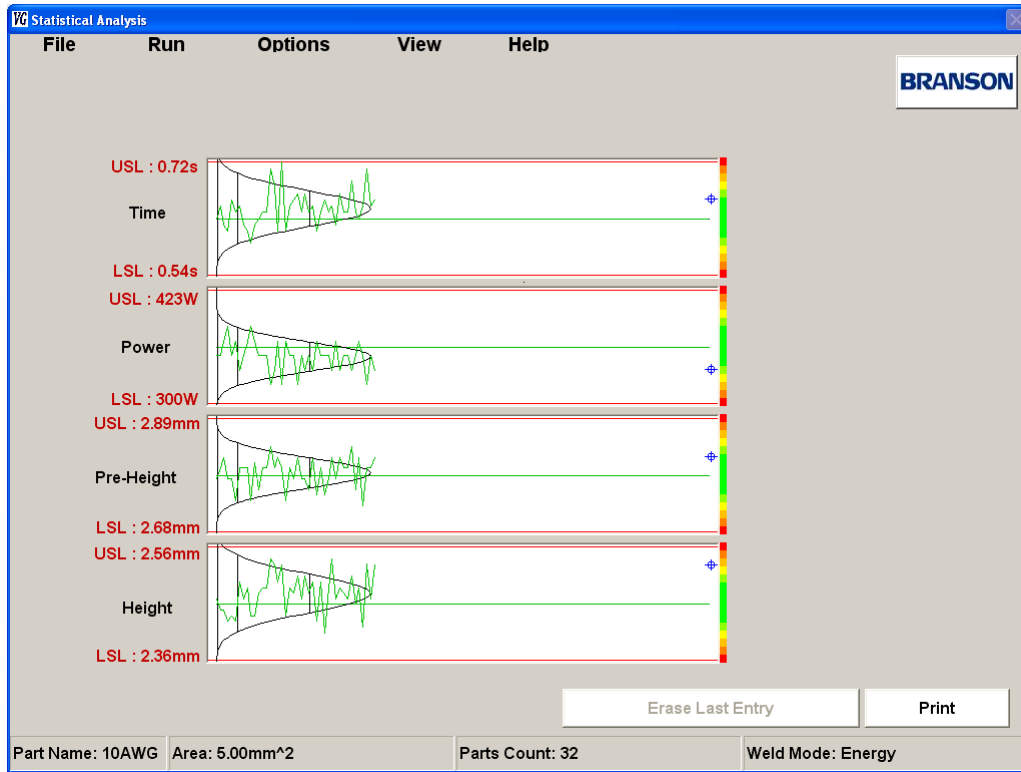

The Statistical Analysis screen displays a histogram and Gauss curves for an accumulation of up to 128 samples of the current part.

The program keeps a file on each part and records each sample as it is run. The file is updated at the end of each weld cycle that does not contain any faults. Weld cycles that contain faults are not included in the data nor is the parts counter increments. The file contains data for the last 128 weld cycles for the current part. If less than 128 cycles are available, only those available are displayed. If more than 128 parts are on the counter, the file is updated by discarding the oldest sample data and adding the latest sample data. The average, standard deviation, and Gauss curves are based on the latest data.

The labels USL and LSL are the upper and lower Specification Limits set on the Setup Screen. The Gauss curves are displayed proportional to the upper and lower specification limits and have markers for the 1, 2, 3, 4, 5 and 6 sigma deviations if they fall inside the limits. No Gauss curves are displayed if the parts counter is less than 3.

## 5.13.3 Error Log

Figure 5.29 Error Log

Date/Time	Part Name	Error	Value
08-Oct-08 3:44:44 PM	10AWG	Height	2.45mm
08-Oct-08 3:44:35 PM	10AWG	Height	2.41mm
08-Oct-08 3:18:16 PM	10AWG	Power	2272W
08-Oct-08 3:10:12 PM	10AWG	Pre-Height	2.60mm
08-Oct-08 3:10:10 PM	10AWG	Pre-Height	2.62mm
08-Oct-08 3:03:00 PM	10AWG	Height	2.35mm
08-Oct-08 3:02:58 PM	10AWG	Pre-Height	2.56mm

The Error log keeps track of all unsuccessful welds and their fault cause. You can generate a printout of all errors by touching the Print Data button.

## 5.13.4 Weld History

Figure 5.30 Weld History

Entry	Time	Power	Pre-Height	Height
8	0.62 s	352 W	2.47 mm	2.80 mm
9	0.61 s	368 W	2.49 mm	2.80 mm
10	0.59 s	384 W	2.44 mm	2.74 mm
11	0.62 s	368 W	2.44 mm	2.81 mm
12	0.63 s	352 W	2.48 mm	2.76 mm
13	0.64 s	352 W	2.49 mm	2.80 mm
14	0.64 s	352 W	2.49 mm	2.80 mm
15	0.71 s	320 W	2.54 mm	2.84 mm
16	0.68 s	336 W	2.53 mm	2.80 mm
17	0.61 s	368 W	2.50 mm	2.82 mm
18	0.72 s	320 W	2.53 mm	2.80 mm
19	0.61 s	368 W	2.44 mm	2.74 mm
20	0.65 s	352 W	2.49 mm	2.80 mm
21	0.66 s	352 W	2.48 mm	2.78 mm
22	0.67 s	320 W	2.51 mm	2.82 mm
23	0.64 s	352 W	2.47 mm	2.78 mm
24	0.67 s	336 W	2.51 mm	2.78 mm
25	0.64 s	352 W	2.49 mm	2.76 mm
26	0.65 s	336 W	2.50 mm	2.82 mm
27	0.61 s	368 W	2.43 mm	2.75 mm
28	0.64 s	352 W	2.50 mm	2.80 mm
29	0.66 s	352 W	2.41 mm	2.75 mm
30	0.64 s	352 W	2.49 mm	2.78 mm
31	0.65 s	336 W	2.54 mm	2.82 mm
32	0.62 s	368 W	2.47 mm	2.78 mm
33	0.67 s	336 W	2.49 mm	2.82 mm
34	0.64 s	352 W	2.48 mm	2.80 mm
35	0.64 s	352 W	2.47 mm	2.80 mm
36	0.69 s	336 W	2.51 mm	2.84 mm
37	0.64 s	352 W	2.46 mm	2.76 mm
38	0.63 s	368 W	2.49 mm	2.82 mm
39	0.65 s	352 W	2.42 mm	2.73 mm
40	0.71 s	320 W	2.53 mm	2.80 mm
41	0.65 s	352 W	2.47 mm	2.80 mm

On the Weld History screen you can view all saved weld results. You can generate a printout of all weld results by touching the Print Data button.

NOTICE	
	The Keep Daily History checkbox on the Settings tab on the Configuration screen must be checked for the controller to store weld results.

NOTICE	
	Weld results can also be sent out the Ethernet port at the end of each weld cycle. See <a href="#">5.11.1.5 System Configuration</a> for more information.

## 5.14 Help Menu

In the Help pull down menu you can select About VersaGraphix to view the VersaGraphix software version and Controller version.

**Figure 5.31** VersaGraphix Software version

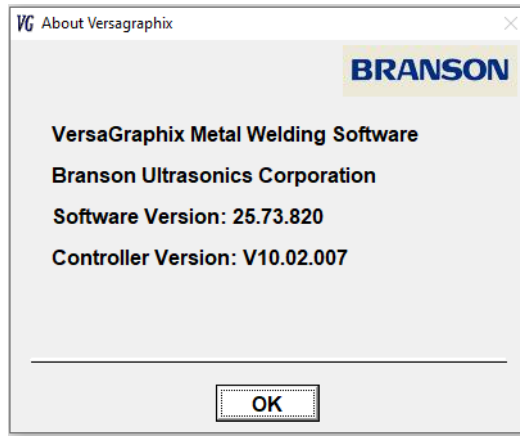

## 5.15 Language Support

Figure 5.32 Language Settings



The VersaGraphix software supports 18 user selectable languages. The supported languages are: English, French, German, Japanese, Russian, Romanian, Portuguese, Spanish, Hungarian, Korean, Polish, Czech, Turkish, Italian, Simplified Chinese, Traditional Chinese, Thai and Slovenian.

NOTICE	
	Touch the Branson logo on any of the screens to pop up the Language Settings window.

---

## **Chapter 6: Maintenance**

---

<b>6.1</b>	<b>Maintenance . . . . .</b>	<b>86</b>
<b>6.2</b>	<b>Preventive Maintenance . . . . .</b>	<b>87</b>
<b>6.3</b>	<b>Parts List . . . . .</b>	<b>88</b>
<b>6.4</b>	<b>Parts Replacement . . . . .</b>	<b>89</b>
<b>6.5</b>	<b>Troubleshooting . . . . .</b>	<b>90</b>
<b>6.6</b>	<b>Service Events . . . . .</b>	<b>92</b>

## 6.1 Maintenance

Safety devices, especially covers, guards and ground cables should only be removed when it is absolutely essential for the completion of maintenance work. If safety devices were removed prior to starting maintenance work, be sure to re-install those devices after finishing the maintenance work. The following installation and maintenance operations must be performed prior to any disassembly of equipment:

WARNING	
	<ul style="list-style-type: none"><li>• All system components must be disconnected from the main electrical supply</li><li>• Remove the plug from the main electrical supply and secure it from being re-inserted accidentally</li><li>• Use LOTO (Lock Out Tag Out) lockable plug cover over line cord plug during any maintenance</li><li>• All system components must be disconnected from the main air supply and system air pressure must be released via the pressure regulator</li><li>• When performing maintenance on the welder, make sure that no other automated systems are active</li></ul>

## 6.2 Preventive Maintenance

The following preventive measures help assure long term operation of your Branson equipment.

### 6.2.1 Periodically Clean the Equipment

Air is continuously drawn into the Branson VersaGraphix Controller. Periodically disconnect the unit from power, remove the cover and vacuum out any accumulated dust and debris. Remove material adhering to the fan blades and motor, transistors, heat sinks, transformers, circuit boards, cooling intake vents, and exhaust ports. Filters can be added to the VersaGraphix cooling fans for dusty environments. External covers may be cleaned with a damp sponge or cloth using a solution of mild soap and water. Do not allow cleaning solution to enter the unit. To prevent rust in areas of high humidity, exposed steel surfaces, such as handles, hardware, and the main column may require a very light film of oil, such as WD-40<sup>®1</sup>.

NOTICE	
	<p>When it is necessary to clean the touch screen, wipe gently with a soft cloth dampened with a mild window glass commercial cleaner or 50/50 mixture of water and isopropyl alcohol. Use a soft cloth moistened with mild detergent to clean the display housing. Do not use abrasive cleaners, waxes or solvents to clean the touch screen monitor.</p>

### 6.2.2 Routine Component Replacement

The lifetime of certain parts is based on the number of cycles the unit has completed, or on hours of operation, e.g., at 20,000 hours, cooling fans should be replaced.

1. WD-40 is a registered trademark of WD-40 Manufacturing Company Corporation.

## 6.3 Parts List

This section provides the list of replacement parts.

**Figure 6.1** VersaGraphix Controller

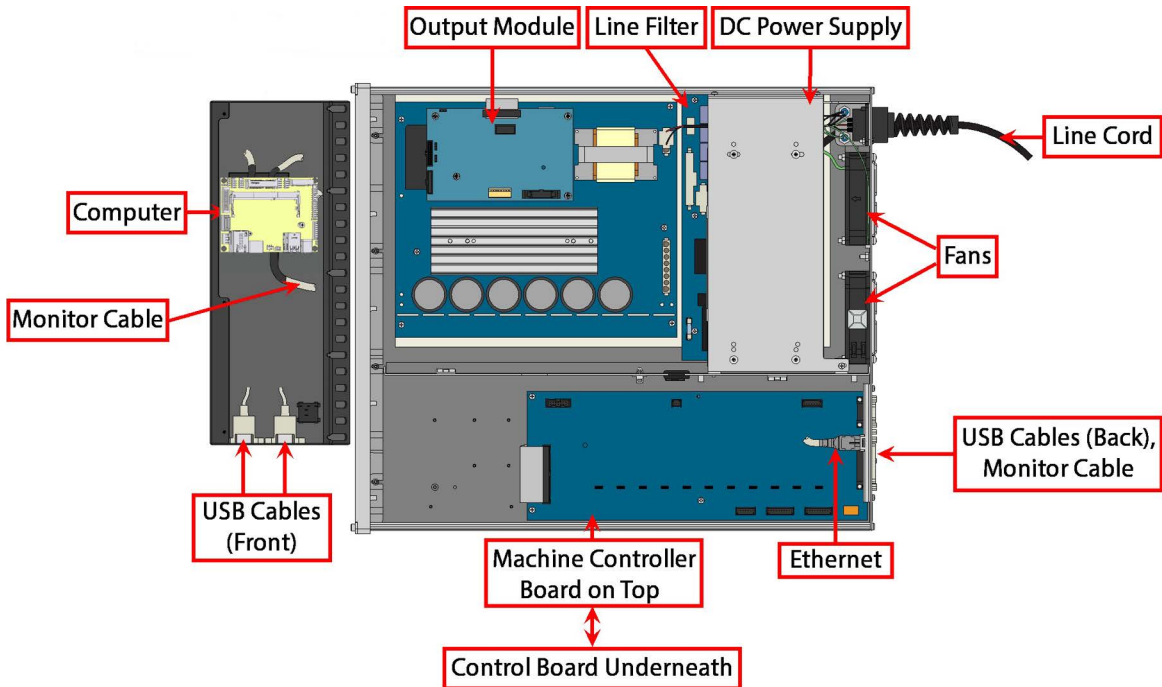

**Table 6.1** Suggested Spares

Description	Part Number
Control Board <sup>1</sup>	102-242-1272R
Machine Controller Board	102-242-968
DC Power Supply	200-132-294R
Line Filter	100-242-1199R (100-242-1230R for 4 KW units only)
Output Module <sup>2</sup>	Call Branson
Fan	100-126-015R
Line Cord	100-246-947
Touchscreen Monitor	BU-1039160
Monitor Cable	BU-1039334
Computer	Call Branson
Ethernet	Call Branson
USB Cables (front)	BU-1039342
USB Cables (back)	BU-1039343

<sup>1</sup>Please go to "About Branson" on the Help dropdown menu for software version and controller version.

<sup>2</sup>Have power supply wattage and frequency available for customer service.

## 6.4 Parts Replacement

CAUTION	
	The Branson VersaGraphix Controller contains components that can be degraded or damaged by electrostatic discharge. Always use a Grounded Wriststrap and use a grounded work area when handling or servicing the VersaGraphix.

The VersaGraphix is designed for a long service life. In the event the system malfunctions, many of the internal components (Modules) are replaceable as a unit. If a particular module has failed, it should be replaced or repaired at an Branson Depot Facility.

NOTICE	
	When the battery is worn out, dispose it under the ordinance of each local government.

## 6.5 Troubleshooting

When the Branson VersaGraphix Controller encounters a situation that is outside normal conditions, an alarm is generated. If there is any alarm condition, the Touchscreen displays an alarm message and generates an audible alarm (see [Table 6.2 System Alarms, with probable cause and corrective action](#)). If you use the Emergency Stop button to terminate a weld, the welder will not operate until reset.

### 6.5.1 System Alarms

The following table details alarms that you can encounter on the VersaGraphix, listed alphabetically by the Display Message that is presented on the touchscreen. The message on the touchscreen of VersaGraphix is shown in the first column. The second and third columns indicate the condition that led to the alarm and the corrective action you should take.

**Table 6.2** System Alarms, with probable cause and corrective action

Alarm Message	Cause	Corrective Action
COM port Error		
EMERGENCY STOP ON!	Emergency Stop is active.	Unlock emergency stop button.
FILE ERROR		
Height System Failure	Controller did not see the encoder move 1mm in 1 second.	Check air pressure. Check flow controls.
Highest power is above power maximum	Power result above the maximum quality window.	
Highest power is below power minimum	Power result below the minimum quality window.	
Invalid PASSWORD re-enter data	Wrong password entered.	Enter correct password.
Lock On Alarm	Quality windows exceeded. Part is locked down.	
Password Exists!	Enter different password.	
Power OVERLOAD	Power results above the maximum available power.	
Result is smaller than minimum height	Final height is below quality window.	
Result is taller than maximum height	Final height is above quality window.	
Safety System Abort!	Safety system.	
Weld longer than maximum time	Weld cycle too long.	Check for parts contamination. Make sure correct preset is used. Check tooling for wear.

**Table 6.2** System Alarms, with probable cause and corrective action

Alarm Message	Cause	Corrective Action
Weld shorter than minimum time	Weld cycle too quick.	Check proper preset is used. Check air pressure. Check correct parts are being welded.
Insufficient storage	Memory has reached 90% of capacity.	Transfer the History files to an external drive.

### 6.5.2 Safety Circuit Alarms

The Safety Control System within the Controller constantly monitors the system's safety related components for correct operation. When this system detects a fault condition, operation is interrupted and the system immediately goes to a safe state. A beeper is used to signal a safety system alarm.

Use the following procedure to troubleshoot safety circuit alarms:

1. Verify that the 9-pin footswitch cable is properly connected to the back of the Controller.
2. Power down and then power up the Controller to reset the system.
3. If the alarm persists, call Branson Support. See [1.5.3 Contact Information](#).

## 6.6 Service Events

WARNING	
	<p>Service events should be performed only by qualified individuals. The potential for injury or death exists, as well as that for damage to the equipment (which can include loss of product warranty) or loss of valuable setup information for your application.</p> <p>When servicing the system, the service person(s) can have a need for certain conventional hand tools, and you might need to have the following information for testing or returning the system to service.</p>

### 6.6.1 Required Tools

Special tools for the ultrasonic Converter, such as spanner wrenches, are provided with your system. You might also need the following hand tools or service tools:

- Six-inch or longer Phillips-head screwdriver with a magnetic tip or screw starter
- Good-quality multi-meter for continuity, AC and DC voltages, and resistance, with insulated test probes

### 6.6.2 Cold Start Procedure

The VersaGraphix's internal memory stores the system default settings and the parameters that you set. It also provides temporary storage to support the Controller's internal functions. A Cold Start clears Battery Backed RAM (BBR) values and restores them to their original factory defaults. It is not necessary to perform a cold start during normal operation and servicing, but you might find a cold start helpful when:

- You suspect the system is not operating properly
- You want to reset the system to its factory default setup

#### 6.6.2.1 Performing a Cold Start

NOTICE	
	<p>Before performing a cold start, the power supply power rating and maximum amplitude should be written down. This information will be needed for input after clearing the BBR. It can be found in the Maintenance Screen under Test Sonics.</p>

To perform a Cold Start touch the Init BBR button on the Options tab in the Administrator screen (see [6.6.4.1 Administrator Options Tab](#)). Once a cold start is performed the Height needs to be recalibrated, along with reinstating the calibrated amplitude and power rating.

### 6.6.3 Maintenance Screen

Figure 6.2 Maintenance Screen

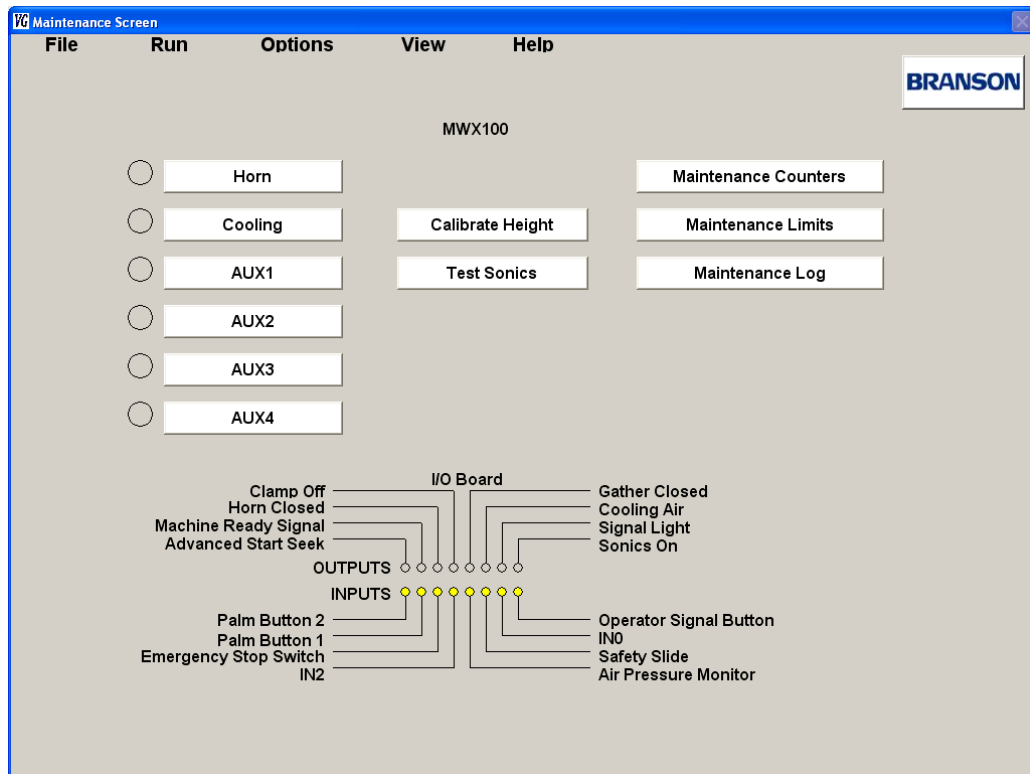

The maintenance screen allows the adjustment and on-demand control of electromechanical devices in your actuator. This screen also allows you to clear maintenance counters, set maintenance limits and make entries to the maintenance log.

The left hand set of buttons have indicators associated with them. Touching each of these buttons allows you to:

**Horn:** Toggle the horn between the up and down positions.

**Cooling:** Toggle the cooling air control solenoid on and off.

**Aux 1-Aux 4:** Toggle auxiliary actuators (used on special equipment). You may rename the auxiliary buttons in order to describe their given function (see [6.6.4 Administrator](#) for more information on renaming auxiliary buttons).

The indicators under the **I/O BOARD** label show the current state of digital inputs and outputs.

## 6.6.3.1 Calibrate Height

Figure 6.3 Height Calibration

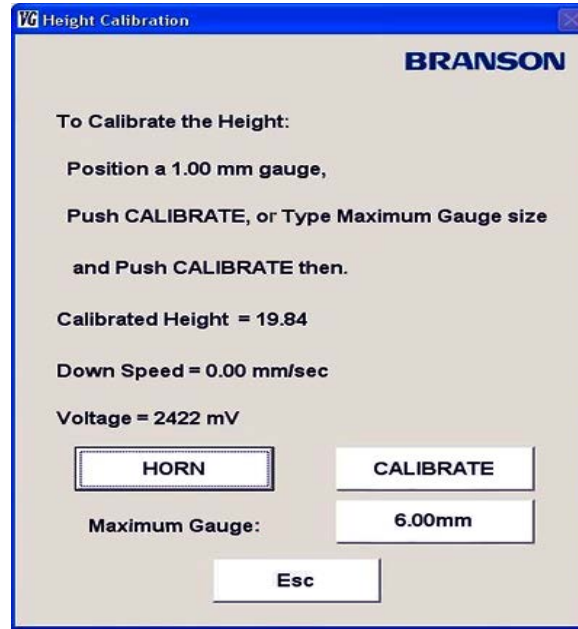

This window is used to perform a height (from horn to anvil) calibration. The instructions on screen explain the calibration procedure.

The following buttons are used to perform a height calibration:

**Horn:** To move the horn up and down against the anvil.

**Calibrate:** To calibrate the height.

Press the **ESC** button to return to the Maintenance Screen.

**Maximum Gauge:** To set up the second gauge. Default setting is 6mm. If entered a value which is out of range, a alarm message will show up.

### 6.6.3.2 Test Sonics

**Figure 6.4** Test Sonics

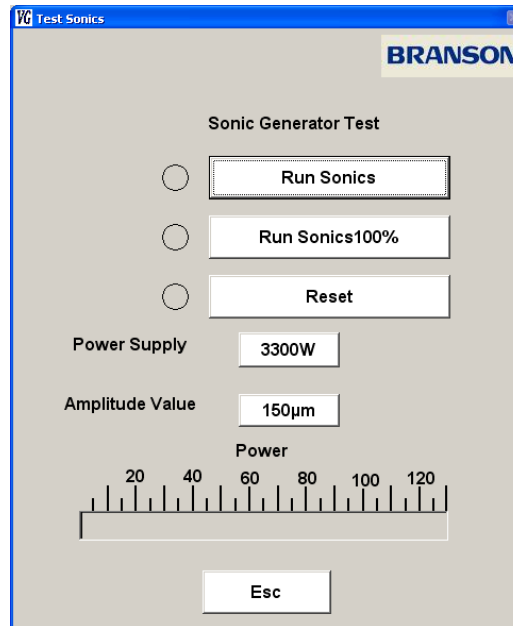

This screen allows the on-demand control of ultrasonic weld energy and the calibration of amplitude.

Amplitude calibration requires a dial indicator to be temporarily mounted in line with, and in front of, the horn, usually on a magnetic base. The Run Sonics 100% is held and the gage reading is viewed.

The gage reading x2 = total amplitude, this is the value to be entered as the amplitude value when calibrating.

The following buttons are used to test the Power supply and to calibrate the amplitude:

**Run Sonics:** Used to fire ultrasonic energy at the current amplitude setting.

**Run Sonics 100%:** Used to fire ultrasonic energy at 100% amplitude. Used when calibrating amplitude.

**Power supply button:** This value is set by Branson for a given actuator and should not be changed. Generally the setting for 20 kHz actuators is 3300W and the setting for 40 kHz actuators is 800W.

**Amplitude Value Button:** Used to set the amplitude value based on the gage reading. See above.

Press the **ESC** button to return to the Maintenance Screen.

## 6.6.3.3 Maintenance Counters

Figure 6.5 Maintenance Counters

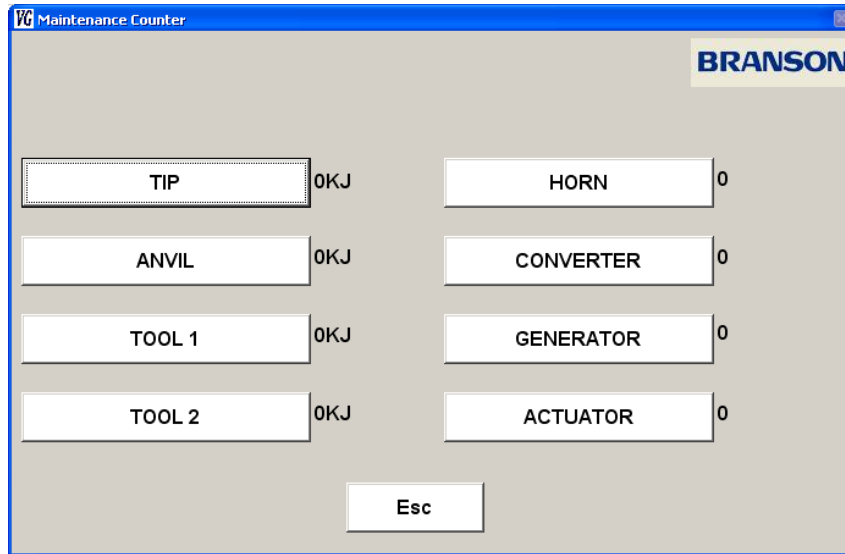

The lifetime of certain parts of your Branson system is based on the number of weld cycles performed, or the energy delivered for welding. Other parts require periodic maintenance depending on the number of cycles performed, or the energy delivered for welding. Maintenance Counters allow you to easily keep track of your system's maintenance requirements.

Maintenance counters and Maintenance limits are related. They are used in conjunction to schedule component maintenance or replacement. Maintenance counters increment after each weld cycle up to the limits set by the user on the Maintenance Limits screen. When a limit is exceeded the VersaGraphix will display warning on screen the next time it is turned on. Any maintenance counter whose value is less than its corresponding limit does not produce an alarm. See section [6.6.3.4 Maintenance Limits](#) for more information on maintenance limits.

The maintenance counter window allows you to reset the counters to zero. Touch the name of the counter you want to reset (you will be prompted to confirm).

A maintenance counter should be reset after a maintenance is performed on the part it relates to.

Press **ESC** to return to the maintenance screen.

### 6.6.3.4 Maintenance Limits

**Figure 6.6** Maintenance Limits

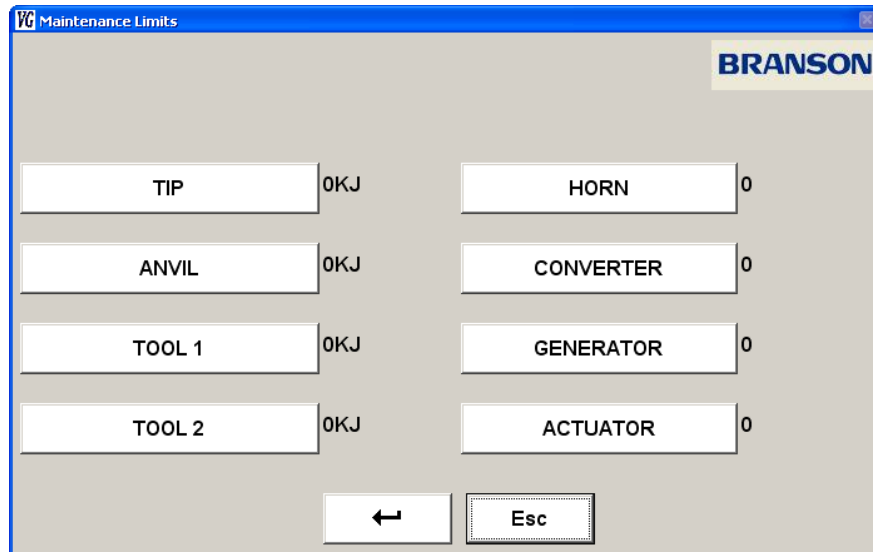

The lifetime of certain parts of your Branson system is based on the number of weld cycles performed, or the energy delivered for welding. Other parts require periodic maintenance depending on the number of cycles performed, or the energy delivered for welding. Maintenance Counters allow you to easily keep track of your system's maintenance requirements.

Maintenance counters and Maintenance limits are related. They are used in conjunction to schedule component maintenance or replacement. Maintenance counters increment after each weld cycle up to the limits set by the user on the Maintenance Limits screen. When a limit is exceeded the VersaGraphix will display warning on screen the next time it is turned on. Any maintenance counter whose value is less than its corresponding limit does not produce an alarm. See section [6.6.3.3 Maintenance Counters](#) for more information on maintenance counters.

The **Maintenance Limits** window allows you to set the maintenance limits for the listed items. Touch the name of the counter limit you want to set and a numeric keypad will pop up so you can set the counter limit. If a limit is set to 0 the controller will not yield an alarm for the counter regardless of its maintenance count.

The left side counter limits for the Tip, Anvil, Tool 1 and Tool 2 are set in kilo-joule units. For example, if the energy weld setting in use is 1500 joules, a limit setting of 7500 kilo joules will produce about 5000 cycles before reaching its limit. The Tool 1 and Tool 2 counters may be used to represent any special fixture tooling.

The right side counter limits on the window for the Horn, Converter, Generator (ultrasonic power supply), and Actuator are set in number of weld cycles.

Press the enter button to save the changes.

Press **ESC** to return to the maintenance screen without saving the changes.

## 6.6.3.5 Maintenance Log

Figure 6.7 Maintenance Log

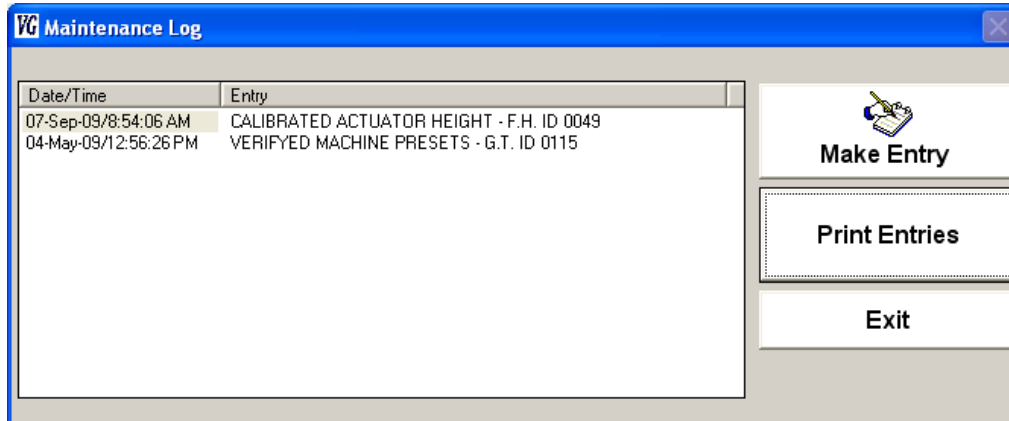

The VersaGraphix has a built in Maintenance log that allows you to keep track of maintenance or testing done to your system.

On the Maintenance Log pop up window you can make entries to the controller maintenance log. Entries are limited to 100 characters per entry. You may also generate a printout of all currently stored entries.

## 6.6.4 Administrator

On the Administrator screen you can perform a system Cold Start; exit the VersaGraphix software; shut down the system; and manage password requirements and screen access permissions.

NOTICE	
	The Administrator screen can only be accessed by entering the Administrator Password. The default Administrator password is <b>ADMIN</b> .

### 6.6.4.1 Administrator Options Tab

**Figure 6.8** Administrator Options Tab

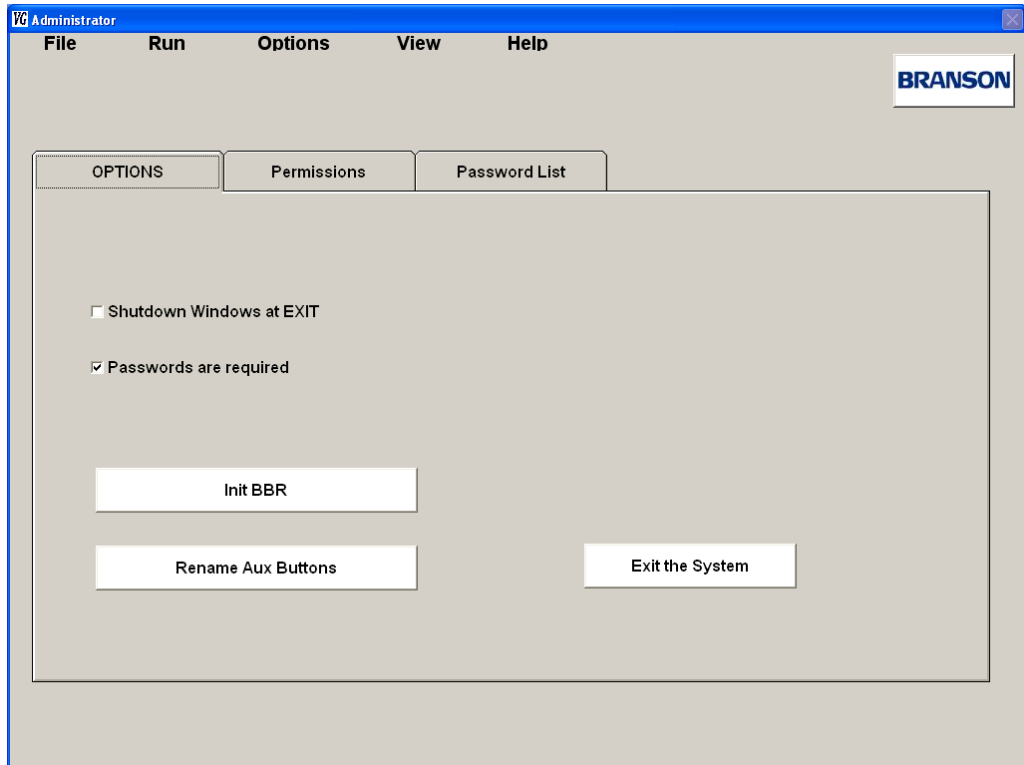

On this Tab you have the following check boxes and buttons:

**Shutdown Windows at EXIT:** Set this checkbox if you want the system to shut down when the Exit System button is pressed. If left unchecked the Software will give control to windows when the Exit System button is pressed.

**Passwords are required:** Set this checkbox to make passwords required when accessing the Maintenance, Setup, Configuration, Create Preset/Sequence, Edit Preset/Sequence, and Teach Mode screens, as set on the Permissions tab. See section [6.6.4.2 Administrator Permissions Tab](#).

**Init BBR:** Touch the Init BBR button to perform a Cold start. Touching this button resets the VersaGraphix's BBR (Battery Backed Ram) to its initial factory defaults. See section [6.6.2 Cold Start Procedure](#) for more information on performing a Cold Start.

NOTICE	
	<p>Before performing a cold start, the power supply power rating and maximum amplitude should be written down. This information will be needed for input after clearing the BBR. It can be found in the Maintenance Screen under Test Sonics.</p>

**Rename Aux Buttons:** Touching this button will cause the Rename Aux Buttons window to pop up. On this Window you may rename the four Auxiliary buttons shown on the maintenance screen. These buttons are used to control additional actuators on special systems in order to perform maintenance activities. See [6.6.3 Maintenance Screen](#).

**Figure 6.9** Rename Aux Buttons

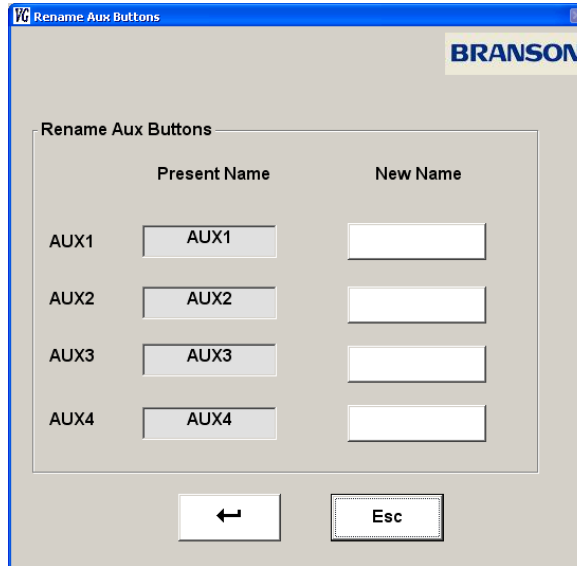

**Exit the system:** Touch this button to exit the VersaGraphix’s software. If the Shutdown Windows at EXIT checkbox is checked, the system will shut down completely. If left unchecked, the software will exit and give control to the Windows OS.

## 6.6.4.2 Administrator Permissions Tab

**Figure 6.10** Administrator screen

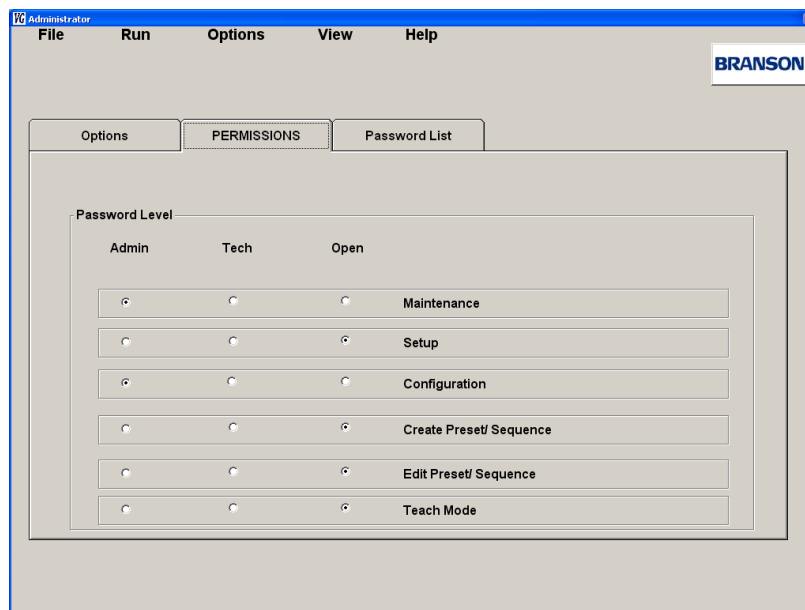

On this tab you can assign password requirements for the Maintenance, Setup, Configuration, Create Preset/Sequence, Edit Preset/Sequence, and Teach Mode screens. There are three possible security levels you can assign to these screens:

**Open:** Set the radio button to Open to make this screen accessible without a password.

**Tech:** Set the radio button to Tech to make this screen accessible using either the Technician or Administrator passwords.

**Admin:** Set the radio button to Admin to make this screen accessible only by using the Administrator password.

### 6.6.4.3 Administrator Password List Tab

Figure 6.11 Administrator Password List Table

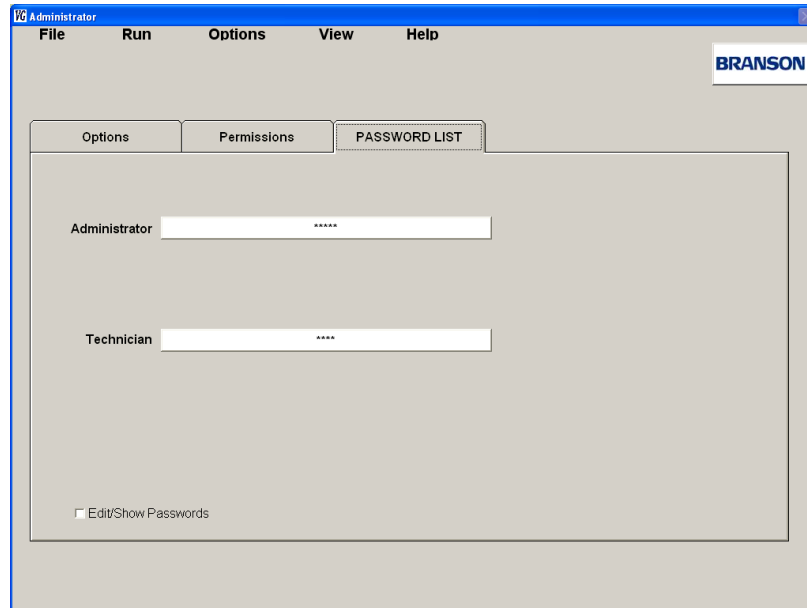

On this tab you may edit Both the Administrator and Technician passwords. First you must check the Edit/Show Passwords check box, to make the passwords visible and editable. Having this checkbox unchecked protects the passwords from being modified.

NOTICE	
	The default Administrator password is <b>ADMIN</b> .

